

Fuji

POWER
AND PRECISION
IN PERFECT
HARMONY

INDUSTRIAL TOOLS



J A P A N E S E Q U A L I T Y S I N C E 1 9 4 3



FUJI TOOLS

Power and Precision in Perfect Harmony



**INDUSTRIAL TOOLS.
JAPANESE QUALITY
SINCE 1943**

A DEEP JAPANESE HERITAGE



From the beginning, Fuji has manufactured tools for some of the toughest and most demanding industrial environments in Japan and on the planet. This has resulted in a wide range of robust and long lasting material removal tools that is the preferred choice for metalworking in Japan and many places overseas. Our range of assembly tools and error proofing solutions was born from the needs of the Japanese manufacturing industry and delivers quality and safety together with speed of operation and ergonomic handling.

COMMITMENT TO QUALITY AND TECHNOLOGY



Every Fuji tool, from the simplest to the most sophisticated, is built to the same exacting standards. "Monozukuri", Japanese craftsmanship, is a core value in both manufacturing and design. Over 60 years of non-stop investment in R&D and kaizen manufacturing ensures that our products are built using proven, advanced technologies and provide superior ergonomics, safety and handling. Moreover, our commitment extends beyond our products to include the world we live in. Our production facilities are compliant with both the ISO 9001 and ISO 14001 standards.



**QUALITY
GUARANTEED**

**OUR COMPANY
IS CERTIFIED ISO 9001
QUALITY MANAGEMENT
AND ISO 14001
ENVIRONMENTAL
MANAGEMENT
STANDARDS.**



WIDE RANGE OF STANDARD AND SPECIAL PRODUCT

With a catalogue of over 1,400 references, we have one of the most extensive, most cost effective ranges of industrial tools available today. Our engineering team also has a long history of collaborating with customers to design solutions for special needs, both large and small.

COMMITTED TO LONG TERM CUSTOMER SATISFACTION

Fuji Tools are available through our network of authorized distributors that provide highly reactive after-sales service. They ensure that after years of service our products perform just as well as on day one. We support this network through both a dedicated international team in Japan and local market representatives in over 20 countries.



Check out today our mobile eCatalog on m.fujitools.com



Need to know more?

> www.fujitools.com



> www.linkedin.com/company/fuji-air-tools

SELECTION GUIDE

How to understand Fuji model numbers

The model number of Fuji tools is formed by three elements of a combination of letters and numbers indicating the various properties and characteristics of tools concerned.

The first combination of letters indicates the group category that the model belongs to. "FRD" of the model FRD-6PH-3, for example, indicates that this model belongs to the group of "Fuji Rotary Drill".

The second part "6PH" shows the capacity in numbers like wheel size, bolt size, horse power etc. and also shows the types of throttle handle, exhaust direction and housing etc. in letters. In this case, "6" indicates drilling capacity and "PH" indicates pistol handle and rear exhaust.

The third part "3" shows the generation of models in numbers and types of handle, length of anvil and driver bit etc. in letters.

TORQUE TESTERS

FDM	Fuji Digital Tachometer
FDT	Fuji Digital Torque Tester
FFA	Fuji Fastening Adapter
FJT	Fuji Hydraulic Torque Tester
TT	Torque Transducer

WRENCHES, SCREWDRIVERS

CA	Corner Attachments for Impact Wrenches
FD	Fuji Screwdrivers
FET	Fuji Electronic Torque Control Pulse Wrenches
FOW	Fuji Open Ratchet Wrenches
FLT/FPT	Fuji Mechanical Shut-off Pulse Wrenches
FL/FPW	Fuji Pulse Wrenches
FRW	Fuji Ratchet Wrenches
FW	Fuji Impact Wrenches

GRINDERS - SANDERS

FA	Fuji Angle Grinders
FBS	Fuji Belt Sanders
FG	Fuji Die Grinders or Straight Grinders
FOS	Fuji Orbital Sanders
FOR	Fuji Orbital Sanders (Random)
FV	Fuji Vertical Grinders
TURBO	Turbo Ginder

DRILLS - TAPPERS

FCD	Fuji Corner Drills
FRD	Fuji Rotary Drills
FT	Fuji Tappers

HAMMERS - CHIPPERS - RAMMERS

FC	Fuji Calking Hammers
FCH	Fuji Chipping Hammers
FNS	Fuji Needle Scalers
FR	Fuji Rammers
FRH	Fuji Riveting Hammers
FS	Fuji Scaling Hammers

OTHER PRODUCTS

FBM	Fuji Pipe Beveling Machines / Chamfering Machines
FJP	Fuji Jet Pumps
FM	Fuji Air Motor
FP	Fuji Pumps
FRF/FRS	Fuji Reciprocating File & Saw
FTD	Fuji Tip Dressers

SELECTION GUIDE

PULSE WRENCHES

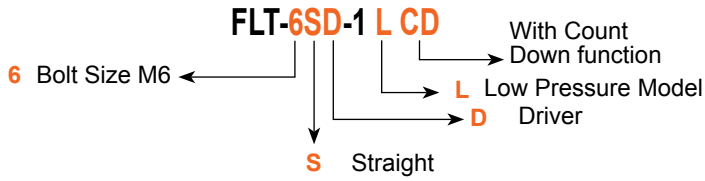

IMPACT WRENCHES

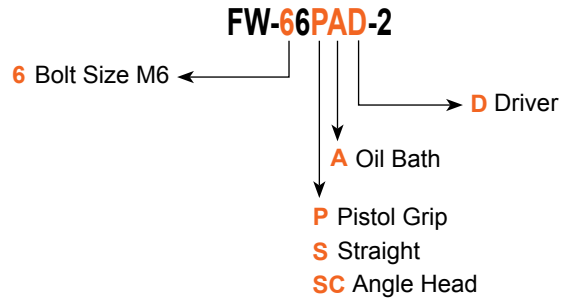

RATCHET WRENCHES

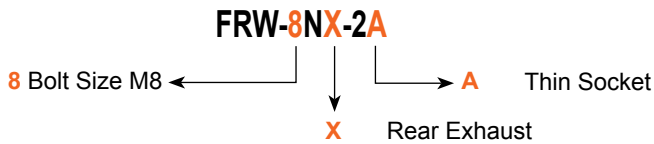

DIE GRINDERS

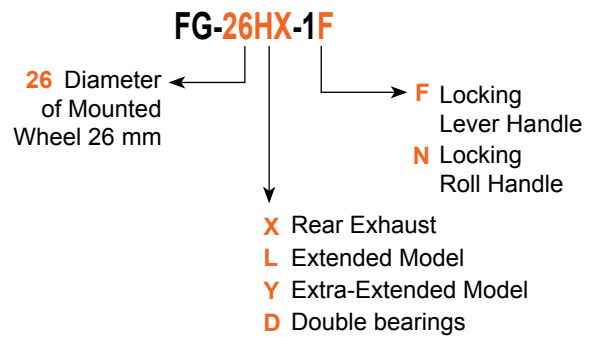

STRAIGHT - EXTENDED GRINDERS

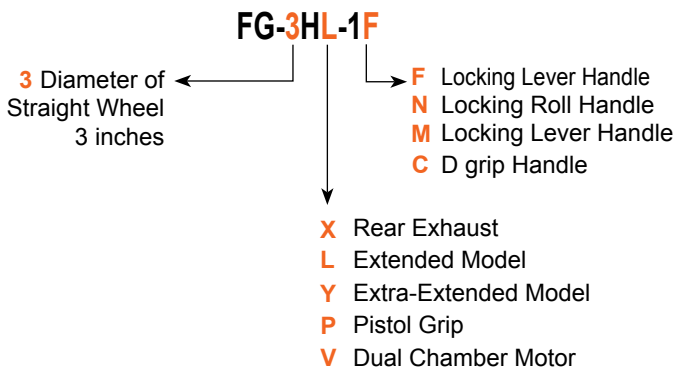

ANGLE GRINDERS - SANDERS



VERTICAL GRINDERS

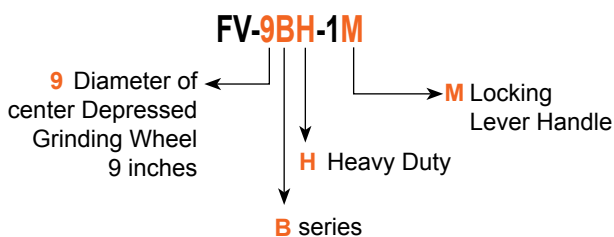

ORBITAL SANDERS

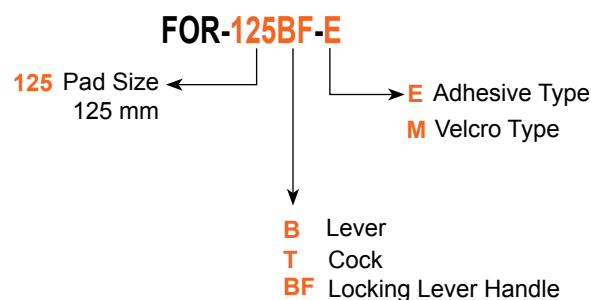

SELECTION GUIDE

DRILLS

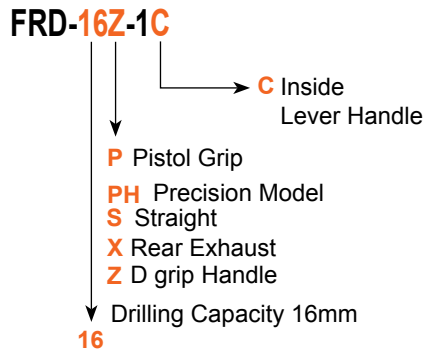

TAPPERS

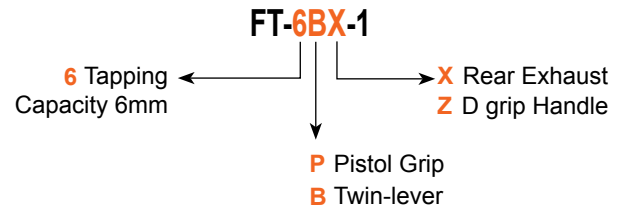

CHIPPING HAMMERS

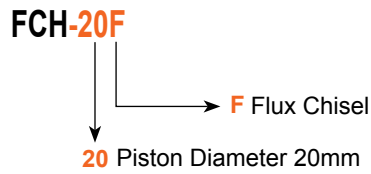

CALKING HAMMERS

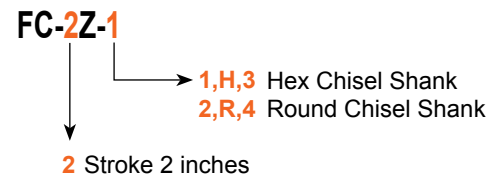

LIGHT HAMMERS

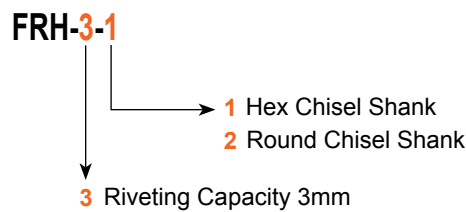

RAMMERS

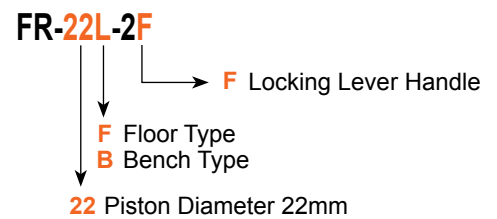

SELECTION GUIDE

AIR MOTORS

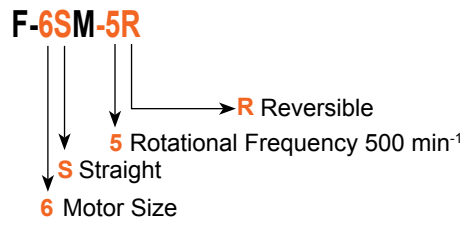

PUMPS

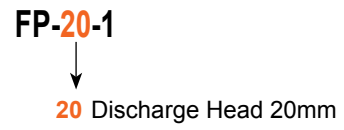

PIPE BEVELLING MACHINES

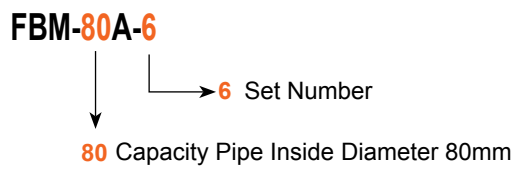

SELECTION GUIDE

About The Specifications on Our Catalogue

- 1) **Use the 10 digit** ordering numbers found in the tool selection guide when ordering.
- 2) **Bolt Size, Capacity**
Shows the capacity, which the tool can handle, as guidance for a tool selection. The bolt size of a fastening tool is a bolt size which the tool may fasten.
The capacities shown on this catalogue - tapping capacity, riveting capacity, etc. show the size which the tool may handle. Be aware, that the capacity may vary depending on such conditions as the tension, joint rate, material, etc. of the work.
- 3) **Recommended Torque Range, Max Torque**
Shows recommended torque range or max torque of the model. Torque figures in the specifications must be used as guidance only, as final output depends on type and size of fastener, joint rate and air pressure etc.
- 4) **Rotational Frequency**
Rotational frequency is indicated in revolutions per minute, min-1 at which the tool runs at no load at the working air pressure of 0.63MPa, 6.3bar, 90psi if not otherwise specified.
- 5) **Overall Length**
Shows the longest part of the tool without accessories attached. Refer to the last part of this catalogue «Dimensions» if the details of dimensions are necessary.
- 6) **Mass**
Shows the mass of the tool without accessories.
- 7) **Square Drive Size, Bit Shank Size**
Square drive size shows the square size of the spindle or anvil of pulse wrenches and impact wrenches. Bit shank size indicates the bit shank size of the driver anvil of screw drivers.
- 8) **Hex. Socket Size**
Shows standard hexagonal size of the socket of the ratchet wrenches.
- 9) **Air Inlet Thread Size**
Female threaded PT (Pipe Threads) and NPT (National Pipe Threads) are available.
- 10) **Air Hose Size**
The air hose size indicates recommended minimum hose inside diameter which is necessary to supply enough volume of air to the tool for designed performance.
- 11) **Air Consumption**
The air consumption of the tools is stated in m³/min, cubic meters per minute. It indicates the maximum air consumption at the working air pressure 0.63MPa, 6.3bar, 90psi if not otherwise stated.
Maximum air consumption is valid for the tool without a speed governor when the tool is running at no load.

Conversion Factors

Length	1 m	=1000 mm	=39.4 in	=3.28 ft
Diameter, Width, Depth, Height	1 in	=25.4 mm	=0.0254 m	=0.0833 ft
Thickness, Lift, Size	1 cm	=10 mm	=0.394 in	
Side to Center	1 ft	=12 in	=0.3048 m	=304.8 mm
Capacity				
Stroke				
Mass	1 kg	=1000 g	=2.20462 lb	
	1 lb	=0.45359237 kg		
Torque	1 N • m	=0.7375 ft • lb	=0.102 kgf • m	
Recommended Torque Range	1 kgf • m	=9.807 N • m	=7.233 ft • lb	
Max. Torque, Measuring Range	1 ft • lb	=1.3558 N • m	=0.138 kgf • m	
Stall Torque, Starting Torque				
Force	1 N	=0.102 kgf	=0.225 lbf	
Lifting Capacity	1 kgf	=9.807 N	=0.205 lbf	
	1 lbf	=4.448 N	=0.454 kgf	
	1kN	=1000 N	=102 kgf	
Pressure	1 Pa	=1 N/m ²		
Air Pressure	1 bar	=100 kPa	=0.1 MPa	=1.0197 kgf/cm ²
Vacuum Degree	1 MPa	=10.2kgf/cm ²	=10 bar	
	1 kPa	=0.01 bar	=0.0102 kp/cm ²	=7.5 mmHg
	1 kp/cm ²	=98.07 kPa		
Power	1 W	=0.102 kgf • m/s	=0.738 ft • lb/s	
Power Consumption	1 W	=1 J/s	=1 N • m/s	=1VA
Motor Output, Horse Power	1kgf • m/s	=9.807 W	=0.0133 PS	=7.233 ft • lb/s
	1 PS	=75 kgf • m/s	=0.7355 kW	
	1 kW	=1000 W		
Volume	1 m ³	=35.3 ft ³		
	1 m ³	=1000 l	=1 k	
	1 l	=1000 cm ³	=0.001 m ³	
	1 ft ³	=28.3		
Flow Rate	1 m ³ /s	=60 m ³ /min		
Max. Air Consumption	1 m ³ /min	=35.3 ft ³ /min		
Discharge Volume	1 m ³ /h	=16.667 l/min	=0.2778 l /s	
Discharge Capacity	1 m ³ /min	=16.667 l/s		
	1 l/s	=2.1189 cfm		
	1 cfm	=0.4719 l/s		
Velocity	1 m/s	=3.28 ft/s	=3.6km/h	=60 m/min
Rope Speed, Lifting Speed	1 ft/s	=0.3048 m/s	=1.0973 km/h	
Propelling Speed	1 km/h	=0.278 m/s	=0.911 ft/s	
Rotational Frequency	1 s ⁻¹	=60 rpm		
Free Speed, Pinion Speed	1 min ⁻¹	=1 rpm	=Peripheral Speed (m/min) x 1000 π x Wheel Diameter (mm)	(π =3.14)
Measuring Range				
Frequency	1 Hz	=60 bpm	=60 spm	
Blow, Stroke per minute	1 kHz	=1000 Hz		

CONTENTS

9 ASSEMBLY TOOLS

- 10 - Assembly tools selection guide
- 16 - Testers-Oil filler
- 19 - FET Series
- 22 - Pulse wrenches
- 30 - Impact Wrenches
- 35 - Screwdrivers
- 37 - Ratchet Wrenches

41 ABRASIVE TOOLS

- 42 - Safety Use - Features
- 44 - Pencil & Turbo Grinders
- 45 - Die Grinders
- 46 - Die Grinders for Mounted Point
- 49 - Low-Speed & Straight Grinders
- 51 - Extended Grinders
- 53 - Angle Grinders - Small to large
- 59 - Vertical Grinders & Sanders
- 60 - Angle Sanders
- 61 - Belt Sanders
- 62 - Orbital Sanders
- 63 - Accessories

71 DRILLS / TAPPERS

- 72 - Drills Features
- 73 - Drills
- 76 - Baby Angle Drills
- 77 - Corner Drills
- 78 - Accessories
- 79 - Tappers Features
- 80 - Tappers

81 PERCUSSIVE TOOLS

- 82 - Features
- 83 - Flux Chippers - Light Hammers - Chipping and Calking Hammers
- 85 - Needle scalers - Scaling Hammers / Sand Rammers
- 88 - Accessories

91 AIR MOTORS

95 COMPLEMENTARY RANGE

- 96 - Air Files / Air Saws
- 97 - Chamfering / Aluminum Milling Machines
- 98 - Pipe Beveling Machines
- 100 - Sump Pumps / Piston Pumps
- 101 - Tip Dressers
- 102 - Marking Pen / Air Cleaners

103 SERVICE TOOLING

- 104 - Spanners and Wrenches for Maintenance
- 105 - Air Compressor / Air Pressure

106 DIMENSIONS

124 VIBRATION AND NOISE

128 INDEX





ASSEMBLY TOOLS

SELECTION GUIDE	10
ASSEMBLY TOOLS SELECTION GUIDE	14
TESTERS-OIL FILLER	16
FET SERIES	19
PULSE WRENCHES NON-SHUT-OFF TYPE	22
IMPACT WRENCHES	30
SCREWDRIVERS	35
RATCHET WRENCHES	37

SELECTION GUIDE

TIGHTENING TORQUE (N.m)

This table shows the recommended tightening torque for common bolt size M2 to M48.

Bolt Size	Bolt Grade							Bolt Size	Bolt Grade						
mm	3.0	4.6	4.8	5.8	8.8	10.9	12.9	mm	4.6	4.8	5.8	8.8	10.9	12.9	
M2	0.10	0.13	0.17	0.22	0.35	0.49	0.58	M18	103	121	172	275	386	463	
M3	0.35	0.46	0.61	0.77	1.20	1.70	2.10	M20	144	170	240	385	541	649	
M4	0.81	1.10	1.40	1.80	2.90	4.00	4.90	M22	194	230	324	518	728	874	
M5	0.60	2.20	2.95	3.60	5.70	8.10	9.70	M24	249	295	416	665	935	1120	
M6	2.80	3.70	4.90	6.10	9.80	14.0	17.0	M27	360	435	600	961	1350	1620	
M8		8.9	10.5	15	24	33	40	M30	492	590	819	1310	1840	2210	
M10		17	21	29	47	65	79	M36	855	1030	1420	2280	3210	3850	
M12		30	36	51	81	114	136	M42	1360		2270	3640	5110	6140	
M14		48	58	80	128	181	217	M45	1690		2820	4510	6340	7610	
M16		74	88	123	197	277	333	M48	2040		3400	5450	7660	9190	

according to ISO898-1

RECOMMENDED TORQUE RANGE

The torque requirement is one of the major factors to be considered when selecting fastening tools. The following graphic presentation shows the recommended torque range of our assembly tools. This is to be used for guidance only as final torque may vary depending in the type and size of the fastener, the joint rate, air pressure, etc. Optimum performance is achieved at the mid range of the tool's torque capability.

ELECTRONIC TORQUE CONTROL PULSE WRENCHES (P.19)

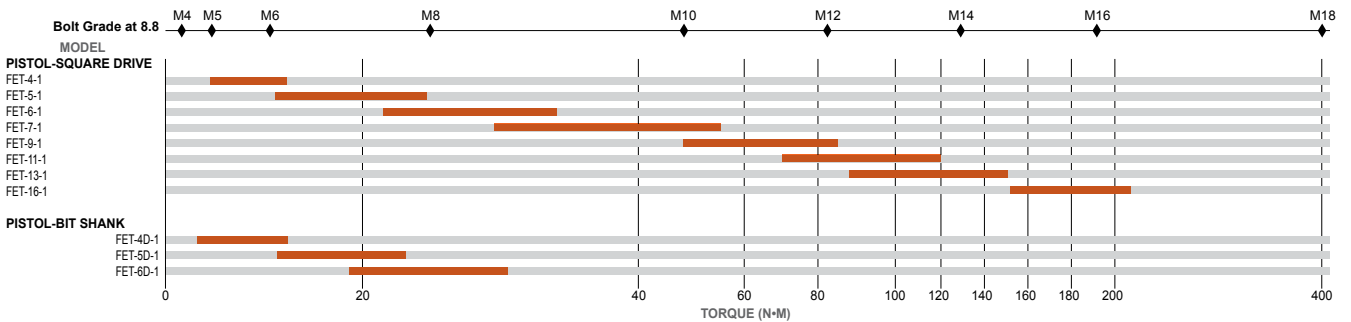

PULSE WRENCHES NON SHUT-OFF TYPE (P.22)

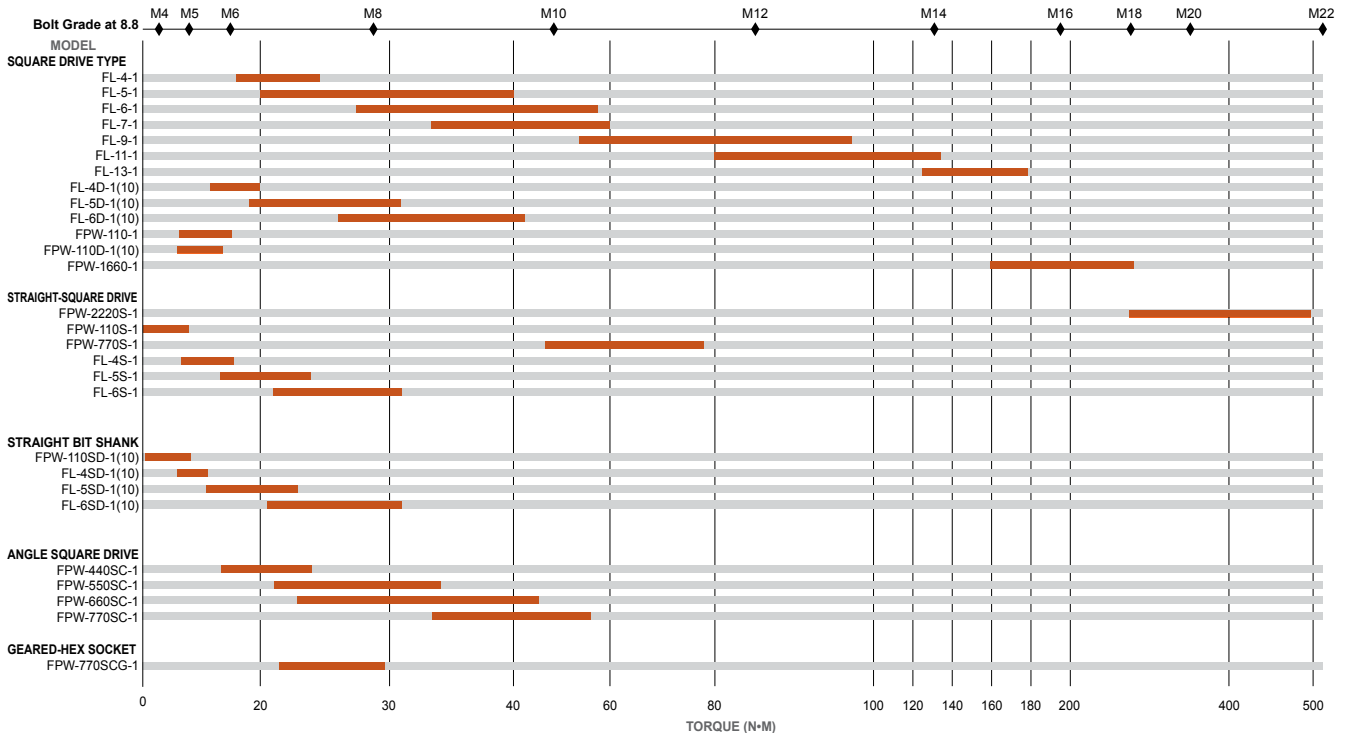

PULSE WRENCHES SHUT-OFF TYPE (P.26)

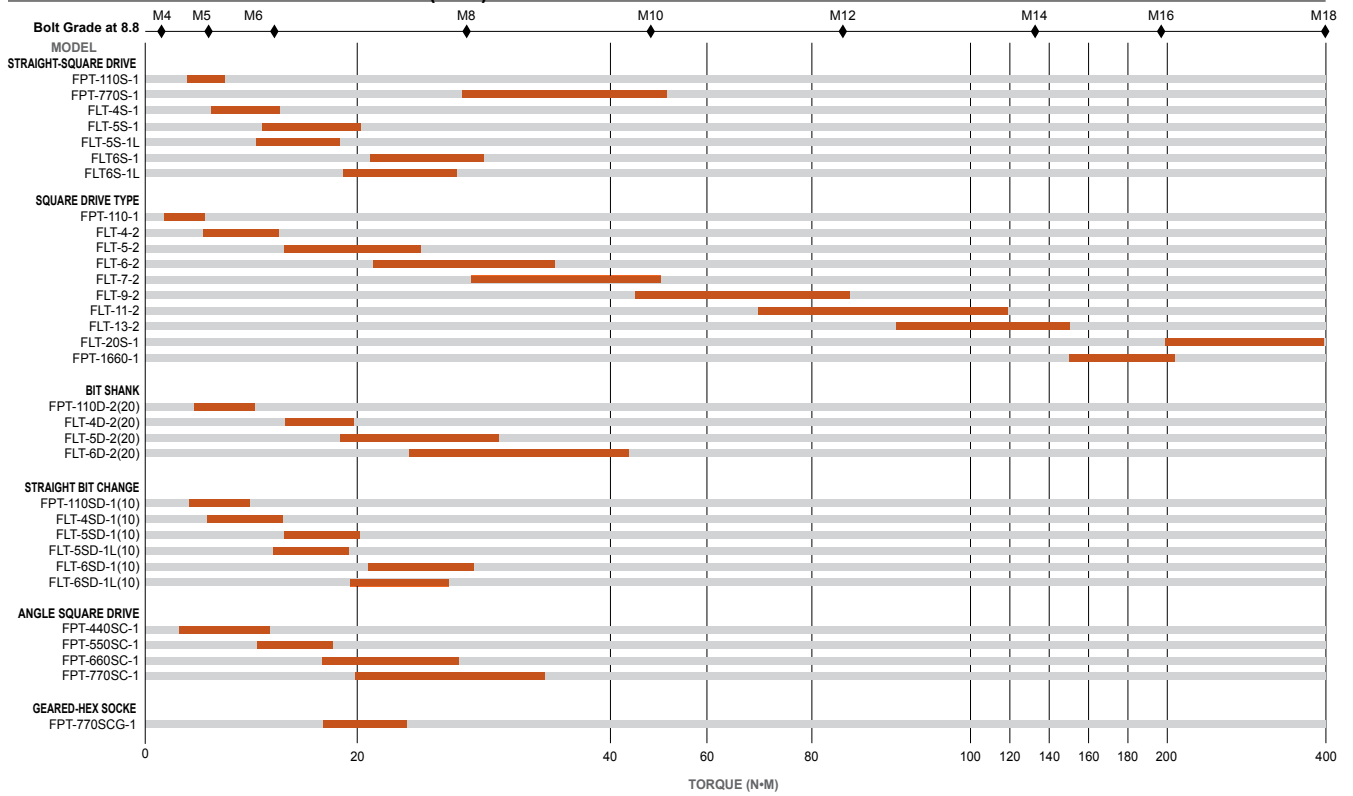

IMPACT WRENCHES - SMALL SIZE (P.30-32)

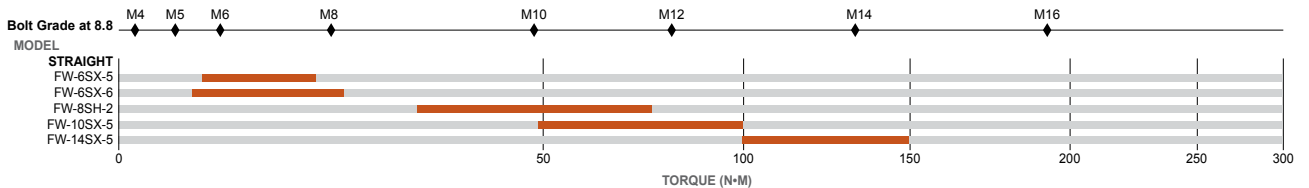
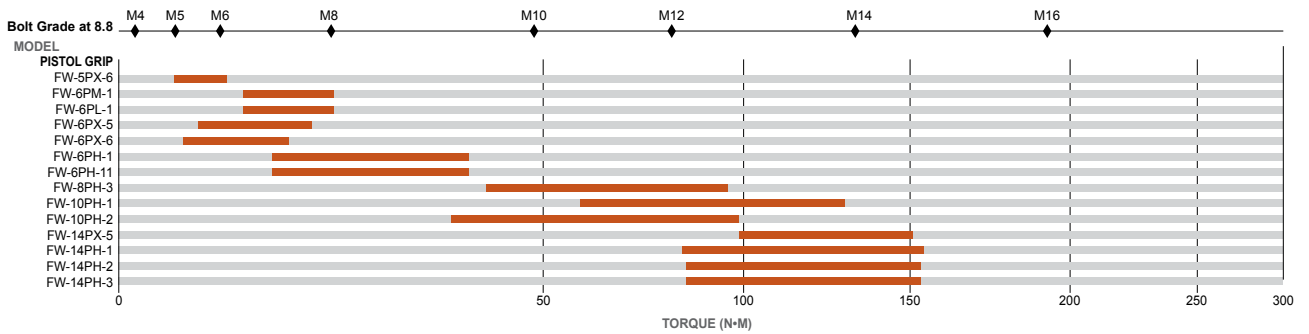
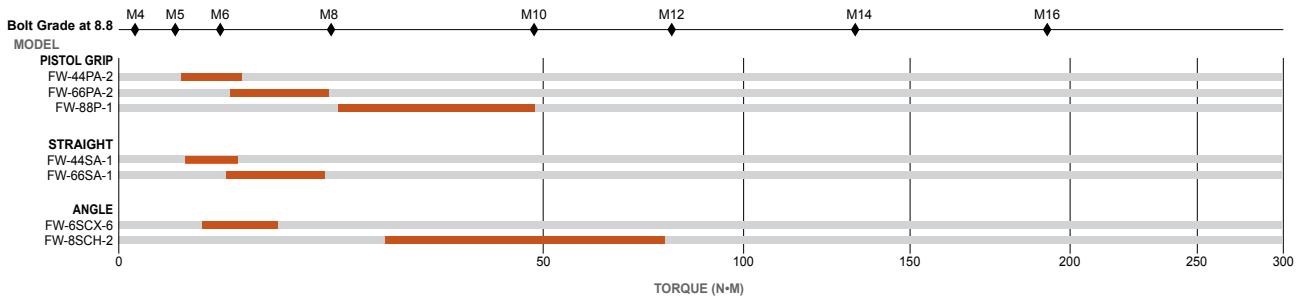

SELECTION GUIDE

IMPACT WRENCHES MEDIUM SIZE (P.33-34)

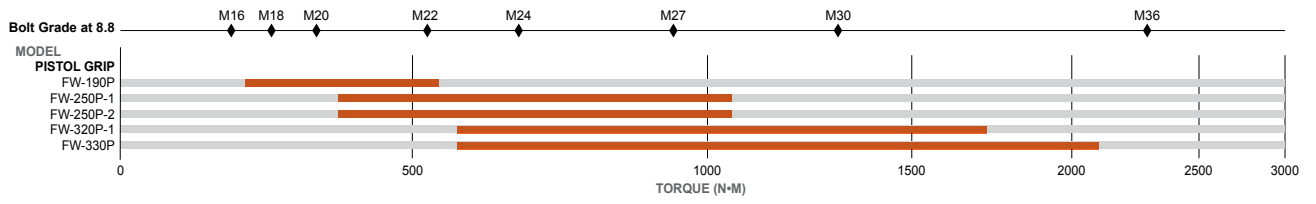
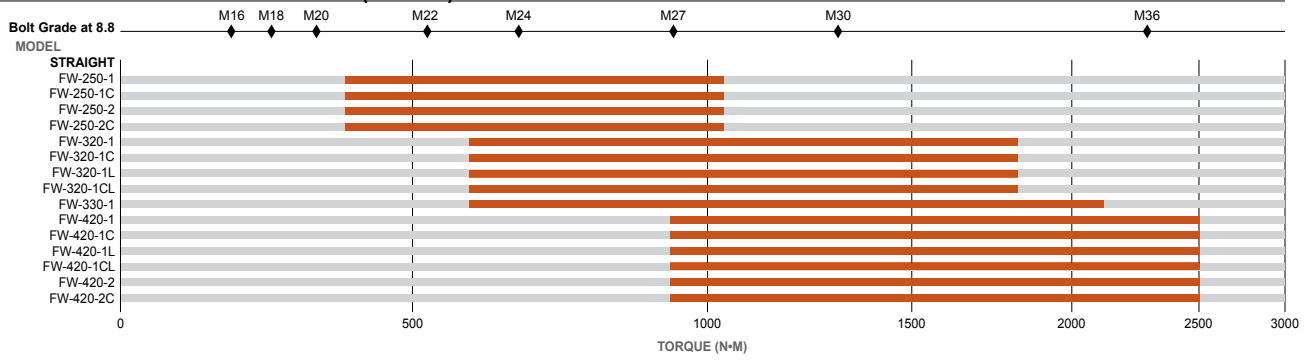

IMPACT WRENCHES LARGE SIZE (P.34)

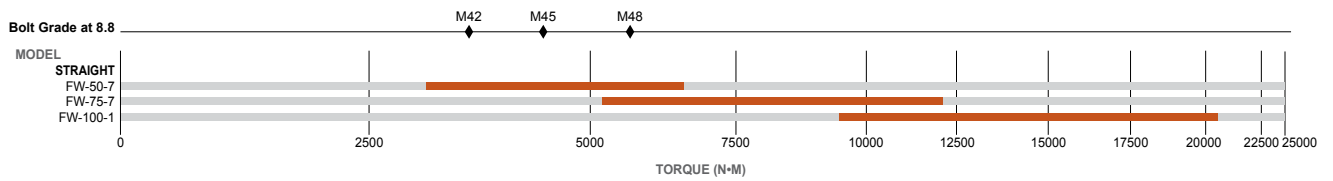

SCREWDRIVERS (P.35-36)

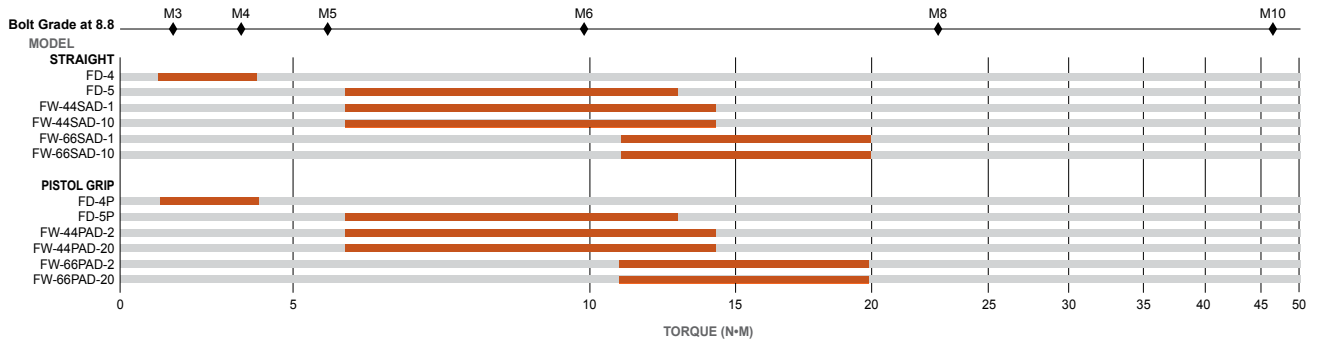
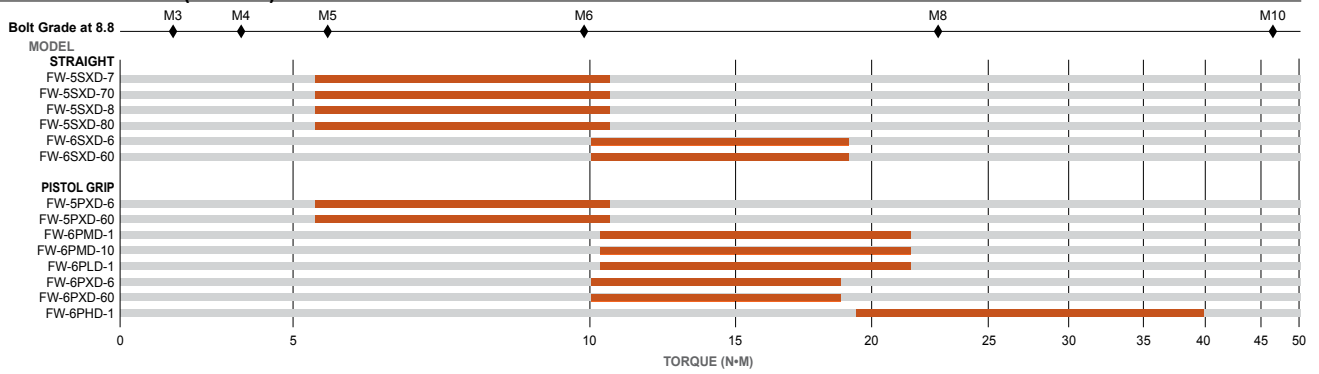

Torque range should be used for guidance only as final torque may vary depending on the type and size of fastener, the joint rate, air pressure etc. Optimum performance is achieved at the mid range of the tool's torque capability

ASSEMBLY TOOLS FEATURES

EXHAUST WITH A MUFFLER

Our original built-in, swivel type, exhaust muffler is designed to reduce the noise level of the tool. The operator can also select a suitable direction of the exhaust air to minimise the risk of blowing any dust or debris in to the local work environment.

ALL WRENCHES EXCEPT FW-6PL, 6PLD, 5SXD-8, 80, FD-4, 5, 4P, 5P

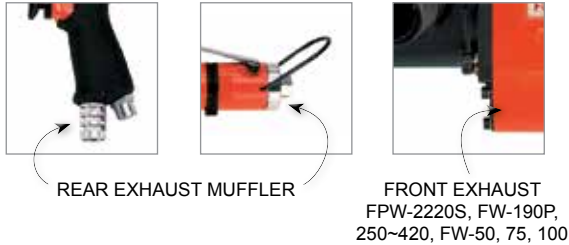

TWO STAGE - SQUEEZING TYPE THROTTLE VALVE MECHANISM

The two stage / squeeze type throttle enables the operator to start the tool slowly and increase to full speed to aid location of the fastening at the start of the cycle.



REVERSE VALVE LEVER

All models feature a reversible motor. The operator can easily and quickly select the direction of rotation simply by turning or sliding the reverse actuator.

ALL WRENCHES EXCEPT FOW, FRW



To accommodate torque adjustment, the built in air regulator is used to regulate the air flow for selected models.

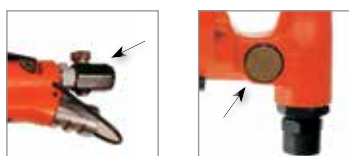

SQUARE DRIVE ANVIL

Two types of square drive anvils are available. As our standard for overseas, the models larger than 25.4 mm (1 inch) square drive are supplied with P anvil (Pin hole retainer type) and the models smaller than 19 mm (3/4 inch) square drive are supplied with BF anvil (Flat button retainer type). Small models can be supplied with P anvil on your request.



BIT SHANK TYPE ANVIL FOR SCREW DRIVERS

Two types of quick-change bit shank type anvils are available. Both are for 6.35 mm (1/4 inch) hex driver bit, but divided into two model groups according to the bit neck size.

ALL SCREW DRIVERS

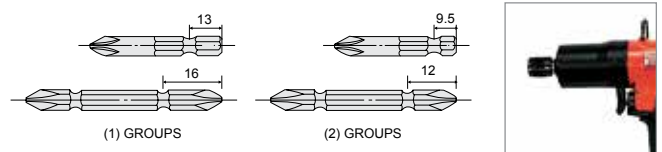

CLUTCH MECHANISM-IMPACT WRENCHES AND DRIVERS

DOUBLE CLUTCH TYPE

The impact force is balanced with less torque reaction due to two impacts made per revolution. The double clutch type impact wrenches and drivers benefit from less vibration and longer service life than conventional single clutch models.

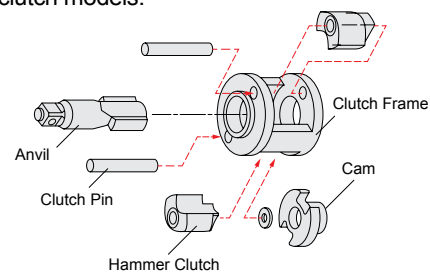

SINGLE CLUTCH TYPE

The impact force is harder and torque/weight ratio is better than the double clutch type. Single clutch type models are suitable for hard «pull-up» fastening operations for maintenance & service applications.

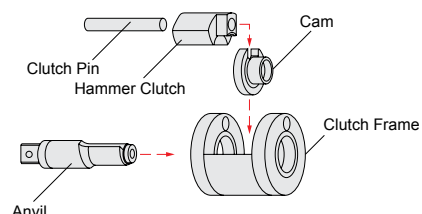

ASSEMBLY TOOLS FEATURES

■ PIN-LESS ROCKING DOG CLUTCH TYPE

The Fuji Pin-less rocking dog impact wrenches generate higher impact force than double clutch or 2-jaw clutch. Thanks to the one body design of pin and hammer, they have very high durability. The best tools for removing corroded fasteners.

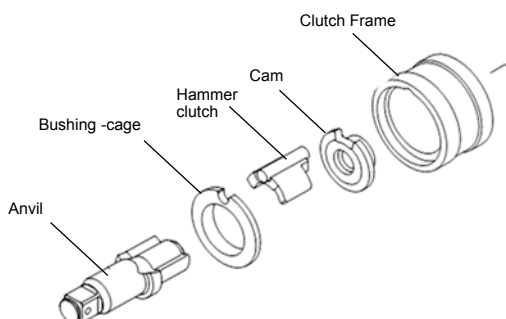

■ 2-JAW ONE-DOG CLUTCH TYPE

The Fuji 2-Jaw clutch impact wrenches generate very high torque/weight. These types of tool are most suited for tightening prevailing torque bolts and for removing corroded fasteners.

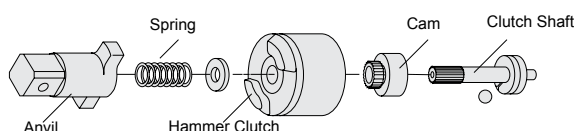

HANDLE PROTECTOR

Ergonomically designed handle protectors provide reduced vibration, increased operator comfort and insulate the hand from the cold temperature generated by compressed air.



DUAL CHAMBER MOTOR

All Fuji pulse wrench models (FET, FLT, FPT, FL, FPW) and the series of impact wrenches (FW-44~88) are built with a 9 blade, dual chamber motor. This motor is designed to provide high torque at low speed, giving the best characteristics for fast reliable and accurate tightening.

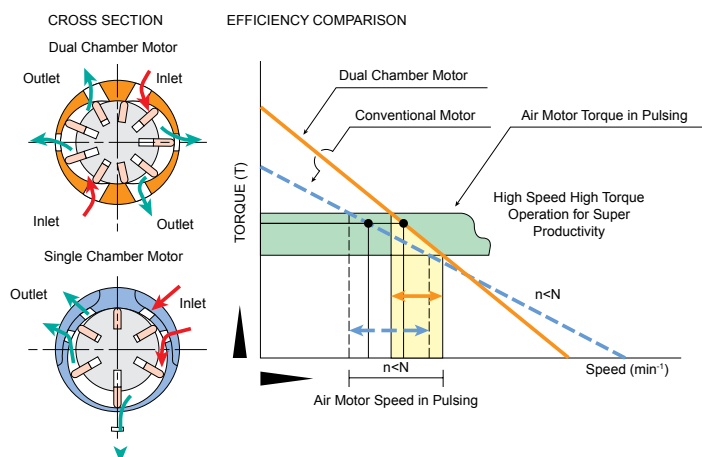

2-BLADE PULSE UNIT

As the pulsing cycle is very short, there is almost no torque reaction in the handle grip (low motor torque only is felt by the operator). Unlike an impact wrench, the pulse tool has no «metal to metal» contact and consequently the pulse wrenches provide softer and stable «impulsing».

The benefits from this are less vibration, lower noise levels and longer service life when compared with conventional impact wrenches.

All pulse wrenches models (FET, FLT, FPT, FL, FPW) utilise the Fuji patented 2 blade pulse unit combined with the dual chamber motor. This combination provides 50% higher power to weight ratio than comparable fastening tools. For productivity, this design reaches torque faster, is excellent for soft joint or prevailing torque applications with reduced noise and vibration levels.

IMPULSING CYCLE
2-BLADE PULSE UNIT
Controllers - Testers

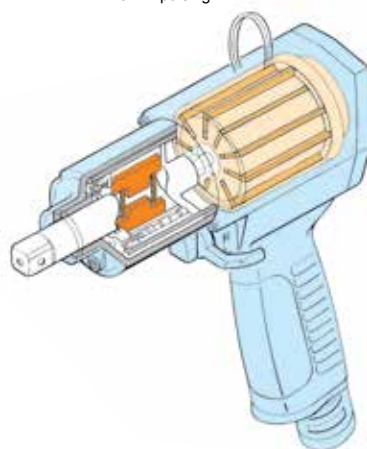
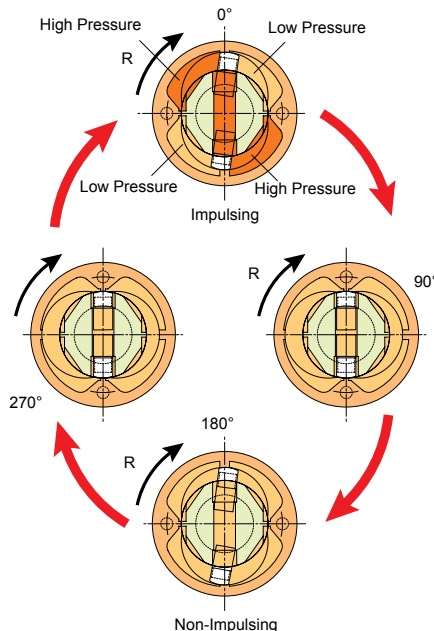

TESTERS

HYDRAULIC TORQUE TESTERS (NOT AVAILABLE FOR CE)



FJT-5-1~5C-1



FJT-10-1~10C-1



FJT-16-1~16C-1

The hydraulic torque testers are designed to satisfy the need for accurate torque checking and adjustment of shut-off type pulse wrenches and screwdrivers.

Features

- Bright LED digital display for easy reading in poor light conditions.
- Easy operation and high precision.
- Joint rate setting (soft joint to hard joint) is applicable

MODEL	Weight		Testing Bolt Size	Measuring Range		
	Kg	lb		mm	N.m	kgf.m
FJT-5-1 4	10.0	22.0	M4	1.6 - 3.2	1.2 - 2.4	
FJT-5-1 5			M5	3.2 - 5.4	2.4 - 4.0	
FJT-5-1 K			M4.5	1.6 - 5.4	1.2 - 4.0	
FJT-10-1 6	11.5	25.3	M6	5.4 - 14.7	4.0 - 10.9	
FJT-10-1 8			M8	14.7 - 31.4	10.9 - 23.3	
FJT-10-1 10			M10	31.4 - 54.0	23.3 - 40.0	
FJT-10-1 K			M6,8,10	5.4 - 54.0	4.0 - 40.0	
FJT-16-1 12	21.7	47.7	M12	54.0 - 88.2	40.0 - 65.3	
FJT-16-1 14			M14	88.2 - 149	65.3 - 110	
FJT-16-1 16			M16	149 - 190	110 - 141	
FJT-16-1 K			M12,14,16	54 - 190	40 - 141	

MODEL	Part Number		
	AC100V (FJT-xx-1 x)	AC220V (FJT-xxB-1 x)	AC240V (FJT-xxC-1 x)
FJT-5-1 4	541 207 1687	541 205 2990	541 205 2993
FJT-5-1 5	541 207 1688	541 205 2991	541 205 2994
FJT-5-1 K	541 207 1686	541 205 2989	541 205 2992
FJT-10-1 6		541 205 2966	541 205 2970
FJT-10-1 8	541 207 1643	541 205 2967	541 205 2971
FJT-10-1 10		541 205 2968	541 205 2972
FJT-10-1 K	541 207 1644	541 205 2969	541 205 2973
FJT-16-1 12	541 207 1661	541 205 2978	541 205 2982
FJT-16-1 14	541 207 1662	541 205 2979	541 205 2983
FJT-16-1 16	541 207 1663	541 205 2980	541 205 2984
FJT-16-1 K	541 207 1664	541 205 2981	541 205 2985

DIGITAL TORQUE TESTER (NOT AVAILABLE FOR CE)

FDT-2-1 is the ideal Digital Torque Tester for initial setting, periodical torque checking and adjustment of pulse wrenches, angle nutrunners, and hand torque wrenches. Equipped with interfaces and terminals, the FDT-2-1 can communicate with personal computers, printers, data recorders and other peripheral instruments

The Fuji FDT-2-1 is ideal technical assistant in your laboratory and tool-control facility.



FDT-2-1

TT-20
TT-50
TT-150

TT-300

TT-500
TT-1000



Features

- High accuracy within more or less 0.5 per cent of full scale
- Wide measuring range up to 9 900 N.m, 1 000 kgf.m, 7 230 ft.lb
- Bright LED Display for quick and accurate reading
- Built-in Blow Counter for easy blow number adjustment
- 3 measuring units : N.m, kgf.m and ft.lb can be selected
- Easy Calibration check for circuitry function check of the transducer
- RS232C port is available for communication with PC
- 2 types of printer port (Bit parallel and Centronics)are equipped.
- 2 types of Auto Pulse Analysis are equipped.
AVL Average torque
PEAK Peak torque

DIGITAL TORQUE TESTER

MODEL	Part Number	Dimensions						Weight		Power Sources	Power Consumption
		Width		Height		Depth		kg	lb		
		mm	in	mm	in	mm	in			V	W
FDT-2-1	541 205 2586	258	10.156	116	4.57	243	9.58	3.7	8.16	AC100-240	12

ACCESSORIES (DIGITAL TORQUE TESTER)

SOCKET



AC Number	Part Number	Size	FOR MODEL
		in x in	
1333	541 205 9504	F3/8 x M1/2	TT-150

HEX DRIVER BIT



AC Number	Part Number	Size	FOR MODEL
		in x in	
Y-004558-01	541 205 8769	1/2 x 6.35	TT-150
Y-003558-01	541 205 8766	3/8 x 6.35	TT-20, 50

TORQUE TRANSDUCERS (NOT AVAILABLE FOR CE)

MODEL	Part Number	Measuring Range		Square Size		Applicable models
		N.M	ft.lb	mm	in	
TT-20	541 205 6519	2.0 - 20.0	1.4 - 14.7	9.5	3/8	FPW-110, 110S FPW-110SD, FL-4SD use with driver adapter, 541 205 8766
TT-50	541 205 6521	5.0 - 50.0	3.7 - 36.9	9.5	3/8	FL-4-5, FL-4S-6S, FPW-330S FL-4SD-6SD use with driver adapter, 541 205 8766
TT-150	541 205 6518	10 - 150.0	7.4 - 110	9.5	3/8	FPW-770, 770S use with adapter 3/8 SQ, 1333
				12.7	1/2	FPW-770SD, FL-6SD use with driver adapter, 541 205 8769 FL-9-1
TT-300	541 205 6520	20.0 - 300.0	14.7 - 221	12.7	1/2	FL-11-13
TT-500	541 205 6522	200.0 - 500.0	147 - 369	19.0	3/4	FPW-1660-1
TT-1000	541 205 6517	400 - 1000	295 - 738	25.4	1	Large tools in torque range up to 1000 N.m

PORTABLE DIGITAL TACHOMETER (NOT AVAILABLE FOR CE)

The Fuji digital tachometer is ideal for the strict quality control of rotary tools. Accurate rotational speed tests are measured easily by utilising magnetism allowing the sensor to determine the rotational speed.



MB-B (PN 541 207 4543)
Magnet Base

Features

- Bright LED digital indication eliminates operator's errors.
- Non-contact measuring for safe and easy measurement.
- Wide measuring range.
- Quick response for quick measurement.

MODEL	Part Number	Dimensions						Weight		Measuring Range	Response	Measuring Method	Indication	Power Sources	
		Width		Height		Depth		kg	lb					V	Hz
		mm	in	mm	in	mm	in			min-1	seconds				
FDM-202	541 205 2585	150	5.901	60	2.36	212	8.35	1.1	2.43	10 - 999900	6	Non-Contact Type Magnetic Sensor	LED	AC100 - 240	50/60

HOW TO MAGNETIZE

Magnetic Induction method is used for this tachometer. Be sure to magnetize the revolving part of a tool with the magnet provided so that a pair of N and S poles may be made.

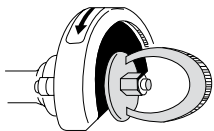

When magnetizing a flat part, be sure to magnetize so that N and S poles may be made at the same time.

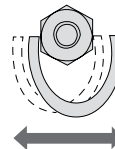
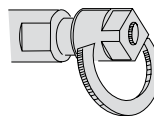

When magnetizing a hexagonal part, a square part, a round part, etc., be sure to magnetize so that N and S poles may be made proportionally.

HOW TO MEASURE

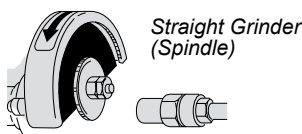

Straight Grinder (Spindle)

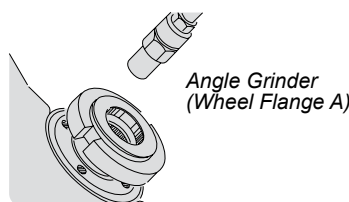

Angle Grinder (Wheel Flange A)

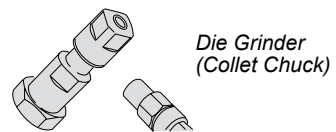

Die Grinder (Collet Chuck)

OIL FILLER - TESTERS

OIL FILLER

The Fuji oil filler is the ideal, and indispensable, equipment required for maintenance and repair of pulse wrenches. By connecting a conventional air supply to the handle valve, the oil filler makes re-filling the pulse unit assembly quick and easy.



FVT-1

Standard model
FVT-1 PN 541 205 3531

CE certified model
FVT-1 EC PN 541 207 2364

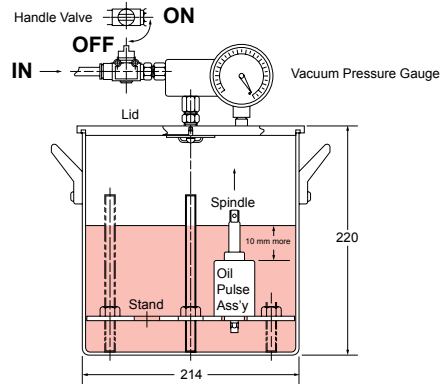

COUNTDOWN ADAPTER

The Fuji FFA-2-2 Countdown Adapter counts the number of bolts tightened. It is used together with FLT & FPT Shut-off Pulse Wrenches (CD type) and FL & FPW Pulse Wrenches and lifts the error proofing capabilities of these tools. Optional devices like Buzzer or Light tower can be connected for quick notice of countdown error, or a signal can be output to the line control system. With its compact size, the FFA-2-2 is easily integrated into the assembly station.



COUNTDOWN ADAPTER

Model	Part Number	Dimensions						Weight		Power Sources	Power Consumption
		Width		Height		Depth		kg	lb		
		mm	in	mm	in	mm	in			V	W
FFA-2-2	541 205 2678	125	4 59/64	62	2 29/64	25	63/64	0.3	0.7	DC24	3

COUPLING WITH HOSE CONNECTION

Model	Type	Part Number
M-C4P02M	Coupling with hose connection for FFA (1/4PT)	541 210 4394
M-C4P03M	Coupling with hose connection for FFA (3/8PT)	541 210 4395
M-C4P04M	Coupling with hose connection for FFA (1/2PT)	541 210 4396

TORQUE CONTROL SYSTEM

To accommodate the various requirements of torque control and assembly application, Fuji offers a complete range of fastening tools and reliable torque controllers designed to enhance quality and increase productivity. The following table shows various combinations of fastening tools and controllers. Choose the correct combination to meet your production requirements.

TOOLS		FW FOW FRW	FL FPW	FLT FPT	FET	FW	FL FPW	FLT FPT	FET
CONTROLLER		-	-	-	FET-100	-	-	-	FET-100
COUNTDOWN ADAPTERS		-	-	-	-	FFA	FFA	FFA	FFA
TORQUE ADJUSTMENT				X	X			X	X
SHUT-OFF				M	T	TI	TI	M	T
DISPLAY	FASTENING OK/NOK				X	X	X	X	X
	TORQUE VALUE				X				X
INPUT/OUTPUT	OK/NOK				X	X	X	X	X
	LINE INTEGRATION				X	X	X	X	X
	NOK REASON				X				X
ERROR PROOFING	BOLT COUNTING				X	X	X	X	X
	TIME LIMITS				X	X	X	X	X
	PULSE COUNTING				X				X
	TORQUE JUDGEMENT				X				X
DATA MEMORY					X				X
DATA OUTPUT	RS232				X				X
	ETHERNET				X				X

M - Mechanical shut-off - Torque Transducer based shut-off - TI Time based shut off

FET Series

CONTROLLING DYNAMIC TORQUE BY OIL PRESSURE

The Fuji FET system wrench is equipped with a torque transducer which enables torque control and monitoring on critical applications.

MINIMIZE TIGHTENING TORQUE SCATTER

Installed tightening torque tends to scatter for soft joint applications due to relaxation issues. To combat this, the FET system has functionality to add additional pulses after reaching torque target which ensures a more stable output.

FET-6-1 TOOL



TAKE THE SIGNAL FROM TRANSDUCER BUILT IN TOOL

SHUT OFF THE TOOL

CONVERT SIGNAL TO TORQUE VALUE

FET-100-1 CONTROLLER



TORQUE CONTROL

BATCH COUNTING

FET SERIES

FET-200-1 COMMANDER



GLOBAL SPECIFICATIONS

Model	Recommended Torque Range		Type	Free Speed min-1	Square Drive Size / Bit Shank Size		Overall Length (without socket)		Weight (without socket)		Air Consumption (at Load)		Air Hose Size	
	N.m	ft.lb			mm	in	mm	in	kg	lb	m ³ /min	ft ³ /min	mm	in
FET-4D-1	5 - 12	3.7 - 8.9	Pistol	6,700	Hex 6.35	Hex 1/4	161.5	6.36	0.96	2.12	0.36	12.7	6.3	1/4
FET-5D-1	11 - 22	8.1 - 16.2	Pistol	6,300	Hex 6.35	Hex 1/4	162	6.38	0.96	2.12	0.4	14.1	6.3	1/4
FET-6D-1	19 - 28	14.0 - 20.7	Pistol	6,700	Hex 6.35	Hex 1/4	174	6.85	1	2.2	0.4	14.1	9.5	3/8
FET-4-1	5 - 12	3.7 - 8.9	Pistol	6,700	Sq 9.5	Sq 3/8	161.5	6.36	0.96	2.12	0.36	12.7	6.3	1/4
FET-5-1	11 - 24	8.1 - 17.7	Pistol	6,300	Sq 9.5	Sq 3/8	162	6.38	0.96	2.12	0.4	14.1	6.3	1/4
FET-6-1	22 - 35	16.2 - 25.8	Pistol	6,700	Sq 9.5	Sq 3/8	174	6.85	1	2.2	0.4	14.1	9.5	3/8
FET-7-1	30 - 60	22.1 - 44.3	Pistol	6,100	Sq 9.5	Sq 3/8	177	6.97	1.2	2.65	0.6	21.2	9.5	3/8
FET-9-1	50 - 85	36.9 - 62.7	Pistol	4,600	Sq 12.7	Sq 1/2	195	7.68	1.6	3.53	0.85	23	9.5	3/8
FET-11-1	70 - 130	51.6 - 95.9	Pistol	5,000	Sq 12.7	Sq 1/2	206.5	8.13	2	4.41	0.8	28.2	9.5	3/8
FET-13-1	90 - 160	66.4 - 118.0	Pistol	3,800	Sq 12.7	Sq 1/2	216.5	8.52	2.3	5.07	0.85	30.1	9.5	3/8
FET-16-1	150 - 210	110.6 - 154.9	Pistol	3,000	Sq 19.0	Sq 3/4	262	10.3	4.4	9.7	1.2	42.4	9.5	3/8

FET SERIES SYSTEM

TOOL SELECTION GUIDE

Standard models

Model	Square Drive Retainer		Driver bit type
	P	BF	
FET-4D-1			541 210 2871
FET-5D-1			541 210 2872
FET-6D-1			541 210 2873
FET-4-1	541 207 1365	541 207 1366	
FET-5-1	541 207 1372	541 207 1373	
FET-6-1	541 207 1376	541 207 1377	
FET-7-1	541 207 1381	541 207 1382	
FET-9-1	541 207 1387	541 207 1388	
FET-11-1	541 207 1345	541 207 1346	
FET-13-1	541 207 1350	541 207 1351	
FET-16-1	541 207 1355		

UNIQUE FEATURES OF FET SERIES

- **Tightening graph display.**
(Possible to check pulses, torque and tightening time visually.)
- **Monitor tightening by torque value, time and pulses.**
(Improve detection of tightening error)

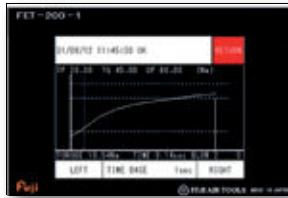

- **Bolts and blows counting function.**
Clarify the maintenance time by setting warning by bolts or pulses.

- **Channel.**
1 controller has 7 channels for flexible application.

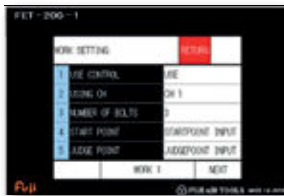

- **Small footprint.**

- **Strong Cables.**
Kevlar reinforced cables ensure durability in tough operation



FET-4D-1

FET-16-1

FET SERIES KIT

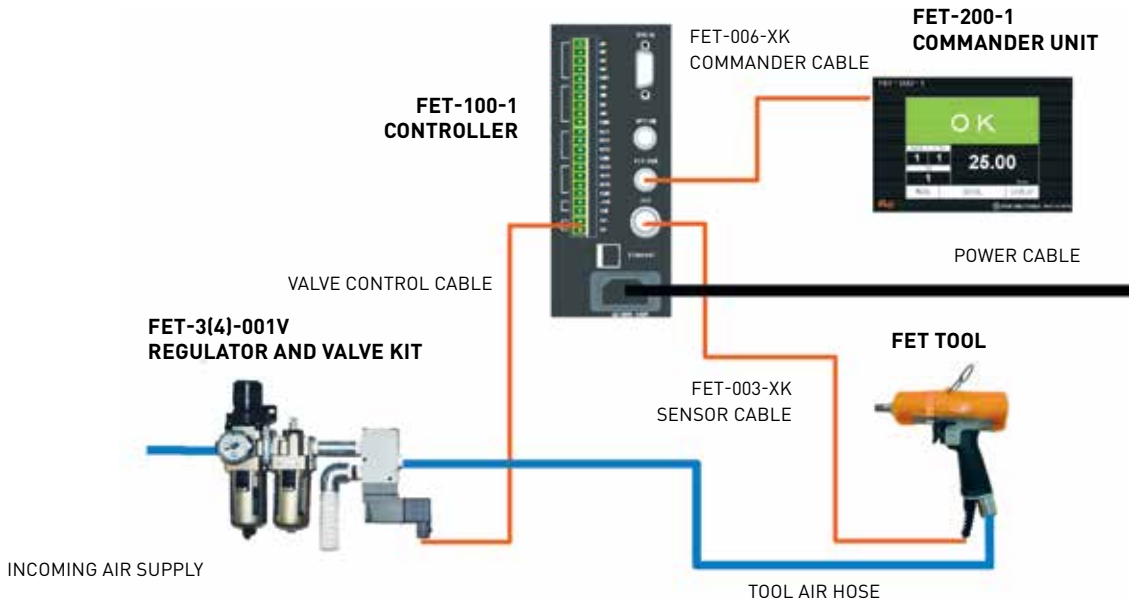

ACCESSORIES

The FET Kits collect all necessary accessories for ease of ordering. Kits are grouped based on tool size and hose type. Note that tool is purchased separately.

FOR FET 4, 5, 6, 7

Model	Type	Part Number
FET-K-ST3	Straight hose, 3m	541 210 4083
FET-K-ST6	Straight hose, 6m	541 210 4084
FET-K-S	Twin coil hose, 3m	541 210 4085

FOR FET 9, 11, 13

Model	Type	Part Number
FET-K-LT3	Straight hose, 3m	541 210 4086
FET-K-LT6	Straight hose, 6m	541 210 4087
FET-K-L	Twin coil hose, 3m	541 210 4088

CABLES

Part Number	Description	Length (m)
541 207 1324	FET-003-3K SENSOR CABLE	3
541 210 4076	FET-003-6K SENSOR CABLE	6
541 210 3283	FET-003-10K SENSOR CABLE	10
541 210 4077	FET-003-3X EXTENSION CABLE	1
541 207 1325	FET-003-5X EXTENSION CABLE	3
541 210 4044	FET-006-1.5K COMMANDER CABLE	1.5
541 207 1335	FET-006-3K COMMANDER CABLE	3
541 210 4078	FET-003-8-3S STRAIGHT HOSE	3
541 210 4079	FET-003-8-6S STRAIGHT HOSE	6
541 210 4081	FET-003-11-3S STRAIGHT HOSE	3
541 210 4082	FET-003-11-6S STRAIGHT HOSE	6
541 207 1327	FET-003-8T TWIN COIL HOSE	3
541 207 1321	FET-003-11T TWIN COIL HOSE	3

INTERFACE ACCESSORIES

Part Number	Description
541 207 1344	FET-100-1 CONTROLLER
541 207 1356	FET-200-1 COMMANDER UNIT
541 207 1359	FET-3-001V SOLENOID VALVE
541 207 1363	FET-4-001V SOLENOID VALVE
541 207 4555	M-P02S 1/4 NON-ROTATIONAL COUPLER

KIT CONTENT

ALL KITS



Controller (1pc)
FET-100-1
(541 207 1344)



Commander (1pc)
FET-200-1
(541 207 1356)



Coupler 1 pc
1/4 Non-rotational Coupler
(541 207 4555)



Commander Cable (3m) (1pc)
Controller - Commander
FET-006-3K (541 207 1335)

Solenoid Valve, FRL Kit (1set)

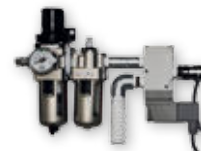

FET-3-001V (541 207 1359)
FET-4-001V (541 207 1363)

FET-K-LT6 - FET-K-ST3 KITS



Sensor Cable (3m) (1pc)
Tool - Controller
FET-003-3K (FOR FET-K-ST3, FET-LT3)
FET-003-6K (FOR FET-K-ST6, FET-LT6)

FET-K-LT6 - FET-K-ST3 KITS



Straight Hose (1set)
FET-003-8-3S 8mm ID x 3m (FOR FET-K-ST3)
FET-003-8-6S 8mm ID x 6m (FOR FET-K-ST6)
FET-003-11-3S 11mm ID x 3m (FOR FET-K-LT3)
FET-003-11-6S 11mm ID x 6m (FOR FET-K-ST6)

FET-K-S - FET-K-L KITS



Twin Coil Hose and interface sensor cable(1set)
FET-003-8T 8mm ID x 3m (FOR FET-K-S)
FET-003-11T 11mm ID x 3m (FOR FET-K-L)

PULSE WRENCHES NON SHUT-OFF TYPE

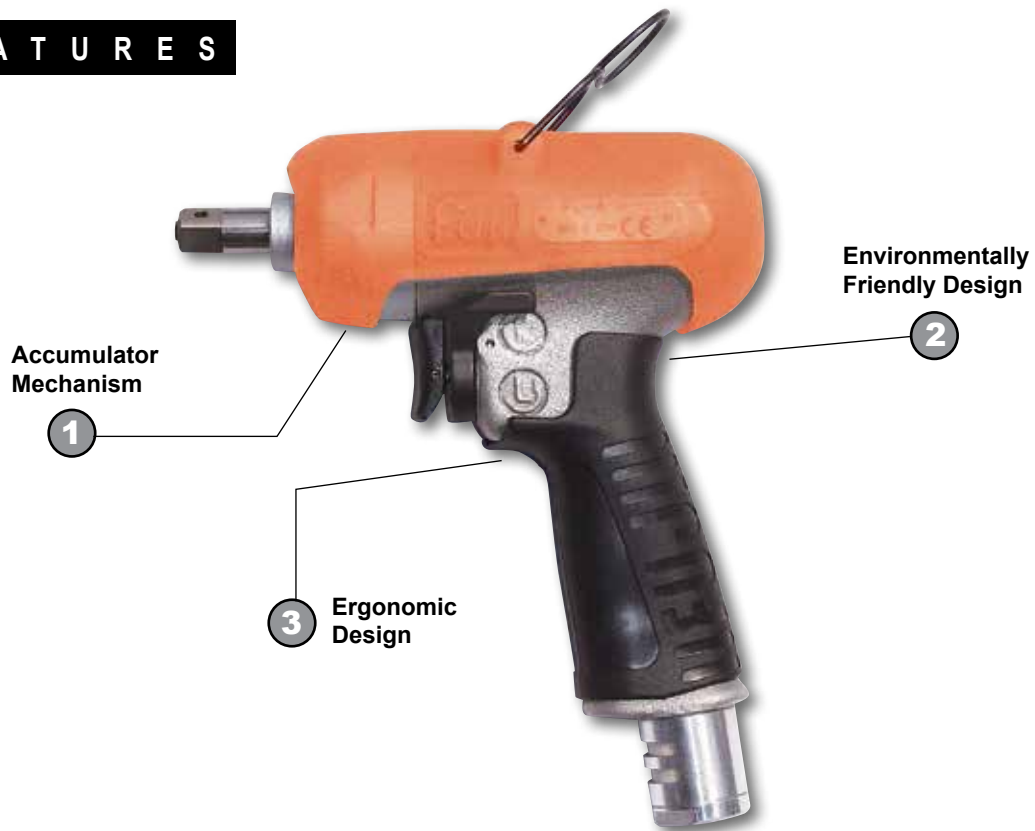
FL Series**F E A T U R E S****1 ACCUMULATOR MECHANISM**

The accumulator functions to compensate against the sudden rise of oil pressure when tightening a hard joint. Torque scatter and error is minimised.

As the oil temperature increases during consecutive tightening, the accumulator takes in the expanded volume of oil to maintain a consistent oil volume in the pulse unit. This ensures high tightening torque accuracy.

2 ENVIRONMENTALLY FRIENDLY DESIGN

To reduce effects on the environment and environmental energy during the life cycle of the tool, no paints is applied to the body of the tool. Consequently, the effect of paint peeling is eliminated. The fully cover protector is designed as standard.

3 ERGONOMIC DESIGN

Compared with conventional tools, weight is kept to a minimum. The grip handle size is optimised to provide enhanced levels of operator comfort. This special grip also absorbs vibration more effectively.

Furthermore, reduced noise and vibration levels are standard with the FL series due to the optimised dimensions.



PULSE WRENCHES NON SHUT-OFF TYPE

Recommended Torque Range, Max Torque

Shows recommended torque range or max torque of the model. Torque figures in the specifications must be used as guidance only, as final output depends on type and size of bolts and nuts, joint rate and air pressure etc.

PISTOL AND STRAIGHT MODELS (SQUARE DRIVE - BIT SHANK) Sq. 6.35 mm (1/4") ~ 9.5 mm (3/8") ~ 12.7 mm (1/2")



GLOBAL SPECIFICATIONS

Model	Recommended Torque Range		Type	Free Speed		Square Drive Size / Bit Shank Size		Overall Length (without socket)		Weight (without socket)		Air Consumption (at Load)		Air Hose Size	
	N.m	ft.lb		min-1	mm	in	mm	in	kg	lb	m³/min	ft³/min	mm	in	
FL-4SD-1	6 - 14	4.4 - 10.3	Straight	5,600	Hex 6.35	Hex 1/4	210	8.27	0.85	1.87	0.4	12.7	6.3	1/4	
FL-4D-1	14 - 20	10.3 - 14.8	Pistol	6,700	Hex 6.35	Hex 1/4	140	5.51	0.79	1.74	0.4	12.7	6.3	1/4	
FL-5SD-1	11 - 24	8.1 - 17.7	Straight	6,300	Hex 6.35	Hex 1/4	210	8.27	0.85	1.87	0.4	14.1	6.3	1/4	
FL-5D-1	18 - 32	13.3 - 23.6	Pistol	6,300	Hex 6.35	Hex 1/4	140	5.51	0.79	1.74	0.4	14.2	6.3	1/4	
FL-6SD-1	21 - 32	15.5 - 23.6	Straight	5,600	Hex 6.35	Hex 1/4	221	8.7	0.9	1.99	0.4	14.8	9.5	3/8	
FL-6D-1	25 - 42	18.4 - 31.0	Pistol	6,700	Hex 6.35	Hex 1/4	152	5.98	0.83	1.83	0.4	14.8	9.5	3/8	
FL-4S-1	6 - 14	4.4 - 10.3	Straight	5,600	Sq 9.5	Sq 3/8	209	8.23	0.85	1.88	0.4	12.7	6.3	1/4	
FL-4-1	16 - 24	11.8 - 17.7	Pistol	6,700	Sq 9.5	Sq 3/8	139.5	5.49	0.79	1.74	0.4	12.7	6.3	1/4	
FL-5S-1	11 - 24	8.1 - 17.7	Straight	6,300	Sq 9.5	Sq 3/8	209	8.23	0.85	1.88	0.4	14.1	6.3	1/4	
FL-5-1	20 - 40	14.8 - 29.5	Pistol	6,300	Sq 9.5	Sq 3/8	139.5	5.49	0.79	1.74	0.4	14.1	6.3	1/4	
FL-6S-1	21 - 32	15.5 - 23.6	Straight	5,600	Sq 9.5	Sq 3/8	221	8.7	0.9	1.99	0.4	14.8	9.5	3/8	
FL-6-1	28 - 56	20.7 - 41.3	Pistol	6,700	Sq 9.5	Sq 3/8	151.5	5.96	0.83	1.83	0.4	14.8	9.5	3/8	
FL-7-1	34 - 60	25.1 - 44.3	Pistol	6,100	Sq 9.5	Sq 3/8	155	6.1	1.02	2.25	0.6	21.2	9.5	3/8	
FL-9-1	52 - 96	38.4 - 70.8	Pistol	5,000	Sq 12.7	Sq 1/2	173	6.81	1.45	3.2	0.7	23.0	9.5	3/8	
FL-11-1	80 - 136	59.0 - 100	Pistol	5,000	Sq 12.7	Sq 1/2	184	7.24	1.8	3.97	0.8	28.3	9.5	3/8	
FL-13-1	120 - 172	88.5 - 127	Pistol	3,800	Sq 12.7	Sq 1/2	192	7.56	2.1	4.63	0.9	30.0	9.5	3/8	

TOOL SELECTION GUIDE

Standard models

Model	Bolt Size	Square Drive Retainer		Driver Bit Size	
		P (Hole)	BF (Pin)	Short (-1)	Long (-10)
FL-4SD	M5 - M6			541 210 2853	541 210 2854
FL-4D	M6 - M8			541 205 2998	541 205 2999
FL-5SD	M6 - M8			541 210 2855	541 210 2856
FL-5D	M8			541 205 3001	541 205 3002
FL-6SD	M8			541 210 2857	541 210 2858
FL-6D	M8 - M10			541 205 3004	541 205 3005
FL-4S-1	M5 - M6	541 207 1720	541 207 1721		
FL-4-1	M6 - M8	541 207 1712	541 205 2997		
FL-5S-1	M6 - M8	541 207 1731	541 207 1732		
FL-5-1	M8	541 207 1722	541 205 3000		
FL-6S-1	M8	541 207 1743	541 207 1744		
FL-6-1	M8 - M10	541 207 1733	541 205 3003		
FL-7-1	M8 - M10	541 207 1745	541 205 3006		
FL-9-1	M10 - M12	541 207 1749	541 205 3007		
FL-11-1	M12 - M14	541 207 1701	541 205 2995		
FL-13-1	M12 - M14	541 207 1705	541 205 2996		

CE certified models

Model	Bolt Size	Square Drive Retainer		Driver Bit Size	
		P (Hole)	BF (Pin)	Short (-1)	Long (-10)
FL-4SD	M5 - M6			541 210 3002	541 210 3003
FL-4D-1	M6 - M8			541 207 1718	
FL-5SD	M6 - M8			541 210 3004	541 210 3005
FL-5D	M8			541 207 1728	541 207 1730
FL-6SD	M8			541 210 3006	541 210 3007
FL-6D-1	M8 - M10			541 207 1739	
FL-4-1	M6 - M8		541 207 1715		
FL-5-1	M8		541 207 1725		
FL-5S-1	M6 - M8	541 210 4715			
FL-6-1	M8 - M10		541 207 1736		
FL-7-1	M8 - M10		541 207 1748		
FL-9-1	M10 - M12		541 207 1752		
FL-11-1	M12 - M14		541 207 1704		
FL-13-1	M12 - M14		541 207 1708		

For CE region availability of non CE models, please inquire to your Fuji representative.

NPT models

Model	Bolt Size	Square Drive Retainer		Driver Bit Size	
		P (Hole)	BF (Pin)	Short (-1)	Long (-10)
FL-4D	M6 - M8			541 205 8931	541 205 8932
FL-5D	M8			541 205 8934	541 205 8935
FL-6D	M8 - M10			541 205 8937	541 205 8938
FL-4-1	M6 - M8		541 205 8930		
FL-5-1	M8		541 205 8933		
FL-6-1	M8 - M10		541 205 8936		
FL-7-1	M8 - M10		541 205 8939		
FL-9-1	M10 - M12		541 207 1750		
FL-11-1	M12 - M14		541 205 8928		
FL-13-1	M12 - M14		541 205 8929		

For possibility of NPT inlet for other models, please inquire to your Fuji representative.

SQUARE DRIVE ANVIL

P BF

BIT SIZE

FL-***SD-1, FL-***D-1
A:9.5mm B:12mm

FL-***SD-10, FL-***D-10
A:13mm B:16mm

PULSE WRENCHES NON SHUT-OFF TYPE

PISTOL GRIP & STRAIGHT MODELS (SQUARE DRIVE - BIT SHANK)



FPW-110SD



FPW-110-1



FPW-1660-1



FPW-2220S-1

GLOBAL SPECIFICATIONS

Model	Recommended Torque Range		Type	Free Speed	Square Drive Size / Bit Shank Size		Overall Length (without socket)		Weight (without socket)		Air Consumption (at Load)		Air Hose Size	
	N.m	ft.lb			min-1	mm	in	mm	in	kg	lb	m ³ /min	ft ³ /min	mm
FPW-110SD-1	2 - 7	1.5 - 5.2	Straight	3,200	Hex 6.35	Hex 1/4	224	8.82	0.65	1.43	0.2	7.1	6.3	1/4
FPW-110D-1	7-11(2-7)	5.2-8.1(1.4-5.1)	Pistol	4,500	Hex 6.35	Hex 1/4	149	5.87	0.76	1.68	0.2	7.1	6.3	1/4
FPW-110S-1	2-7.5	1.5-5.5	Straight	3,200	Sq 9.5	Sq 3/8	218	8.58	0.65	1.43	0.2	7.1	6.3	1/4
FPW-110-1 P	7.5-13(2-7.5)	5.5-9.6(1.4-5.5)	Pistol	4,500	Sq 9.5	Sq 3/8	143	5.63	0.75	1.65	0.2	7.1	6.3	1/4
FPW-770S-1 BL	44 - 76	33 - 56	Straight	6,300	Sq 9.5	Sq 3/8	240	9.4	0.65	1.4	0.5	15.9	12.7	1/2
FPW-770SC-1	33 - 50	24 - 37	Straight	6,300	Sq 9.5	Sq 3/8	255	10.0	0.65	1.4	0.5	15.9	12.7	1/2
FPW-1660-1	160 - 270	118-199	Pistol	3,000	Sq 19.0	Sq 3/4	243	9.57	3.8	8.4	1.2	42.4	9.5	3/8
FPW-2220S-1	300 - 500	221-369	Straight	2,500	Sq 19.0	Sq 3/4	350	13.8	7	15.4	1.3	45.9	12.7	1/2

TOOL SELECTION GUIDE

Standard models

Model	Bolt Size	Square Drive Retainer		Driver Bit Size	
	mm	P	BF	Short (-1)	Long (-10)
FPW-110SD	M5			541 205 3171	541 205 3172
FPW-110D	M4 - M6			541 205 3164	541 205 3166
FPW-770S-1		541 207 2100	541 205 3209		
FPW-770SC-1		541 207 2102	541 205 3211		
FPW-110-1	M4 - M6	541 207 2074	541 205 3162		
FPW-1660-1	M14 - M16	541 205 3174			
FPW-2220S-1	M16 - M20	541 205 3176			

CE certified models

Model	Bolt Size	Square Drive Retainer		Driver Bit Size	
	mm	P	BF	Short (-1)	Long (-10)
FPW-110D	M4 - M6			541 207 2076	
FPW-770SC-1			541 207 2103		
FPW-110S-1	M4 - M5	541 207 2078			
FPW-110-1	M4 - M6		541 207 2075		
FPW-1660-1	M14 - M16	541 207 2081			
FPW-2220S-1	M16 - M20	541 207 2083			

For CE region availability of non CE models, please inquire to your Fuji representative.

NPT models

Model	Bolt Size	Square Drive Retainer		Driver Bit Size	
	mm	P	BF	Short (-1)	Long (-10)
FPW-110SD	M5			541 205 3170	
FPW-110D	M4 - M6			541 205 3165	
FPW-770S-1			541 205 3210		
FPW-1660-1	M14 - M16	541 205 3175			
FPW-2220S-1	M16 - M20	541 207 2082			

For possibility of NPT inlet for other models, please inquire to your Fuji representative.

SQUARE DRIVE ANVIL

P

BF

BIT SIZE

FPW-***SD-1, FPW-***D-1
A:9.5mm B:12mm

FPW-***SD-10, FPW-***D-10
A:13mm B:16mm

PULSE WRENCHES SHUT-OFF TYPE

FLT Series**FEATURES****1 SHUT-OFF VALVE MECHANISM**

The Fuji shut-off valve and piston design provides the benefit of stable shut-off and torque levels. The design ensures smooth movement of the piston which means oil pressure is transmitted precisely to the shut-off valve. In effect - both the accuracy and consistency of the tightening torque is improved greatly. For the low air pressure operation 0.4-0.5 MPa (4-5 bar), low pressure models (-L) are provided with special design optimizing oil flow from relief valve. Thanks to this design, even low oil pressure can be transmitted exactly to the shut-off valve.

2 PLUNGER MECHANISM

Plunger Mechanism provides the benefit of improved Torque Accuracy.

For control of low torque, the oil pressure applied to the piston is maintained at a low level and improves torque control. To ensure high accuracy control of low torque, the plunger mechanism is utilised to deliver torque accurately. Oil leakage is prevented within the mechanism via a passage in the plunger which is designed to accommodate changes in oil pressure when the pulse is generated. Consequently, torque and tightening accuracy stability are maintained.

3 ACCUMULATOR MECHANISM

The Accumulator functions to compensate against the sudden rise of oil pressure when tightening a hard joint. Torque scatter and error is minimised.

As the oil temperature increases during consecutive tightening, the accumulator takes in the expanded volume of oil to maintain a consistent oil volume in the pulse unit. This ensures high tightening torque accuracy.

4 ENVIRONMENT FRIENDLY DESIGN

To reduce effects on the environment and environmental energy during the life cycle of the tool, no paint is applied to the body of the tool. Consequently, the effect of paint peeling is eliminated. The full cover protector is designed as standard.

5 ERGONOMIC DESIGN

Compared with conventional tools, weight is kept to a minimum. The grip handle size is optimised to provide enhanced levels of operator comfort. This special grip also absorbs vibration more effectively. Furthermore, reduced noise and vibration levels are standard with the FLT series due to the optimised dimensions.



PULSE WRENCHES SHUT-OFF TYPE

STANDARD MODELS (SQUARE DRIVE - BIT SHANK)

Sq. 9.5 mm (3/8") ~ 19 mm (3/4") - Hex. 6.35 (1/4")



FLT-4-2



FLT-9-2



FLT-4D-2



FLT-4S-1



FLT-20S-1

CD reporting type is available for the operations which require bolt counting. Together with the FFA-2-2 countdown adapter, error proofing capabilities are possible

FLT-9 CD type and FFA-2-2



GLOBAL SPECIFICATIONS

Model	Recommended Torque Range		Type	Free Speed	Square Drive Size / Bit Shank Size		Overall Length (without socket)		Weight (without socket)		Air Consumption (at Load)			Air Hose Size	
	N.m	ft.lb			mm	in	mm	in	kg	lb	m ³ /min	ft ³ /min	mm	in	
FLT-4SD	5.5 - 11	4.1 - 8.1	Straight	5,500	Hex 6.35	Hex 1/4	221.5	8.72	0.88	1.94	0.35	12.4	6.3	1/4	
FLT-4D	5 - 12	3.7 - 8.9	Pistol	6,200	Hex 6.35	Hex 1/4	181	7.13	0.97	2.14	0.4	14.1	6.3	1/4	
FLT-5SD	11 - 20	8.1 - 14.8	Straight	6,400	Hex 6.35	Hex 1/4	221.5	8.72	0.88	1.94	0.36	12.7	6.3	1/4	
FLT-5D	11 - 22	8.1 - 16.2	Pistol	6,500	Hex 6.35	Hex 1/4	181	7.13	0.97	2.14	0.45	15.9	6.3	1/4	
FLT-6SD	21 - 30	15.5 - 22.1	Straight	5,800	Hex 6.35	Hex 1/4	234	9.21	0.95	2.1	0.42	14.8	9.5	3/8	
FLT-6D	19 - 28	14.0 - 20.7	Pistol	6,300	Hex 6.35	Hex 1/4	193	7.6	1	2.21	0.55	19.4	9.5	3/8	
FLT-4S-1	5.5 - 11	4.1 - 8.1	Straight	4,300	Sq 9.5	Sq 3/8	222	8.74	0.88	1.94	0.33	11.7	6.3	1/4	
FLT-4-2	5 - 12	3.7 - 8.9	Pistol	6,200	Sq 9.5	Sq 3/8	180.5	7.11	0.97	2.14	0.4	14.1	6.3	1/4	
FLT-5S-1	11 - 20	8.1 - 14.8	Straight	6,400	Sq 9.5	Sq 3/8	222	8.74	0.88	1.94	0.36	12.7	6.3	1/4	
FLT-5-2	11 - 24	8.1 - 17.7	Pistol	6,500	Sq 9.5	Sq 3/8	180.5	7.11	0.97	2.14	0.45	15.9	6.3	1/4	
FLT-6S-1	21 - 30	15.5 - 22.1	Straight	5,800	Sq 9.5	Sq 3/8	234	9.21	0.95	2.1	0.42	14.8	9.5	3/8	
FLT-6-2	22 - 35	16.2 - 25.8	Pistol	6,300	Sq 9.5	Sq 3/8	192.5	7.58	1	2.21	0.55	19.4	9.5	3/8	
FLT-7-2	30 - 50	22.1 - 37.0	Pistol	6,100	Sq 9.5	Sq 3/8	189.5	7.46	1.1	2.43	0.6	21.2	9.5	3/8	
FLT-9-2	45 - 85	33.2 - 63.0	Pistol	5,300	Sq 12.7	Sq 1/2	209	8.23	1.6	3.53	0.68	24.0	9.5	3/8	
FLT-11-2	70 - 120	51.6 - 88.9	Pistol	5,000	Sq 12.7	Sq 1/2	217.5	8.56	1.85	4.08	0.8	28.2	9.5	3/8	
FLT-13-2	110 - 150	81.1 - 111	Pistol	3,400	Sq 12.7	Sq 1/2	227.5	8.96	2.1	4.63	0.85	30.0	9.5	3/8	
FLT-20S-1	200 - 400	148 - 296	Straight	2,500	Sq 19.0	Sq 3/4	405	15.9	8.8	19.4	1.3	45.9	12.7	1/2	

TOOL SELECTION GUIDE

Standard models

Model	Bolt Size	NORMAL TYPE				CD REPORTING TYPE								
		Square Drive Retainer		Driver Bit Size		Square Drive Retainer		Driver Bit Size						
		mm	P (Hole)	BF (Pin)	Short (-1) (-2)	Long (-10) (-20)	P (Hole)	BF (Pin)	Short (-1) (-2)					
FLT-4SD-1	M5 - M6				541 207 1809									
FLT-4SD-10	M5 - M6													
FLT-4D-2	M5 - M6				541 210 3904								541 210 3906	
FLT-5SD-1	M6 - M8				541 207 1834									
FLT-5SD-10	M6 - M8													
FLT-5D-2	M6 - M8				541 210 3916									541 210 3918
FLT-6SD-1	M8				541 207 1860									
FLT-6SD-10	M8													
FLT-6D-2	M8				541 210 3928									541 210 3930
FLT-4S-1	M5 - M6	541 206 0694		541 206 0695										
FLT-4-2	M5 - M6	541 210 3898		541 210 3899				541 210 3901		541 210 3902				
FLT-5S-1	M6 - M8	541 206 0696		541 206 0697										
FLT-5-2	M6 - M8	541 210 3910		541 210 3911				541 210 3913		541 210 3914				
FLT-6S-1	M8	541 206 0698		541 206 0699										
FLT-6-2	M8	541 210 3922		541 210 3923				541 210 3925		541 210 3926				
FLT-7-2	M8 - M10	541 210 3934		541 210 3935				541 210 4262		541 210 3938				
FLT-9-2	M10 - M12	541 210 3940		541 210 3941				541 210 3943		541 210 3944				
FLT-11-2	M10 - M12	541 210 3946		541 210 3947				541 210 3949		541 210 3950				
FLT-13-2	M12 - M14	541 210 3952		541 210 3953				541 210 3955		541 210 3956				
FLT-20S-1	M16 - M20			541 205 3010										

SQUARE DRIVE ANVIL

P BF

BIT SIZE

FLT-***SD-1, FLT-***D-2
A: 9.5mm B: 12mm

FLT-***SD-10, FLT-***D-20
A: 13mm B: 16mm

PULSE WRENCHES SHUT-OFF TYPE

CE certified models

Model	Bolt Size	NORMAL TYPE				CD REPORTING TYPE			
		Square Drive Retainer		Driver Bit Size		Square Drive Retainer		Driver Bit Size	
		mm	P (Hole)	BF (Pin)	Short (-1) (-2)	Long (-10) (-20)	P (Hole)	BF (Pin)	Short (-1) (-2)
FLT-4D-2	M5 - M6				541 210 4011				541 210 4173
FLT-5D-2	M6 - M8				541 210 4018				541 210 4180
FLT-6D-2	M8				541 210 4024				541 210 4186
FLT-4-2	M5 - M6			541 210 4008				541 210 4172	
FLT-7-2	M8 - M10			541 210 4027					
FLT-9-2	M10 - M12			541 210 4030					
FLT-11-2	M10 - M12			541 210 4034					
FLT-20S-1	M16 - M20	541 207 1785							

For CE region availability of non CE models, please inquire to your Fuji representative.

NPT models

Model	Bolt Size	NORMAL TYPE				CD REPORTING TYPE			
		Square Drive Retainer		Driver Bit Size		Square Drive Retainer		Driver Bit Size	
		mm	P (Hole)	BF (Pin)	Short (-1) (-2)	Long (-10) (-20)	P (Hole)	BF (Pin)	Short (-1) (-2)
FLT-4D-2	M5 - M6				541 210 4012				541 210 4174
FLT-4D-20	M5 - M6					541 210 4014			541 210 4176
FLT-5D-2	M6 - M8				541 210 4019				541 210 4181
FLT-5D-20	M6 - M8					541 210 4020			541 210 4183
FLT-6D-2	M8				541 210 4025				541 210 4187
FLT-6D-20	M8					541 210 4026			541 210 4189
FLT-5-2	M6 - M8			541 210 4016					
FLT-6-2	M8			541 210 4022					
FLT-7-2	M8 - M10			541 210 4028					
FLT-11-2	M10 - M12			541 210 4035					
FLT-13-2	M12 - M14			541 210 4061					

For possibility of NPT inlet for other models, please inquire to your Fuji representative.

SQUARE DRIVE ANVIL

P

BF



BIT SIZE

FLT-***SD-1, FLT-***D-2
A:9.5mm B:12mm

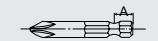

FLT-***SD-10, FLT-***D-20
A:13mm B:16mm

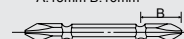

PULSE WRENCHES SHUT-OFF TYPE

For the low air pressure operation 0.4-0.5 MPa (4-5 bar), low pressure models (-L) are provided with special design optimizing oil flow from relief valve. This design enables accurate and consistent tightening.

LOW PRESSURE MODELS



FLT-4-2 L



FLT-9-2L



FLT-4D-2L



FLT-5SD-1L

CD reporting type is available for the operations which require bolt counting. Together with the FFA-2-2 countdown adapter, error proofing capabilities are possible

FLT-9-2L CD type and FFA-2-2



GLOBAL SPECIFICATIONS

Model	Recommended Torque Range		Type	Free Speed	Square Drive Size / Bit Shank Size		Socket Retainer	Overall Length (without socket)		Weight (without socket)		Air Consumption (at Load)		Air Hose Size	
	N.m	ft.lb			min-1	mm		in	mm	in	kg	lb	m ³ /min	ft ³ /min	mm
FLT-4D	4.5 - 8	3.3 - 5.9	Pistol	4,900	Hex 6.35	Hex 1/4	Bit Shank (Hex)	181	7.13	0.97	2.14	0.3	10.6	6.3	1/4
FLT-5D	8 - 16	5.9 - 11.8	Pistol	5,200	Hex 6.35	Hex 1/4	Bit Shank (Hex)	181	7.13	0.97	2.14	0.35	12.4	6.3	1/4
FLT-5SD	10 - 18	7.4 - 13.3	Straight	5,100	Hex 6.35	Hex 1/4	Bit Shank (Hex)	221.5	8.72	0.88	1.94	0.25	8.9	6.3	1/4
FLT-6D	14 - 22	10.3 - 16.2	Pistol	5,700	Hex 6.35	Hex 1/4	Bit Shank (Hex)	193	7.6	1	2.21	0.4	14.2	9.5	3/8
FLT-6SD	19 - 27	14.0 - 19.9	Straight	5,100	Hex 6.35	Hex 1/4	Bit Shank (Hex)	233.5	9.19	0.95	2.1	0.28	10.0	9.5	3/8
FLT-4-2L	4.5 - 10.0	3.3 - 7.4	Pistol	4,900	Sq 9.5	Sq 3/8	Hole (P-Anvil)	180.5	7.11	0.97	2.14	0.3	10.6	6.3	1/4
FLT-5S-1L	10 - 18	7.4 - 13.3	Straight	5,100	Sq 9.5	Sq 3/8	Hole (P-Anvil)	221.5	8.72	0.88	1.94	0.22	7.8	6.3	1/4
FLT-5-2L	10 - 18	7.4 - 13.3	Pistol	5,200	Sq 9.5	Sq 3/8	Hole (P-Anvil)	180.5	7.11	0.97	2.14	0.3	10.6	6.3	1/4
FLT-6S-1L	19 - 27	14.0 - 19.9	Straight	5,100	Sq 9.5	Sq 3/8	Hole (P-Anvil)	221.5	8.72	0.95	2.1	0.22	7.8	9.5	3/8
FLT-6-2L	12 - 26	8.9 - 19.2	Pistol	5,700	Sq 9.5	Sq 3/8	Hole (P-Anvil)	192.5	7.58	1	2.21	0.4	14.2	9.5	3/8
FLT-7-2L	24 - 45	17.7 - 33.2	Pistol	5,400	Sq 9.5	Sq 3/8	Hole (P-Anvil)	189.5	7.46	1.1	2.43	0.5	17.6	9.5	3/8
FLT-9-2L	45 - 75	33.2 - 55.3	Pistol	4,200	Sq 12.7	Sq 1/2	Hole (P-Anvil)	209	8.23	1.6	3.53	0.58	20.6	9.5	3/8
FLT-11-2L	65 - 110	47.9 - 81.1	Pistol	4,100	Sq 12.7	Sq 1/2	Hole (P-Anvil)	217.5	8.56	1.85	4.08	0.65	23.0	9.5	3/8
FLT-13-2L	80 - 125	59.0 - 92.2	Pistol	3,300	Sq 12.7	Sq 1/2	Hole (P-Anvil)	227.5	8.96	2.1	4.63	0.7	24.7	9.5	3/8

TOOL SELECTION GUIDE

Standard models

Model	Bolt Size	NORMAL TYPE				CD REPORTING TYPE			
		Square Drive Retainer		Driver Bit Size		Square Drive Retainer		Driver Bit Size	
		P (Hole)	BF	Short (-1) (-2)	Long (-10) (-20)	P (Hole)	BF	Short (-1) (-2)	Long (-10) (-20)
FLT-4D-20L	M5 - M6				541 210 4215				
FLT-4D-2L	M5 - M6				541 210 4213				541 210 4255
FLT-5D-20L	M5 - M6							541 210 4222	
FLT-5D-2L	M5 - M6				541 210 4220				541 210 4258
FLT-6D-20L	M6 - M8							541 210 4229	
FLT-6D-2L	M6 - M8				541 210 4227				541 210 4261
FLT-4-2L	M5 - M6	541 210 4210	541 210 4211			541 210 4253	541 210 4254		
FLT-5-2	M6 - M8	541 210 4217	541 210 4218			541 210 3913	541 210 4257		
FLT-6-2L	M6 - M8	541 210 4224	541 210 4225			541 210 4259	541 210 4260		
FLT-7-2L	M8 - M10	541 210 4231	541 210 4232			541 210 4262	541 210 4263		
FLT-9-2L	M10 - M12	541 210 4234	541 210 4235			541 210 4264	541 210 4265		
FLT-11-2L	M10 - M12	541 210 4237	541 210 4238			541 210 4266	541 210 4267		
FLT-13-2L	M12 - M14	541 210 4240	541 210 4241			541 210 4268	541 210 4269		

For CE region availability of non CE models, please inquire to your Fuji representative. For possibility of NPT inlet for other models, please inquire to your Fuji representative.

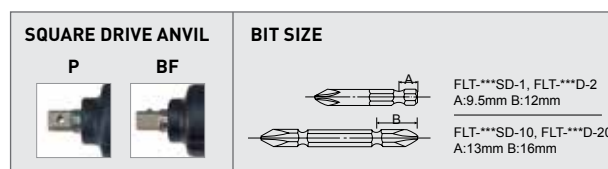

PULSE WRENCHES SHUT-OFF TYPE

PISTOL GRIP & STRAIGHT MODELS (SQUARE DRIVE - BIT SHANK) Hex. 6.35 mm (1/4") ~ Sq. 9.5 mm (3/8") ~ 19 mm (3/4")



FPT-110SD-1



FPT-110S-1



FPT-770S



FPT-1660-1

GLOBAL SPECIFICATIONS

Model	Recommended Torque Range		Type	Free Speed		Square Drive Size / Bit Shank Size		Overall Length (without socket)		Weight (without socket)		Air Consumption (at Load)		Air Hose Size	
	N.m	ft.lb		min-1	mm	in	mm	in	kg	lb	m ³ /min	ft ³ /min	mm	in	
FPT-110D	2 - 5	1.5 - 3.7	Pistol	6,000	Hex 6.35	Hex 1/4	194.5	7.66	0.95	2.09	0.2	7.1	6.3	1/4	
FPT-110SD	3 - 6	2.2 - 4.4	Straight	4,700	Hex 6.35	Hex 1/4	239.5	9.43	0.7	1.54	0.2	7.1	6.3	1/4	
FPT-110-1	2 - 5	1.5 - 3.7	Pistol	6,000	Sq 9.5	Sq 3/8	194.5	7.66	0.95	2.09	0.2	7.1	6.3	1/4	
FPT-110S-1	3 - 6	2.2 - 4.4	Straight	4,700	Sq 9.5	Sq 3/8	236.5	9.31	0.7	1.54	0.2	7.1	6.3	1/4	
FPT-770SC-1	20 - 35	14.8 - 25.8	Straight	5,500	Sq 9.9	Sq 3/12	274	11	5.1	2.3	0.45	16.0	6.3	1/4	
FPT-770S-1	30 - 45	22 - 33	Straight	5,500	Sq 9.8	Sq 3/11	306	12	3.5	1.6	0.45	16.0	6.3	1/4	
FPT-1660-1	150 - 210	111 - 155	Pistol	2,800	Sq 19.0	Sq 3/4	266	10.5	4.4	9.7	1.2	42.4	9.5	3/8	

TOOL SELECTION GUIDE

Standard models

Model	NORMAL TYPE				CD REPORTING TYPE	
	Square Drive Retainer		Driver Bit Size		Square Drive Retainer	
	P (Hole)	BF (Pin)	Short (-1)	Long (-10)	P (Hole)	BF (Pin)
FPT-110D			541 205 3114	541 205 3116		
FPT-110SD			541 205 3120	541 205 3122		
FPT-110S-1	541 207 2038	541 205 3118			541 207 2039	541 207 2040
FPT-110-1		541 205 3112				
FPT-770S-1	541 207 2069	541 205 3156				
FPT-770SC-1	541 207 2072	541 205 3158			541 210 2708	
FPT-1660-1	541 205 3124					

SQUARE DRIVE ANVIL

P



BF



BIT SIZE

FPT-***SD-1, FPT-***D-1
A:9.5mm B:12mm

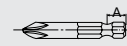

FPT-***SD-10, FPT-***D-10
A:13mm B:16mm



CE certified models

Model	NORMAL TYPE			
	Square Drive Retainer		Driver Bit Size	
	P (Hole)	BF (Pin)	Short (-1)	Long (-10)
FPT-110SD			541 207 2043	
FPT-110D			541 207 2037	
FPT-110S-1		541 207 2042		
FPT-110-1		541 207 2035		
FPT-770S-1		541 207 2070		
FPT-770SC-1		541 207 2073		
FPT-1660-1	541 207 2044			

NPT models

Model	NORMAL TYPE		CD REPORTING TYPE	
	Square Drive Retainer		Square Drive Retainer	
	P (Hole)	BF (Pin)	P (Hole)	BF (Pin)
FPT-110S-1		541 205 3119		541 207 2041
FPT-770SC-1		541 205 3159		
FPT-1660-1	541 205 3125			

IMPACT WRENCHES

Fuji Impact Wrenches FW-44~88 have 9-blade dual chamber motor and double clutch type impact mechanism. They are designed for giving high torque at low speed, which give the best characteristics for fast reliable and accurate tightening. These models are provided with two types of lubricant in clutch part, FW-44PA~66PA and FW-44SA~66SA series are with oil (Oil Bath type) which features long service life and FW-44P~88P and FW-44S~66S are with conventional grease. Both series are suitable for self tapping type soft joint.

PISTOL GRIP - STRAIGHT MODELS

Sq. 9.5 mm (3/8") ~ 12.7 mm (1/2")



GLOBAL SPECIFICATIONS

Model	Recommended Torque Range		Max Torque	Free Speed	Square Drive Size / Bit Shank Size		Socket Retainer	Overall Length (without socket)		Weight (without socket)		Air Consumption (at Load)		Air Hose Size	
	N.m	ft.lb			N.m	min-1		mm	in	mm	in	kg	lb	m ³ /min	ft ³ /min
FW-44SA-1	6 - 12	4.4 - 8.9	20	5,700	9.5	3/8	Pin (BF-Anvil)	207	8.15	0.66	1.46	0.35	12.4	6.3	1/4
FW-66PA-2	12 - 25	8.9 - 18	35	5,000	9.5	3/8	Hole (P-Anvil)	137	5.39	0.88	1.94	0.48	16.9	6.3	1/4
FW-66SA-1	12 - 25	8.9 - 18	35	5,000	9.5	3/8	Pin (BF-Anvil)	212	8.35	0.78	1.72	0.37	13.1	6.3	1/4
FW-88P-1	24 - 40	18 - 30	50	5,300	12.7	1/2	Hole (P-Anvil)	163	6.42	1.4	3.09	0.64	22.5	9.5	3/8

*Air Inlet Thread Size: PT 1/4".

TOOL SELECTION GUIDE

Standard models

Model	Bolt Size	Square Drive Retainer	
		P (Hole)	BF (Pin)
FW-44SA-1	M5	541 207 2421	541 205 3594
FW-66PA-2	M6	541 207 2432	541 205 3646
FW-66SA-1	M6	541 207 2436	541 205 3652
FW-88P-1	M8	541 207 2465	541 205 9592

CE certified models

Model	Bolt Size	Square Drive Retainer
		BF (Pin)
FW-44SA-1	M5	541 207 2422
FW-66PA-2	M6	541 207 2433
FW-66SA-1	M6	541 207 2437

For CE region availability of non CE models, please inquire to your Fuji representative.

NPT models

Model	Bolt Size	Square Drive Retainer
		BF (Pin)
FW-44SA-1	M5	541 205 3595

For possibility of NPT inlet for other models, please inquire to your Fuji representative.

IMPACT WRENCHES

Fuji Impact Wrenches are suitable for various fastening and unfastening operations. The combination of high torque and fast run down minimise operator fatigue.

SMALL SIZE PISTOL GRIP MODELS

Sq. 9.5 mm (3/8") ~ 12.7 mm (1/2") ~ 15.9 mm (5/8")



GLOBAL SPECIFICATIONS

Model	Recommended Torque Range		Max Torque	Free Speed	Square Drive Size / Bit Shank Size		Socket Retainer	Overall Length (without socket)		Weight (without socket)		Air Consumption (at Load)		Air Hose Size	
	N.m	ft.lb			min-1	mm		in	mm	in	kg	lb	m ³ /min	ft ³ /min	mm
FW-5PX-6	6 - 12	4.4 - 8.9	18	12,000	9.5	3/8	Hole (P-Anvil)	150	5.91	0.8	1.76	0.2	7.1	6.3	1/4
FW-6PX-6	8 - 21	5.9 - 15	25	10,000	9.5	3/8	Pin (BF-Anvil)	156	6.14	1.2	2.65	0.28	9.9	9.5	3/8
FW-6PM-1	10 - 17	7.4 - 13	25	8,500	9.5	3/8	Pin (BF-Anvil)	140	5.51	0.92	2.03	0.53	18.7	9.5	3/8
FW-6PX-5	10 - 23	7.4 - 17	28	10,000	9.5	3/8	Pin (BF-Anvil)	156	6.14	1.2	2.65	0.28	9.9	9.5	3/8
FW-6PL-1	12 - 25	8.9 - 18	30	10,000	9.5	3/8	Pin (BF-Anvil)	175	6.89	0.9	1.98	0.2	7.1	9.5	3/8
FW-6PH-1	24 - 45	18 - 33	50	9,000	9.5	3/8	Pin (BF-Anvil)	147	5.79	1.35	2.98	0.35	12.4	9.5	3/8
FW-8PH-3	40 - 60	30 - 44	75	7,500	12.7	1/2	Pin (BF-Anvil)	162	6.38	1.5	3.31	0.4	14.1	9.5	3/8
FW-10PH-1	45 - 65	33 - 48	80	7,500	12.7	1/2	Pin (BF-Anvil)	179	7.05	2	4.41	0.45	15.8	9.5	3/8
FW-10PH-2	47 - 79	35 - 58	100	7,500	12.7	1/2	Pin (BF-Anvil)	179	7.05	2	4.41	0.45	15.9	9.5	3/8
FW-14PX-5	80 - 130	59 - 96	150	6,500	12.7	1/2	Pin (BF-Anvil)	197	7.76	3	6.61	0.4	14.1	9.5	3/8
FW-14PH-1	70 - 110	52 - 81	130	7,500	12.7	1/2	Pin (BF-Anvil)	202	7.95	2.56	5.64	0.6	21.2	9.5	3/8
FW-14PH-2	100 - 160	74 - 118	180	7,500	12.7	1/2	Hole (P-Anvil)	202	7.95	2.56	5.64	0.6	21.2	9.5	3/8
FW-14PH-3	120 - 190	89 - 140	200	7,500	15.9	5/8	Hole (P-Anvil)	202	7.95	2.56	5.64	0.6	21.2	9.5	3/8

TOOL SELECTION GUIDE

Standard models

Model	Bolt Size	Square Drive Retainer	
		P (Hole)	BF (Pin)
FW-5PX-6	M5	541 207 2427	541 205 3600
FW-6PL-1	M6	541 207 2446	541 205 3619
FW-6PM-1	M6	541 207 2448	541 205 3623
FW-6PX-5	M6	541 207 2452	541 205 3629
FW-6PX-6	M6	541 207 2453	541 205 3631
FW-6PH-1	M8	541 207 2440	541 205 3615
FW-6PH-11	M8	541 205 9027	541 205 9026
FW-8PH-3	M10	541 207 2466	541 205 3659
FW-10PH-1 E	M10		541 205 8916
FW-10PH-2 E	M10	541 207 2370	541 205 3533
FW-14PH-1 E	M14		541 205 3539
FW-14PH-2 E	M14	541 207 2380	541 205 3542
FW-14PH-3	M16	541 207 2381	541 210 2802

CE certified models

Model	Bolt Size	Square Drive Retainer	
		P (Hole)	BF (Pin)
FW-6PH-1	M8		541 207 2441
FW-6PH-11	M8		541 207 2444
FW-8PH-3	M10		541 207 2467
FW-10PH-1	M10		541 207 2367
FW-14PH-1	M14		541 207 2377
FW-14PH-2	M14	541 210 2830	541 210 2831

For CE region availability of non CE models, please inquire to your Fuji representative.

NPT models

Model	Bolt Size	Square Drive Retainer	
		P (Hole)	BF (Pin)
FW-5PX-6	M5		541 205 3601
FW-6PX-5	M6		541 205 3630
FW-6PM-1	M6		541 205 3624
FW-6PH-1	M8		541 205 3616
FW-8PH-3	M10		541 205 3660
FW-14PX-5	M14		541 205 3545
FW-14PH-2	M14		541 205 3541
FW-14PH-1	M14		541 205 3540
FW-10PH-2	M10		541 205 3532

For possibility of NPT inlet for other models, please inquire to your Fuji representative.

IMPACT WRENCHES

SMALL SIZE STRAIGHT, ANGLE HEAD MODELS

Sq. 9.5 mm (3/8") ~ 12.7 mm (1/2")



FW-6SX-5~6



FW-8SH-2



FW-10SX-5



FW-14SX-5



FW-6SCX-6



FW-8SCH-2

GLOBAL SPECIFICATIONS

Model	Recommended Torque Range		Max Torque	Free Speed	Square Drive Size / Bit Shank Size		Socket Retainer	Overall Length (without socket)		Weight (without socket)		Air Consumption (at Load)		Air Hose Size	
	N.m	ft.lb			N.m	min-1		mm	in	mm	in	kg	lb	m³/min	ft³/min
FW-6SCX-6	5 - 18	3.7 - 13	20	8,000	9.5	3/8	Hole (P-Anvil)	261	10.3	1.6	3.53	0.3	10.5	9.5	3/8
FW-6SX-6	8 - 21	5.9 - 15	25	10,000	9.5	3/8	Hole (P-Anvil)	223	8.78	1.1	2.43	0.3	10.6	9.5	3/8
FW-6SX-5	10 - 23	7.4 - 17	28	10,000	9.5	3/8	Hole (P-Anvil)	223	8.78	1.1	2.43	0.3	10.6	9.5	3/8
FW-8SCH-2	30 - 50	15 - 37	60	7,500	12.7	1/2	Hole (P-Anvil)	354	13.9	2.7	5.95	0.4	14.1	9.5	3/8
FW-8SH-2	40 - 60	30 - 44	75	8,000	12.7	1/2	Hole (P-Anvil)	306	12	1.7	3.75	0.4	14.1	9.5	3/8
FW-10SX-5	45 - 65	33 - 48	80	8,000	12.7	1/2	Hole (P-Anvil)	317	12.5	2.2	4.85	0.4	14.1	9.5	3/8
FW-14SX-5	80 - 130	59 - 96	150	6,500	12.7	1/2	Hole (P-Anvil)	356	14	3	6.61	0.5	17.7	9.5	3/8

TOOL SELECTION GUIDE

Standard models

Model	Bolt Size	Square Drive Retainer	
		P (Hole)	BF (Pin)
FW-6SX-6	M6	541 207 2460	541 205 3640
FW-6SX-5	M6	541 207 2458	541 205 3639
FW-6SCX-6	M6	541 207 2456	541 205 3637
FW-8SH-2	M10	541 207 2470	541 205 3663
FW-8SCH-2	M10	541 207 2468	541 205 3661
FW-10SX-5	M10	541 207 2374	541 205 3536
FW-14SX-5	M14	541 207 2384	541 205 3546

CE certified models

Model	Bolt Size	Square Drive Retainer
		BF (Pin)
FW-6SX-5	M6	541 207 2459
FW-6SX-6	M6	541 207 2461
FW-8SH-2	M10	541 207 2471
FW-8SCH-2	M10	541 207 2469
FW-14SX-5	M14	541 207 2385

For CE region availability of non CE models, please inquire to your Fuji representative.

NPT models

Model	Bolt Size	Square Drive Retainer
		BF (Pin)
FW-8SH-2	M10	541 205 3664
FW-14SX-5	M14	541 205 3547
FW-6SCX-6	M6	541 205 3638
FW-8SCH-2	M10	541 205 3662

For possibility of NPT inlet for other models, please inquire to your Fuji representative.

ACCESSORIES

CORNER ATTACHMENT (ANGLE HEAD)

The Corner Attachment CA-14A can be mounted on straight or pistol grip type impact wrenches FW-14PX, 14SX to access fastening in confined spaces.



CA-14A



CA-14A + FW-14SX-5



Model	Part Number	Side to Center		Square Drive Size		Angle Head Height		Overall Length		Weight (without socket)		Models
		mm	in	mm	in	mm	in	mm	in	kg	lb	
CA-14A	541 205 1096	24.5	31/32	12.7	1/2	84	3 5/16	146	5 3/4	1.4	3.0	FW-14PX, 14SX Series
CA-14A EC	541 207 0332	24.5	31/32	12.7	1/2	84	3 5/16	146	5 3/4	1.4	3.0	FW-14PX, 14SX Series

IMPACT WRENCHES

MEDIUM SIZE STRAIGHT MODELS

Sq. 19 mm (3/4") ~ 25.4 mm (1") ~ 31.8 mm (1 1/4")



FW-250-1~2



FW-320-1



FW-330-1



FW-420-1C~2C



FW-330-1L



FW-420-1L
(Long Anvil Type)
Outside Lever type



FW-420-1CL
Inside Lever type

GLOBAL SPECIFICATIONS

Model	Recommended Torque Range		Max Torque	Free Speed	Square Drive Size / Bit Shank Size		Socket Retainer	Overall Length (without socket)		Weight (without socket)		Air Consumption (at Load)		Air Hose Size	
	N.m	ft.lb			N.m	min-1		mm	in	mm	in	kg	lb	m ³ /min	ft ³ /min
FW-250-1	380 - 1040	281 - 720	1200	5,000	25.4	1	Hole (P-Anvil)	302	11.9	6	13.2	0.7	24.7	12.7	1/2
FW-250-2	380 - 1040	281 - 720	1200	5,000	19	3/4	Hole (P-Anvil)	302	11.9	6	13.2	0.7	24.7	12.7	1/2
FW-320-1	600 - 1800	444 - 1333	2300	4,800	25.4	1	Hole (P-Anvil)	353	13.9	8.7	19.2	1	35.3	12.7	1/2
FW-330-1	500 - 2100	370 - 1560	2600	5,000	25.4	1	Dual (Ring & hole)	366	14.4	10.7	23.8	1.15	40.6	12.7	1/2
FW-330-1L	500 - 2100	370 - 1560	2600	5,000	25.4	1	Dual (Ring & hole)	522	20.6	12.2	27.1	1.15	40.6	12.7	1/2
FW-420-1	900 - 2500	666 - 1852	2800	4,500	25.4	1	Hole (P-Anvil)	349	13.7	10.8	23.8	1.2	42.4	19	3/4
FW-420-2	900 - 2500	666 - 1852	2800	4,500	31.8	1 1/4	Hole (P-Anvil)	351	13.8	10.8	23.8	1.2	42.4	19	3/4

TOOL SELECTION GUIDE

Standard models

Model	Bolt Size mm	Outside Trigger Model (-)	Inside Trigger Model (C)
FW-250-1	M24	541 205 3554	
FW-250-1C	M24		541 205 3556
FW-250-2 BF	M24	541 205 3558	
FW-250-2 P	M24	541 207 2391	
FW-250-2C BF	M24		541 205 3560
FW-250-2C P	M24		541 207 2392
FW-320-1	M30	541 205 3566	
FW-320-1C	M30		541 205 3569
FW-330-1	M33 - 36	541 210 4115	
FW-330-1L	M33 - 36	541 210 4120	
FW-420-1	M33	541 205 3577	
FW-420-1C	M33		541 205 3579
FW-420-2	M36	541 205 3584	
FW-420-2C	M36		541 205 3586

CE certified models

Model	Bolt Size mm	Outside Trigger Model (-)	Inside Trigger Model (C)
FW-250-1C	M24		541 207 2390
FW-320-1	M30	541 207 2401	
FW-320-1C	M30		541 207 2403
FW-320-1CL	M30		541 207 2406
FW-420-1	M33	541 207 2410	
FW-420-1C	M33		541 207 2412
FW-420-1CL	M33		541 207 2415

For CE region availability of non CE models, please inquire to your Fuji representative.

NPT models

Model	Bolt Size mm	Outside Trigger Model (-)	Inside Trigger Model (C)
FW-250-1 N	M24	541 205 3555	
FW-250-1C N	M24		541 205 3557
FW-250-2C BF N	M24		541 205 3561
FW-320-1 N	M30	541 207 2400	
FW-320-1C N	M30		541 205 3568
FW-320-1L N	M30	541 205 3573	
FW-330-1C N	M33 - 36		541 210 4155
FW-330-1CL N	M33 - 36		541 210 4149
FW-420-1 N	M33	541 205 3576	
FW-420-1C N	M33		541 205 3578
FW-420-2 N	M36	541 205 3585	

For possibility of NPT inlet for other models, please inquire to your Fuji representative.



IMPACT WRENCHES

MEDIUM SIZE PISTOL MODELS

Sq. 19 mm (3/4") ~ 25.4 mm (1")



FW-190P



FW-250P-1~2



FW-320P-1

GLOBAL SPECIFICATIONS

Model	Recommended Torque Range		Max Torque	Free Speed	Square Drive Size / Bit Shank Size		Socket Retainer	Overall Length (without socket)		Weight (without socket)		Air Consumption (at Load)		Air Hose Size	
	N.m	ft.lb			N.m	min-1		mm	in	mm	in	kg	lb	m ³ /min	ft ³ /min
FW-190P-1	240 - 560	178 - 415	620	5,500	19	3/4	Hole (P-Anvil)	241	9.5	4.5	10	0.52	18.2	9.5	3/8
FW-250P-1	380 - 1040	281 - 720	1200	5,000	25.4	1	Hole (P-Anvil)	228	8.98	5.3	11.7	0.7	24.7	12.7	1/2
FW-250P-2	380 - 1040	281 - 720	1200	5,000	19	3/4	Hole (P-Anvil)	228	8.98	5.3	11.7	0.7	24.7	12.7	1/2
FW-320P-1	600 - 1800	444 - 1333	2300	4,800	25.4	1	Hole (P-Anvil)	268	10.6	8	17.6	1	35.3	12.7	1/2
FW-330P-1	500 - 2100	370 - 1560	2600	5,000	25.4	1	Dual (Ring & hole)	283	11.1	10.4	23.1	1.15	40.6	12.7	1/2

TOOL SELECTION GUIDE

Standard models

Model	Bolt Size	Square Drive Retainer		
		P (Hole)	BF (Pin)	Dual
FW-190P-1		541 210 4397	541 210 4398	
FW-250P-1	M24	541 205 3562		
FW-250P-2	M24	541 207 2394	541 205 3564	
FW-320P-1 E	M30	541 205 3575		
FW-330P-1	M33 - 36			541 210 4110

CE certified models

Model	Bolt Size	Square Drive Retainer	
		P (Hole)	BF (Pin)
FW-190P-1		541 210 4404	
FW-250P-1	M24	541 207 2393	
FW-250P-2	M24		541 207 2395
FW-320P-1	M30	541 207 2408	

For CE region availability of non CE models, please inquire to your Fuji representative.

NPT models

Model	Bolt Size	Square Drive Retainer	
		P (Hole)	BF (Pin)
FW-190P-1			541 210 4399
FW-250P-1	M24	541 205 3563	
FW-250P-2	M24		541 205 3565
FW-320P-1	M30	541 205 3574	
FW-330P-1	M33 - 36	541 210 4154	

For possibility of NPT inlet for other models, please inquire to your Fuji representative.

HIGH TORQUE SUPER HEAVY DUTY MODELS

Sq. 38.1 mm (1 1/2") ~ 63.5 mm (2 1/2")



FW-50-7

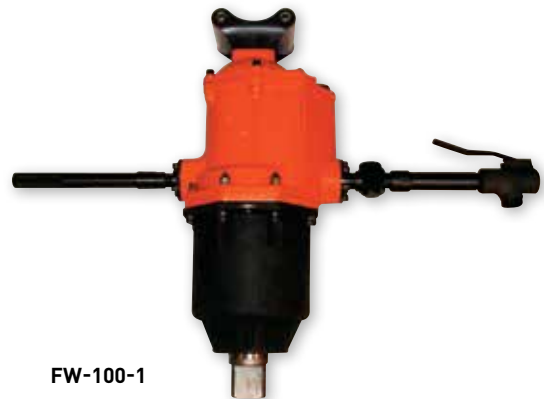

FW-100-1

GLOBAL SPECIFICATIONS

Model	Recommended Torque Range		Max Torque	Free Speed	Square Drive Size / Bit Shank Size		Socket Retainer	Overall Length (without socket)		Weight (without socket)		Air Consumption (at Load)		Air Hose Size	
	N.m	ft.lb			N.m	min-1		mm	in	mm	in	kg	lb	m ³ /min	ft ³ /min
FW-50-7	4400 - 5900	3250 - 4350	6000	4,000	38	1 1/2	Hole (P-Anvil)	500	19.7	33	72.8	1.91	67.3	19	3/4
FW-75-7	5800 - 11300	4280 - 8330	12000	3,000	63.5	2 1/2	Hole (P-Anvil)	610	24	60	132	2.12	74.9	19	3/4
FW-100-1	11000 - 16000	8113 - 11800	17000	2,500	63.5	2 1/2	Hole (P-Anvil)	700	27.6	85	187	3.23	114.0	25.4	1

TOOL SELECTION GUIDE

Standard models

Model	Bolt Size	Square Drive Retainer
		P (Hole)
FW-50-7 E	M50	541 205 3614
FW-75-7 E	M68	541 205 3658
FW-100-1 E	M76	541 205 3538

For possibility of NPT inlet for other models, please inquire to your Fuji representative.

CE certified models

Model	Bolt Size	Square Drive Retainer
		P (Hole)
FW-50-7 EC	M50	541 207 2426
FW-75-7 EC	M68	541 207 2464
FW-100-1 EC	M76	541 207 2366

For CE region availability of non CE models, please inquire to your Fuji representative.

SCREWDRIVERS

Fuji screwdrivers are suitable for a wide range of screw fastening and disassembly applications.

The compact and lightweight design provides operator comfort. All models are reversible via a reverse lever or push button. Impact clutch type models are all of double clutch design and their high torque and fast run-down minimise operator fatigue. Slip clutch type models are suitable for sheet metal screws and the torque setting can be adjusted easily.

IMPACT CLUTCH TYPE (2 HAMMERS)

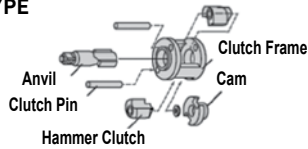

SLIP CLUTCH TYPE



IMPACT CLUTCH TYPE - STRAIGHT MODELS

Hex. 6.35 mm (1/4")



FW-5SXD-7(70)



FW-5SXD-8(80)



FW-6SXD-6(60)

GLOBAL SPECIFICATIONS

Model	Bolt Size	Recommended Torque Range		Free Speed	Bit Shank Size		Socket Retainer	Overall Length (without socket)		Weight (without socket)		Air Consumption (at Load)		Air Hose Size	
		mm	N.m		ft.lb	min-1		mm	in	mm	in	kg	lb	m ³ /min	ft ³ /min
FW-5SXD-7	M5	3 - 8	2.2 - 5.9	12,000	Hex. 6.35	1/4" Hex.	Bit Shank (Hex)	223	8.78	0.7	1.54	0.2	7.1	6.3	1/4
FW-6SXD-8	M5	3 - 8	2.2 - 5.9	12,000	Hex. 6.35	1/4" Hex.	Bit Shank (Hex)	193	7.6	0.65	1.43	0.2	7.1	6.3	1/4
FW-44SAD-1	M5	5 - 10	3.7 - 7.4	5,700	Hex. 6.35	1/4" Hex.	Bit Shank (Hex)	207	8.15	0.66	1.46	0.35	12.4	6.3	1/4
FW-6SXD-6	M6	5 - 10	3.7 - 7.4	10,000	Hex. 6.35	1/4" Hex.	Bit Shank (Hex)	235	9.25	1.1	2.43	0.3	10.6	9.5	3/8
FW-66SAD-1	M6	14 - 20	10.3 - 15	5,000	Hex. 6.35	1/4" Hex.	Bit Shank (Hex)	218	8.58	0.78	1.72	0.37	13.1	6.3	1/4

TOOL SELECTION GUIDE

Standard models

Model	Bolt Size	Driver Bit Size		
		mm	Short	Long
FW-5SXD-7	M5	541 205 3606		
FW-5SXD-70 E	M5	541 205 3609		
FW-5SXD-8	M5	541 205 3610		
FW-5SXD-80 E	M5	541 205 3613		
FW-6SXD-6	M6	541 205 3642		
FW-6SXD-60	M6		541 205 3644	
FW-44SAD-1 E	M5	541 205 3597		
FW-44SAD-10	M5		541 205 3598	

CE certified models

Model	Bolt Size	Driver Bit Size	
		mm	Short
FW-44SAD-1	M5	541 207 2424	
FW-5SXD-7	M5	541 207 2428	
FW-5SXD-8	M5	541 207 2430	
FW-66SAD-1	M6	541 207 2439	
FW-6SXD-6	M6	541 207 2462	

For CE region availability of non CE models, please inquire to your Fuji representative.

NPT models

Model	Bolt Size	Driver Bit Size	
		mm	Short
FW-44SAD-10	M5	541 205 3599	
FW-5SXD-8	M5	541 205 3611	

For possibility of NPT inlet for other models, please inquire to your Fuji representative.

BIT SIZE

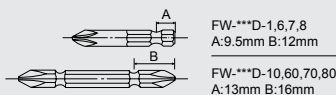

SCREWDRIVERS

IMPACT CLUTCH TYPE - PISTOL MODELS

Hex. 6.35 mm (1/4")



FW-5PXD-6(60)

FW-6PLD-1

FW-6PXD-6(60)

GLOBAL SPECIFICATIONS

Model	Bolt Size	Recommended Torque Range		Free Speed	Bit Shank Size		Socket Retainer	Overall Length (without socket)		Weight (without socket)		Air Consumption (at Load)		Air Hose Size	
		mm	N.m		ft.lb	mm		in	mm	in	kg	lb	m ³ /min	ft ³ /min	mm
FW-5PXD-6	M5	2 - 7	1.5 - 5.2	12,000	Hex. 6.35	1/4" Hex.	Bit Shank (Hex)	160	6.3	0.8	1.76	0.2	7.1	6.3	1/4
FW-44PAD-2	M5	5 - 10	3.7 - 7.4	6,500	Hex. 6.35	1/4" Hex.	Bit Shank (Hex)	132	5.2	0.78	1.72	0.6	21.2	6.3	1/4
FW-6PLD-1	M6	10 - 18	7.4 - 13	10,000	Hex. 6.35	1/4" Hex.	Bit Shank (Hex)	182	7.17	0.9	1.98	0.2	7.1	9.5	3/8
FW-6PMD-1	M6	10 - 18	7.4 - 13	8,500	Hex. 6.35	1/4" Hex.	Bit Shank (Hex)	146	5.75	0.92	2.03	0.53	18.7	9.5	3/8
FW-6PXD-6	M6	10 - 18	7.4 - 13	10,000	Hex. 6.35	1/4" Hex.	Bit Shank (Hex)	168	6.61	1.2	2.65	0.28	9.9	9.5	3/8
FW-66PAD-2	M6	14 - 20	10.3 - 15	5,000	Hex. 6.35	1/4" Hex.	Bit Shank (Hex)	143	5.63	0.88	1.94	0.48	16.9	6.3	1/4
FW-6PHD-1	M8	20 - 40	15 - 30	9,000	Hex. 6.35	1/4" Hex.	Bit Shank (Hex)	154	6.06	1.35	2.98	0.35	12.4	9.5	3/8

TOOL SELECTION GUIDE

Standard models

Model	Bolt Size	Driver Bit Size	
		Short	Long
FW-44PAD-2	M5	541 205 3591	
FW-44PAD-20	M5		541 205 3592
FW-5PXD-6	M5	541 205 3602	
FW-5PXD-60	M5		541 205 3604
FW-66PAD-2	M6	541 205 3649	
FW-66PAD-20	M6		541 205 3650
FW-6PHD-1	M8	541 205 3618	
FW-6PLD-1	M6	541 205 3621	
FW-6PMD-1	M6	541 205 3626	
FW-6PMD-10	M6		541 205 3627
FW-6PXD-6	M6	541 205 3633	
FW-6PXD-60	M6		541 205 3635

CE certified models

Model	Bolt Size	Driver Bit Size	
		Short	Long
FW-44PAD-2 EC	M5	541 207 2418	
FW-66PAD-2 EC	M6	541 207 2435	
FW-6PLD-1 EC	M6	541 207 2447	
FW-6PMD-1 EC	M6	541 207 2450	
FW-6PMD-10 EC	M6		541 207 2451
FW-6PXD-6 EC	M6	541 207 2454	
FW-6PXD-60 EC	M6		541 207 2455

For CE region availability of non CE models, please inquire to your Fuji representative.

NPT models

Model	Bolt Size	Driver Bit Size
		Short
FW-5PXD-6 N	M5	541 205 3603
FW-6PHD-1 N	M8	541 205 3617
FW-6PLD-1 N	M6	541 205 3622
FW-6PMD-1 N	M6	541 205 3625
FW-6PXD-6 N	M6	541 205 3634
FW-44PAD-2 N	M5	541 205 3590

For possibility of NPT inlet for other models, please inquire to your Fuji representative.

SLIP CLUTCH TYPE - STRAIGHT / PISTOL MODELS

Hex. 6.35 mm (1/4")



FD-4
FD-5

FD-4P
FD-5P

GLOBAL SPECIFICATIONS

Model	Bolt Size	Recommended Torque Range		Free Speed	Square Drive Size / Bit Shank Size		Overall Length (without socket)		Weight (without socket)		Air Consumption (at Load)		Air Hose Size	
		mm	N.m		ft.lb	mm	in	mm	in	kg	lb	m ³ /min	ft ³ /min	mm
FD-4	M4	1.0 - 2.0	0.7 - 1.5	2,000	Hex. 6.35	1/4" Hex.	174	6.85	0.6	1.32	0.2	7.1	6.3	1/4
FD-4P	M4	1.0 - 2.0	0.7 - 1.5	2,000	Hex. 6.35	1/4" Hex.	173	6.81	0.8	1.7	0.2	7.1	6.3	1/4
FD-5	M5	6.0 - 10.0	4.4 - 7.4	1,600	Hex. 6.35	1/4" Hex.	233	9.17	1	2.2	0.3	10.6	6.3	1/4
FD-5P	M5	6.0 - 10.0	4.4 - 7.4	1,600	Hex. 6.35	1/4" Hex.	216	8.5	1.2	2.6	0.3	10.6	6.3	1/4

TOOL SELECTION GUIDE

Standard models

Model	Bolt Size	Part Number
		mm
FD-4	M4	541 205 2570
FD-4P	M4	541 205 2574
FD-5	M5	541 205 2578
FD-5P	M5	541 205 2581

CE certified models

Model	Bolt Size	Part Number
		mm
FD-5 EC	M5	541 207 1308
FD-5P EC	M5	541 207 1311

For CE region availability of non CE models, please inquire to your Fuji representative.

NPT models

Model	Bolt Size	Part Number
		mm
FD-4 N	M4	541 205 2569
FD-5 N	M5	541 205 2577
FD-5P N	M5	541 205 2582

For possibility of NPT inlet for other models, please inquire to your Fuji representative.

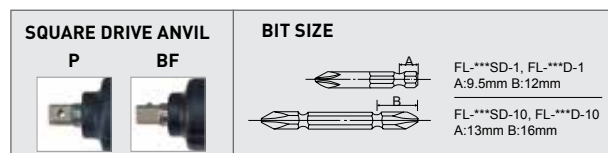

RATCHET AND OPEN-END WRENCHES

OPEN-END WRENCHES



FOW-10-1



FOW-10-2

GLOBAL SPECIFICATIONS

Model	Max Torque		Free Speed min ⁻¹	Head Size				Overall Length		Weight		Air Consumption (at Load)		Air Hose Size	
	N.m	ft.lb		Thickness		Width		mm	in	kg	lb	m ³ /min	ft ³ /min	mm	in
FOW-10-1	13.6	10	410	14	0.55	36	1.42	294	11.6	1.5	3.3	0.4	6.7	9.5	3/8
FOW-10-2	18.5	13.6	300	14	0.55	40	1.57	306	12	1.6	3.5	0.4	6.7	9.5	3/8

TOOL SELECTION GUIDE

Standard models

Socket	8 mm	10 mm	11 mm	12 mm	13 mm	14 mm
Model						
FOW-10-1	541 205 3083	541 205 3085				
FOW-10-2 10		541 205 3091	541 205 3092	541 205 3093	541 205 3094	541 205 3095

HEAD SIZE

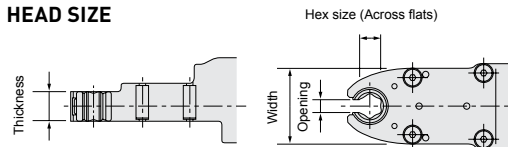

CE certified models

Socket	10 mm	11 mm	12 mm	13 mm	14 mm
Model					
FOW-10-1 EC	541 207 2024				
FOW-10-2 EC		541 207 2025	541 207 2026	541 207 2027	541 207 2028

NPT models

Socket	9 mm	10 mm	3/8"
Model			
FOW-10-1 N	541 205 3090	541 205 3088	541 205 3089

For other sizes of sockets, please ask Fuji

RATCHET WRENCHES

Ratchet Wrenches are used for fastening operations in confined spaces where angle impact tools and nutrunners cannot reach. Reverse operation can be accomplished by simply turning the wrench over.



FRW-6NX-3, ~4(A)



FRW-8NX-2, ~2(A)



FRW-13N-3, ~4

GLOBAL SPECIFICATIONS

Model	Bolt Size	Max Torque		Free Speed min ⁻¹	Head Size				Overall Length		Weight		Air Consumption (at Load)		Air Hose Size	
		N.m	ft.lb		Thickness		Width		mm	in	kg	lb	m ³ /min	ft ³ /min	mm	in
FRW-6NX-3	M6	10.8	8.1	200	13	0.51	20	0.79	316	12.4	1.2	2.6	0.25	4.2	9.5	3/8
FRW-6NX-3A	M6	10.8	8.1	200	10	0.39	20	0.79	316	12.4	1.2	2.6	0.25	4.2	9.5	3/8
FRW-6NX-4	M6	12.7	9.4	170	13	0.51	24	0.94	320	12.6	1.2	2.6	0.25	4.2	9.5	3/8
FRW-6NX-4A	M6	12.7	9.4	170	10	0.39	24	0.94	320	12.6	1.2	2.6	0.25	4.2	9.5	3/8
FRW-8NX-2	M8	29.4	22.1	200	18	0.71	25	0.98	378	14.9	2.2	4.9	0.43	7.2	9.5	3/8
FRW-8NX-2A	M8	29.4	22.1	200	10	0.39	25	0.98	378	14.9	2.1	4.6	0.43	7.2	9.5	3/8
FRW-10N-2	M10	44.1	33.1	140	18	0.71	33	1.3	417	16.4	2.7	6	0.58	9.7	9.5	3/8
FRW-13N-3	M12	58.8	44.1	130	18	0.71	36	1.42	419	16.5	2.7	6	0.58	9.7	9.5	3/8
FRW-13N-4	M12	78.4	58.8	100	18	0.71	46	1.81	431	17	3	6.6	0.58	9.7	9.5	3/8

RATCHET AND OPEN-END WRENCHES

RATCHET WRENCHES

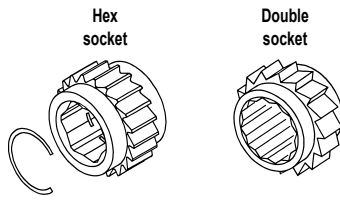

HEAD SIZE

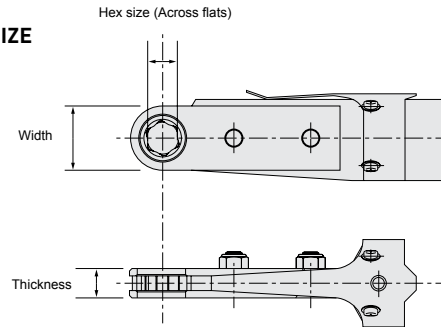

RATCHET SELECTION BY SOCKETS

STANDARD MODELS

FROM 8 TO 27

Socket	8 mm	8 DOUBLE	10 mm	10 DOUBLE	12 mm	12 DOUBLE	13 mm	13 DOUBLE	14 mm	14 DOUBLE	15 mm	16 mm	17 mm	17 DOUBLE
Model														
FRW-6NX-3	541 205 3438	541 205 3443	541 205 3439	541 205 3442										
FRW-6NX-3A	541 205 3444		541 205 3445											
FRW-6NX-4					541 205 3448		541 205 3449	541 205 3452						
FRW-6NX-4A					541 205 3454		541 205 3455							
FRW-8NX-2	541 205 3458				541 205 3459	541 205 3470	541 205 3460		541 205 3461	541 205 3468				
FRW-8NX-2A			541 205 3472		541 205 3473		541 205 3474		541 205 3475					
FRW-10N-2							541 205 3404		541 205 3405	541 210 2801	541 205 9021	541 205 3409	541 205 3406	541 205 3414

Socket	14 mm	17 mm	18 mm	19 mm	21 mm	21 DOUBLE	22 mm	22 DOUBLE	24 mm	24 DOUBLE	26 mm	27 mm
Model												
FRW-13N-3		541 205 9022	541 205 3418	541 205 3416	541 205 3417	541 205 3420						
FRW-13N-4	541 206 0428	541 210 2726	541 205 3431	541 205 3424			541 205 3425	541 205 3433	541 205 3426	541 205 3432	541 205 3427	541 205 3428

For inches specifications sockets, please contact Fuji representative

CE certified models

FROM 8 TO 27

Socket	8 mm	8 DOUBLE	10 mm	12 mm	12 double	13 mm	14 mm	17 mm
Model								
FRW-6NX-3	541 207 2306	541 210 2997	541 207 2305					
FRW-6NX-3A	541 207 2309		541 207 2307					
FRW-6NX-4						541 207 2310		
FRW-8NX-2			541 207 2311			541 207 2313	541 207 2314	
FRW-8NX-2A				541 207 2315		541 207 2316	541 207 2317	
FRW-10N-2						541 210 2843	541 207 2282	541 207 2283

Socket	14 mm	17 mm	18 mm	19 mm	24 mm	27 mm
Model						
FRW-13N-3		541 207 2286	541 207 2287	541 207 2288		
FRW-13N-4	541 207 2290	541 210 3148	541 207 2291	541 207 2292	541 207 2293	541 207 2294

For inches specifications sockets, please contact Fuji representative

NPT models

FROM 8 TO 27

Socket	10 mm	12 mm
Model		
FRW-6NX-3A	541 205 3447	
FRW-8NX-2		541 205 3464

For inches specifications sockets, please contact Fuji representative

Socket	19 mm	24 mm	27 mm
Model			
FRW-13N-3	541 205 3422	541 205 3430	541 205 3436



RATCHET AND OPEN-END WRENCHES

ACCESSORIES

OPEN-END WRENCH SOCKET LIST

Open-end wrench	Item N°	Part number	Name	Size
FOW-10-1	W-278540-30	541 205 7541	Socket	8
	W-278540-31	541 205 7542	Socket	9
	W-278540-33	541 205 7544	Socket	3/8"
FOW-10-2	W-278540-40	541 205 7545	Socket	10
	W-278540-41	541 205 7546	Socket	11
	W-278540-42	541 205 7547	Socket	12
	W-278540-43	541 205 7548	Socket	13

RATCHET SOCKET LIST

Sockets for FRW-6NX-3A, 4A, 8NX-2A are special, please ask Fuji representative.

Ratchet Wrenches	Item N°	Part number	Name	Size
FRW-6NX-3	W-272440-00	541 207 5944	Retaining ring	8
	W-272540-20	541 205 7366	Socket	8
	W-272440-01	541 205 7342	Retaining ring	10
	W-272540-21	541 205 7367	Socket	10
FRW-6NX-4	W-272440-10	541 205 7343	Retaining ring	12
	W-272540-30	541 205 7368	Socket	12
	W-272440-11	541 205 7344	Retaining ring	13
	W-272540-31	541 205 7369	Socket	13
FRW-6NX-3	W-272540-01	541 207 5950	Socket	8W
	W-272540-00	541 205 7362	Socket	10W
FRW-6NX-4	W-272540-11	541 205 7363	Socket	12W
	W-272540-12	541 205 7364	Socket	13W

Ratchet Wrenches	Item N°	Part number	Name	Size
FRW-8NX-2	W-272440-01	541 205 7342	Retaining ring	10
	W-273540-10	541 205 7404	Socket	10
	W-272440-10	541 205 7343	Retaining ring	12
	W-273540-11	541 205 7405	Socket	12
	W-272440-11	541 205 7344	Retaining ring	13
	W-273540-12	541 205 7345	Socket	13
	W-273440-00	541 205 7387	Retaining ring	14
	W-273540-13	541 205 7407	Socket	14
FRW-8NX-2	W-273540-02	541 205 7403	Socket	12W
	W-273540-01	541 205 7402	Socket	13W
	W-273540-00	541 205 7401	Socket	14W

Ratchet Wrenches	Item N°	Part number	Name	Size
FRW-10N-2	W-272440-11	541 205 7344	Ring	13
	W-274540-16	541 205 7448	Socket	13
	W-273440-00	541 205 7387	Retaining ring	14
	W-274540-10	541 205 7445	Socket	14
	W-274540-17	541 205 9016	Ring	15
	W-274440-02	541 207 5974	Socket	15
	W-274440-01	541 207 5973	Retaining ring	16
	W-274540-15	541 205 7450	Socket	16
	W-274440-00	541 205 7429	Retaining ring	17
	W-274540-11	541 205 7446	Socket	17
FRW-10N-2	W-274540-01	541 205 7444	Socket	14W
	W-274540-00	541 205 7443	Socket	17W

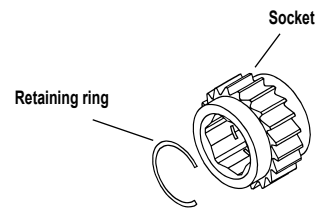

Ratchet Wrenches	Item N°	Part number	Name	Size
FRW-13N-3	W-274440-00	541 205 7429	Ring	17
	W-275540-13	541 205 8994	Socket	17
	W-275440-02	541 205 7452	Retaining ring	18
	W-275540-12	541 205 7467	Socket	18
	W-275440-00	541 205 7450	Retaining ring	19
	W-275540-10	541 205 7465	Socket	19
	W-275440-01	541 205 7451	Retaining ring	21
	W-275540-00	541 205 7459	Socket	21
FRW-13N-4	W-273440-00	541 205 7387	Ring	14
	W-275540-38	541 207 5983	Socket	14
	W-274440-00	541 205 7429	Ring	17
	W-275540-37	541 207 5982	Socket	17
	W-275440-02	541 205 7452	Ring	18
	W-275540-35	541 207 5981	Socket	18
	W-275440-00	541 205 7450	Ring	19
	W-275540-36	541 205 7472	Socket	19
	W-275440-10	541 205 7453	Retaining ring	22
	W-275540-30	541 205 7468	Socket	22
	W-275440-11	541 205 7454	Retaining ring	24
	W-275540-31	541 205 7469	Socket	24
	W-275440-12	541 205 7455	Retaining ring	26
	W-275540-32	541 205 7470	Socket	26
	W-275440-13	541 207 5979	Retaining ring	27
W-275540-33	541 205 7471	Socket	27	

Ratchet Wrenches	Item N°	Part number	Name	Size
FRW-13N-3	W-275540-00	541 205 7459	Socket	21W
	W-275540-01	541 205 7460	Socket	19W
FRW-13N-4	W-275540-02	541 205 7461	Socket	24W
	W-275540-03	541 205 7462	Socket	27W
	W-275540-04	541 205 7463	Socket	22W
	W-275540-05	541 205 7464	Socket	25W



ABRASIVE TOOLS

INSTRUCTION AND WARNING FOR SAFETY USE _____	42
ABRASIVE TOOLS FEATURES _____	43
PENCIL & TURBO GRINDERS _____	44
DIE GRINDERS _____	45
DIE GRINDERS FOR MOUNTED POINT _____	46
LOW-SPEED & STRAIGHT GRINDERS _____	49
EXTENDED GRINDERS _____	51
ANGLE GRINDERS / SMALL TO LARGE _____	53
VERTICAL GRINDERS - VERTICAL SANDERS _____	59
ANGLE SANDERS _____	60
BELT SANDERS _____	61
ORBITAL SANDERS _____	62
ACCESSORIES _____	63

INSTRUCTION AND WARNING FOR SAFETY USE

GRINDERS AND SANDERS

INTENDED USE

The tool is designed to be used with abrasive product for grinding, cutting and sanding materials. Do not use the tool for any other purpose.

PROTECTIVE EQUIPMENT

Always wear necessary protective equipment such as an eye protector, an ear protector, a face shield, a safety apron, a helmet, gloves and other necessary protective clothing. Use protective barriers where necessary



MAXIMUM SPEEDS OF ABRASIVE PRODUCT AND TOOL

Always check the spindle speed of the tool when mounting the abrasive product. Ensure that the maximum free speed rating of the abrasive product is above that of the tool in use.

WHEEL SIZES OF ABRASIVE PRODUCT AND PERIPHERAL SPEED

The following is a reference of Grinding wheel size / Peripheral speed / Maximum free speed. When using abrasive product, on which the peripheral speed is shown instead of the maximum allowable free speed, refer to the reference.

Wheel diameter - Peripheral speed - Maximum free speed

Grinding Wheel diameter	Peripheral Speed (m/s)														
	10	15	20	25	28	30	33	35	40	45	48	50	60	70	80
mm	Maximum free speed (min ⁻¹)														
25	7639	11459	15279	19099	21390	22918	25210	26738	30558	34377	36669	38197	45837	53476	61115
40	4775	7162	9549	11937	13369	14324	15756	16711	19099	21486	22918	23873	28648	33423	38197
50	3820	5730	7639	9549	10695	11459	12605	13369	15279	17189	18335	19099	22918	26738	30558
63	3032	4547	6063	7579	8488	9095	10004	10610	12126	13642	14551	15158	18189	21221	24252
80	2387	3581	4775	5968	6685	7162	7878	8356	9549	10743	11459	11937	14324	16711	19099
100	1910	2865	3820	4775	5348	5730	6303	6685	7639	8594	9167	9549	11459	13369	15279
115	1661	2491	3321	4152	4650	4982	5480	5813	6643	7473	7972	8304	9964	11625	13286
125	1528	2292	3056	3820	4278	4584	5042	5348	6112	6875	7334	7639	9167	10695	12223
150	1273	1910	2546	3183	3565	3820	4202	4456	5093	5730	6112	6366	7639	8913	10186
180	1061	1592	2122	2653	2971	3183	3501	3714	4244	4775	5093	5305	6366	7427	8488
200	955	1432	1910	2387	2674	2865	3151	3342	3820	4297	4584	4775	5730	6685	7639
230	830	1246	1661	2076	2325	2491	2740	2906	3321	3737	3986	4152	4982	5813	6643
250	764	1146	1528	1910	2139	2292	2521	2674	3056	3438	3667	3820	4584	5348	6112
300	637	955	1273	1592	1783	1910	2101	2228	2546	2865	3056	3183	3820	4456	5093

CORRECT WHEEL GUARD AND FLANGES FOR GRINDER

Always use the wheel guard and wheel flanges supplied with the tool and ensure that they are mounted correctly with the appropriate tightness when mounting the abrasive product. Only trained & qualified personnel should mount the abrasive product. Do not use a wheel guard or the flanges if they are damaged or worn. Do not modify or repair a wheel guard or flanges.

CORRECT ABRASIVE PRODUCT TO CORRECT TOOL

Make sure the dimensions of the abrasive product are compatible with the tool and that the abrasive product fits the spindle of the tool.

MOUNTING AND DISMOUNTING ABRASIVE PRODUCT

When mounting and dismounting the abrasive product, make sure to disconnect tool. Make sure the dimensions of the abrasive product are compatible with the tool and that the abrasive product fits the spindle of the tool.

TOOL WITH SPEED GOVERNOR

For the grinder with a speed governor, check the maximum free speed regularly.

Make it a rule to check the maximum free speed, whenever before use.

ABRASIVE TOOLS FEATURES

REAR EXHAUST

The rear exhaust reduces the risk of scattering debris such as grindings, shavings, etc. due to the exhaust air direction.

In addition, when using the inlet and exhaust hoses supplied with the tools, this helps to reduce the sound level.



CENTRIFUGAL SPEED GOVERNOR

The speed governor maintains the working speed of the tool to a better degree than a conventional tool without a governor. Consequently, the abrasive life is improved due to the stability of the cutting speed. It is less susceptible to changes in air pressure and wear of the governor parts.

ANGLE, STRAIGHT, VERTICAL GRINDERS

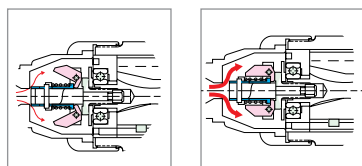

ANTI-FREEZING SWIVEL SILENCER

The anti-freezing swivel silencer minimises the effect of freezing during operation of the tool. In addition, it also enables the operator to direct the exhaust air to provide maximum operator comfort.

ANGLE GRINDERS EXCEPT FA-2C, FA-30, 150K SERIES



GEAR COOLING DEVICE

The patented gear cooling device helps to minimise wearing of the bevel gear and pinion by metering some exhaust air through them and providing a cooling effect.

ANGLE GRINDERS



SELECTION OF THROTTLE TYPE

The Fuji grinders are available with 4 different handle configurations depending on the customer requirement. Locking lever helps to reduce the risk of inadvertent starting of the tool. The operator needs to push the locking lever (-F type) or the locking button (-M type) to start operation of the tool. When the lever is released, the tool automatically reverts to the locked condition.

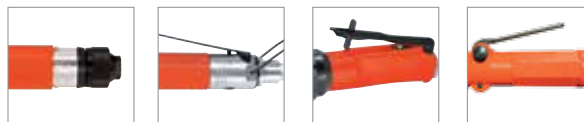

Roll Throttle

Lever

Locking Lever (-F)

Locking Lever (-M)

ACCURATE COLLET ALIGNMENT

The collet is mounted in the spindle in order to provide minimal deflection.

Furthermore, the compact collet nut enables finishing operations in confined spaces.



STURDY STEEL HOUSING

Die Grinders feature a compact and durable steel housing for longer service life.



PENCIL GRINDERS / TURBO GRINDERS

TURBO GRINDERS

Super high speed operation provides a more precise finish. Ø3mm or Ø1/8" and Ø6mm or Ø1/4" collet sizes are available to suit the application.

MAX. DIAMETER OF ABRASIVES

Please use correct diameter of mounted points and carbide burrs for the speed.



TURBO-100



TURBO-100A

Mounted Point		Burr Head	
mm	in	mm	in
8	5/16	6	1/4

GLOBAL SPECIFICATIONS

Model	Collet Size		Throttle	Exhaust	Free Speed	Power		Overall Length		Weight		Max. Air Consumption		Air Hose Size	
	mm	in				min ⁻¹	W	hp	mm	in	kg	lb	m ³ /min	ft ³ /min	mm
TURBO-100 3	3	-	Roll Throttle	Front exhaust	80,000,100,000	50W	0.1	153	6.02	0.25	0.55	0.28	9.8	4	5/32
TURBO-100A 6	6	-	Roll Throttle	Front exhaust	80,000,100,000	50W	0.1	155	6.1	0.2	0.4	0.28	9.8	4	5/32

Air Inlet Thread Size: PT 1/8"

TOOL SELECTION GUIDE

STANDARD MODELS

Model	Collet Size	
	3 mm	6 mm
TURBO-100 3	541 205 6525	
TURBO-100A 6		541 205 6529

CE certified models

Model	Collet Size		
	3 mm	6 mm	1/4"
TURBO-100 3 EC	541 207 5665		
TURBO-100A 6 EC		541 207 5669	541 207 5668

For CE region availability of non CE models, please inquire to your Fuji representative.

NPT models

Model	Collet Size		
	3 mm	6 mm	1/4"
TURBO-100 3 N	541 205 6523		
TURBO-100A 6 N		541 205 6527	541 207 5668

For possibility of NPT inlet for other models, please inquire to your Fuji representative.

PENCIL GRINDER

Pencil Grinders are excellent tools for deburring, contouring and light grinding when used with a rotary burr. The small compact diameter, and light weight, aid precise application.



FG-06-1



FG-06S-1



MAX. DIAMETER OF ABRASIVES

Please use correct diameter of mounted points and carbide burrs for the speed.

Mounted Wheel		Burr Head	
mm	in	mm	in
10	3/8	6	1/4

GLOBAL SPECIFICATIONS

Model	Collet Size		Throttle	Exhaust	Free Speed	Power		Overall Length		Weight		Max. Air Consumption		Air Hose Size	
	mm	in				min ⁻¹	W	hp	mm	in	kg	lb	m ³ /min	ft ³ /min	mm
FG-06-1	3	-	Roll throttle	Rear exhaust	60,000	90	0.121	153	6.02	0.15	0.33	0.17	6	4	5/32
FG-06S-1	3	1/8	Roll throttle	Rear exhaust	60,000	90	0.121	166	6.54	0.13	0.29	0.17	5.97	4	5/32

TOOL SELECTION GUIDE

STANDARD MODELS

Model	Collet Size	
	3 mm	1/8"
FG-06-1	541 205 2686	
FG-06S-1	541 207 8461	541 210 2978

CE certified models

Model	Collet Size	
	3 mm	1/8"
FG-06S-1	541 210 3168	541 210 3008

For CE region availability of non CE models, please inquire to your Fuji representative.

NPT models

Model	Collet Size	
	3 mm	1/8"
FG-06S-1	541 210 2979	541 210 2980

For possibility of NPT inlet for other models, please inquire to your Fuji representative.

FG-12U SERIES

FG-12U series are featured with an ergonomic spindle design supported by double bearings and connected to the motor spindle via a coupling. Together with this design 40,000rpm of speed provide the high accuracy and low vibration. Best tools for grinding with carbide burrs.

MAX. DIAMETER OF ABRASIVES

Please use correct diameter of mounted points and carbide burrs for the speed.

Mounted Point		Burr Head	
mm	in	mm	in
13	1/2	8	5/16

REAR EXHAUST MODEL (WITH HOSE)



MAIN FEATURES

- High accuracy spindle, coupling, double bearing
- High speed 43000rpm
- Low vibration

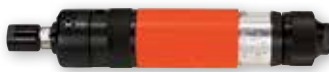

FG-12U-2



FG-12U-1



FG-12UX-1

GLOBAL SPECIFICATIONS

Model	Collet Size		Free Speed min ⁻¹	Power		Overall Length		Weight		Max. Air Consumption		Air Hose Size	
	mm	in		W	hp	mm	in	kg	lb	m ³ /min	ft ³ /min	mm	in
FG-12U-1	6	-	43,000	130	0.177	188	7.4	0.6	1.3	0.3	10.6	6.3	1/4
FG-12U-2	3	-	43,000	130	0.177	190	7.48	0.6	1.3	0.3	10.6	6.3	1/4
FG-12UX-1	6	-	43,000	130	0.177	213	8.39	0.7	1.5	0.3	10.6	6.3	1/4
FG-12UX-2	6	-	43,000	130	0.177	211	8.3	0.7	1.5	0.3	10.6	6.3	1/4

TOOL SELECTION GUIDE

STANDARD MODELS

Model	Roll Throttle (-2)		Lever (-1)		Locking Lever (F)	
	Side exhaust (-)	Rear exhaust (X)	Side exhaust (-)	Rear exhaust (X)	Side exhaust (-)	Rear exhaust (X)
	3 mm	6 mm	6 mm	6 mm	6 mm	6 mm
FG-12U-2	541 207 1410	541 205 2700				
FG-12U-1			541 205 2691		541 205 2696	
FG-12UX		541 205 2710		541 205 2704		541 205 2708

CE certified models

Model	Roll Throttle (-2)	Lever (-1)	Locking Lever (F)	
	Rear exhaust (X)	Side exhaust (-)	Side exhaust (-)	Rear exhaust (X)
	6 mm	6 mm	6 mm	6 mm
FG-12U-1		541 207 1402	541 207 1405	
FG-12UX-1				541 207 1414
FG-12UX-2	541 207 1418			

For CE region availability of non CE models, please inquire to your Fuji representative.

NPT models

Model	Lever (-1)	Locking Lever (F)	
	Rear exhaust (X)	Side exhaust (-)	Rear exhaust (X)
	1/4"	6 mm	1/4"
FG-12U-1		541 207 1406	
FG-12UX-1	541 205 2703		541 205 2707

For possibility of NPT inlet for other models, please inquire to your Fuji representative.

Model	Roll Throttle (-2)		Lever (-1)		Locking Lever (F)	
	Side exhaust (-)	Rear exhaust (X)	Side exhaust (-)	Rear exhaust (X)	Side exhaust (-)	Rear exhaust (X)
	Collet Size	6 mm	6 mm	6 mm	6 mm	6 mm
FG-12U-2 3	541 207 1410 (3mm)					
FG-12U-2 6	541 205 2700 (6mm)					
FG-12U-1			541 205 2691		541 205 2696	
FG-12UX		541 205 2710		541 205 2704		541 205 2708

DIE GRINDERS

FG-13 SERIES

FG-13 series feature compact and sturdy design with 30,000 rpm of speed. They are widely used for grinding and deburring with mounted points or carbide burrs.

MAX. DIAMETER OF ABRASIVES

Please use correct diameter of mounted points and carbide burrs for the speed

Mounted Point		Burr Head	
mm	in	mm	in
13	1/2	10	3/8



MAIN FEATURES

- Compact and sturdy body design
- Light weight



GLOBAL SPECIFICATIONS

Model	Collet Size		Free Speed min ⁻¹	Power		Overall Length		Weight		Max. Air Consumption		Air Hose Size	
	mm	in		W	hp	mm	in	kg	lb	m ³ /min	ft ³ /min	mm	in
FG-13-1	3	1/8	30,000	140	0.188	158	6.22	0.37	0.82	0.25	8.83	6.3	1/4
FG-13-10	3	1/8	30,000	140	0.188	158	6.22	0.37	0.82	0.25	8.83	6.3	1/4
FG-13X-1	3	1/8	30,000	140	0.188	183	7.2	0.4	0.9	0.25	8.83	6.3	1/4
FG-13X-10	3	1/8	30,000	140	0.188	183	7.2	0.4	0.9	0.21	7.4	6.3	1/4
FG-13-2	3	1/8	30,000	140	0.188	150	5.91	0.45	0.99	0.25	8.83	6.3	1/4
FG-13X-2	3	1/8	30,000	140	0.188	179	7.05	0.5	1.1	0.21	7.4	6.3	1/4
FG-13-1F	3	1/8	30,000	140	0.188	158	6.22	0.37	0.82	0.25	8.83	6.3	1/4
FG-13X-1F	3	-	30,000	140	0.188	183	7.2	0.4	0.9	0.25	8.83	6.3	1/4

TOOL SELECTION GUIDE

STANDARD MODELS

Model	Roll Throttle		Lever		Locking Lever (F)	
	Side exhaust (-)	Rear exhaust (X)	Side exhaust (-)	Rear exhaust (X)	Side exhaust (-)	Rear exhaust (X)
	3 mm	3 mm	3 mm	3 mm	3 mm	3 mm
FG-13-2	541 205 2727					
FG-13-20	541 205 2730					
FG-13-1			541 205 2712		541 205 2717	
FG-13-10			541 205 2721		541 205 2724	
FG-13X-2		541 205 2745				
FG-13X-20		541 205 2748				
FG-13X-1				541 205 2733		541 205 2736
FG-13X-10	541 205 2740					541 205 2742

Long bearing cover version (-1 and -2) available for harder grinding



Short bearing cover (-10 and -20) helps grinding in tight spots



CE certified models

Model	Roll Throttle		Locking Lever (F)		
	Side exhaust (-)		Side exhaust (-)		Rear exhaust (X)
	3 mm	1/8"	3 mm	1/8"	3 mm
FG-13-2	541 207 1426	541 207 1423			
FG-13-20		541 207 1427			
FG-13-1			541 207 1422		
FG-13-10			541 207 1421	541 207 1420	
FG-13X-1			541 207 1432		541 207 1431

For CE region availability of non CE models, please inquire to your Fuji representative.

NPT models

Model	Roll Throttle			Locking Lever (F)	
	Side exhaust (-)		Rear exhaust (X)	Side exhaust (-)	Rear exhaust (X)
	3 mm	1/8"	1/8"	1/8"	1/8"
FG-13-2	541 207 1424	541 205 2729			
FG-13-20	541 207 1428	541 205 2732			
FG-13-10				541 205 2726	
FG-13-1				541 205 2720	
FG-13X-10					541 205 2744
FG-13X-1					541 205 2739
FG-13X-20			541 205 2750		

For possibility of NPT inlet for other models, please inquire to your Fuji representative.

FG-26H SERIES

The FG-26H series features a high accuracy collet and spindle design to provide best in class run-out characteristics and low vibration, increasing life of abrasive. Suitable for both mounted point and carbide burr work. Extended models are also available for hard to reach applications

MAX. DIAMETER OF ABRASIVES

Please use correct diameter of mounted points and carbide burrs for the speed

Mounted Point		Burr Head	
mm	in	mm	in
25	1	13	1/2

COLLET BUSH (OPTION FOR 6MM COLLETS)



Please use it as an adapter when using 3 mm diameter mounted points

MAIN FEATURES

- High accuracy collet and spindle
- Low vibration
- Compact body and light weight



REAR EXHAUST MODEL (WITH HOSE)



GLOBAL SPECIFICATIONS

Model	Collet Size		Free Speed min ⁻¹	Power		Overall Length		Weight		Max. Air Consumption		Air Hose Size	
	mm	in		W	hp	mm	in	kg	lb	m ³ /min	ft ³ /min	mm	in
FG-26H-1	6	1/4	24,000	240	0.322	161	6.34	0.5	1.1	0.5	17.7	9.5	3/8
FG-26H-2	6	-	24,000	240	0.322	152	5.98	0.52	1.15	0.52	18.4	9.5	3/8
FG-26H-2N	6	-	24,000	240	0.322	152	5.98	0.52	1.15	0.52	18.4	9.5	3/8
FG-26HX-2	6	-	24,000	240	0.322	188	7.4	0.53	1.17	0.5	17.7	9.5	3/8
FG-26H-1F	6	-	24,000	240	0.322	161	6.34	0.5	1.1	0.5	17.7	9.5	3/8
FG-26HX-1F	6	-	24,000	240	0.322	188	7.4	0.53	1.17	0.5	17.7	9.5	3/8
FG-26HL-2	6	1/4	24,000	240	0.322	263	10.35	0.67	1.48	0.5	17.7	9.5	3/8
FG-26HL-2N	6	-	24,000	240	0.322	273	10.7	0.72	1.6	0.5	14.1	9.5	3/8
FG-26HL-1F	6	1/4	24,000	220	0.3	283	11.1	0.65	1.4	0.5	14.1	9.5	3/8

TOOL SELECTION GUIDE

STANDARD MODELS

Model	Roll Throttle				Lever		Locking Lever (F)					
	Front exhaust (FE)	Side exhaust (-)		Rear exhaust (X)	Front exhaust (FE)	Side exhaust (-)	Front exhaust (FE)		Side exhaust (-)		Rear exhaust (X)	
	6 mm	6 mm	1/4"	6 mm	6 mm	6 mm	6 mm	1/4"	6 mm	1/4"	6 mm	
FG-26H-2	541 206 0688	541 206 0686										
FG-26H-2N	541 206 0692	541 206 0690										
FG-26H-1					541 206 0709	541 206 0707	541 210 2809	541 210 2810	541 210 2807			
FG-26HX-1												541 210 2985
FG-26HX-2				541 210 2906								
FG-26HL-1F							541 210 2423		541 210 2422	541 210 2424		
FG-26HL-2	541 210 2416	541 210 2415	541 210 2417									
FG-26HL-2N	541 210 2421	541 210 2420										

CE certified models

Model	Roll Throttle		Locking Lever (F)				
	Side Exhaust (-)		Front exhaust (FE)		Side exhaust (-)		Rear exhaust (X)
	6 mm	1/4"	6 mm	1/4"	6 mm	1/4"	6 mm
FG-26H-1F			541 210 3000	541 210 3001	541 210 2998	541 210 2999	
FG-26HX-1F							541 210 3009 541 210 3010
FG-26HL-2	541 210 3156	541 210 3157					
FG-26HL-1F				541 210 3158	541 210 3159		

For CE region availability of non CE models, please inquire to your Fuji representative.

NPT models

Model	Roll Throttle	Lever	Locking Lever (F)	
	Side exhaust (-)	Rear exhaust (X)	Side Exhaust (-)	Rear exhaust (X)
	1/4"	1/4"	1/4"	1/4"
FG-26H-2	541 210 2899			
FG-26HX-1		541 210 2984		541 210 2986
FG-26HL-2	541 210 2418			
FG-26HL-1F			541 210 2425	

For possibility of NPT inlet for other models, please inquire to your Fuji representative.

DIE GRINDERS

FG-50H SERIES

The FG-50H series features a high accuracy collet and spindle design to provide best in class run-out characteristics and low vibration, increasing life of abrasive. The higher power makes the tools especially suitable for carbide burr applications.

MAX. DIAMETER OF ABRASIVES

Please use correct diameter of mounted points and carbide burrs for the speed

Mounted Point		Burr Head	
mm	in	mm	in
32	1 1/4	22	7/8

MAIN FEATURES

- High accuracy collet and spindle
- Low noise and vibration
- Compact but sturdy body and light weight
- Suitable for carbide burr applications

COLLET BUSH (OPTION FOR 6MM COLLETS)

Ø3 —  — Ø6

Please use it as an adapter when using 3 mm diameter mounted points

REAR EXHAUST MODEL (WITH HOSE)



GLOBAL SPECIFICATIONS

Model	Collet Size		Free Speed min ⁻¹	Power		Overall Length		Weight		Max. Air Consumption		Air Hose Size	
	mm	in		W	hp	mm	in	kg	lb	m ³ /min	ft ³ /min	mm	in
FG-50H-1	6	-	18,000	340	0.456	187	7.4	0.7	1.5	0.43	15.2	9.5	3/8
FG-50HX-1F	6	1/4	18,000	340	0.456	210	8.3	0.7	1.5	0.43	15.2	9.5	3/8
FG-50H-2	6	1/4	18,000	340	0.456	176	6.7	0.8	1.8	0.43	15.2	9.5	3/8
FG-50H-2N	6	-	18,000	340	0.456	185	7.3	0.8	1.8	0.43	15.2	9.5	3/8
FG-50HX-2	6	-	18,000	340	0.456	214	8.4	0.9	1.9	0.43	15.2	9.5	3/8
FG-50H-3 6 FE	6	-	15,000	340	0.456	176	6.7	0.8	1.8	0.43	15.2	9.5	3/8

TOOL SELECTION GUIDE

STANDARD MODELS

Model	Roll Throttle			Lever		Locking Lever (F)		
	Front exhaust (FE)	Side exhaust (-)		Rear exhaust (X)	Side exhaust (-)	Rear exhaust (X)	Side exhaust (-)	Rear exhaust (X)
	6 mm	6 mm	1/4"	6 mm	6 mm	6 mm	6 mm	1/4"
FG-50H-1					541 210 3211		541 210 3213	
FG-50HX-1						541 210 3216		541 210 3217 541 210 3218
FG-50H-2	541 210 3203	541 210 3202	541 210 3204					
FG-50HX-2				541 210 3220				
FG-50H-2N	541 210 3210	541 210 3209						
FG-50H-3	541 210 4427							

CE certified models

Model	Locking Lever (F)		
	Side exhaust (-)	Rear exhaust (X)	
	6 mm	6 mm	1/4"
FG-50H-1	541 210 3227		
FG-50HX-1		541 210 3229	541 210 3230

For CE region availability of non CE models, please inquire to your Fuji representative.

NPT models

Model	Roll Throttle	Locking Lever (F)			
	Side exhaust (-)	Side exhaust (-)		Rear exhaust (X)	
	1/4"	6 mm	1/4"	6 mm	1/4"
FG-50H-2	541 210 3205				
FG-50H-1		541 210 3214	541 210 3215		
FG-50HX-1				541 210 3228	541 210 3219

For possibility of NPT inlet for other models, please inquire to your Fuji representative.

LOW SPEED GRINDERS

These powerful Grinders are designed with a gear reduction mechanism and speed control governor to maintain the power and rotational speed. Their light weight and compact design make them excellent for polishing, grinding, paint removal and can be used with non-woven cloth, brushes, flap wheels and buffs.

GRINDING WHEEL MODELS FOR TYPE 1



FG-3H-6



FG-4VA-1, 2



FG-3VX-2F, 3F

GLOBAL SPECIFICATIONS

Model	Max Dia. (wheel size)		Exhaust	Free Speed	Power		Spindle	Overall Length		Weight		Max. Air Consumption		Air Hose Size	
	mm	in			min ⁻¹	W		hp	mm	in	kg	lb	m ³ /min	ft ³ /min	mm
FG-3VX-3F	125 x 19 x 9.5	5 x 3/4 x 3/8	—	7600	279	0.4	W3/8-16	316	12.4	1.4	3.08	0.47	16.60	9.5	3/8
FG-3VX-2F	75 x 19 x 9.5	3 x 3/4 x 3/8	—	9500	294	0.4	W3/8-16	316	12.4	1.4	3.08	0.47	16.60	9.5	3/8
FG-3H-6	65 x 25 x 9.53	2-1/2 x 1 x 3/8	Side exhaust	9700	520	0.7	W3/8-16	329	13	1.5	3.3	0.55	19.40	9.5	3/8
FG-4VA-1	75 x 13 x 9.53	3 x 1/2 x 3/8	Side exhaust	7500	470	0.6	W3/8-16	385	15.2	2.3	5.07	0.90	31.80	12.7	1/2
FG-4VA-2	100 x 19 x 12.7	4 x 3/4 x 1/2	Side exhaust	6300	470	0.6	W1/2-12	391	15.4	2.3	5.07	0.90	31.80	12.7	1/2

TOOL SELECTION GUIDE

STANDARD MODELS

Model	Side exhaust (-)	Rear exhaust (X)
	Roll Throttle	Locking Lever
FG-4VA-1	541 205 2861	
FG-4VA-2	541 205 2862	
FG-3H-6	541 205 2833	
FG-3VX-3F		541 205 2844
FG-3VX-2F		541 205 2842

CE certified models

Model	Rear exhaust (X)
	Locking Lever
FG-3VX-3F	541 207 1534
FG-3VX-2F	541 207 1533

For CE region availability of non CE models, please inquire to your Fuji representative.

COLLET MODELS

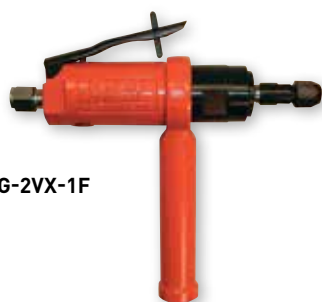

FG-2VX-1F



FG-3VX-1F, 6F

GLOBAL SPECIFICATIONS

Model	Collet Size		Exhaust	Free Speed	Power		Spindle	Overall Length		Weight		Max. Air Consumption		Air Hose Size	
	mm	in			min ⁻¹	W		hp	mm	in	kg	lb	m ³ /min	ft ³ /min	mm
FG-2VX-1F	6	1/4	—	4300	350	0.258	3/8-24UNF	216	8.5	0.9	1.98	0.34	12	9.5	3/8
FG-3VX-1F	6	-	—	7600	279	0.4	W3/8-16	331	13	1.4	3.08	0.45	15.90	9.5	3/8
FG-3VX-6F	6	-	—	12000	294	0.4	W3/8-16	331	13	1.4	3.08	0.47	16.60	9.5	3/8

TOOL SELECTION GUIDE

STANDARD MODELS

Model	Locking Lever
	6 mm
FG-2VX-1F	541 205 2753
FG-3VX-1F	541 205 2841
FG-3VX-6F	541 205 2848

CE certified models

Model	Locking Lever	
	6 mm	1/4"
FG-2VX-1F	541 207 1503	541 207 1502
FG-3VX-1F	541 207 1532	
FG-3VX-6F	541 207 1536	

For CE region availability of non CE models, please inquire to your Fuji representative.

NPT models

Model	Locking Lever
	6 mm
FG-2VX-1F	541 205 2752

For possibility of NPT inlet for other models, please inquire to your Fuji representative.

STRAIGHT GRINDERS

All Fuji grinders are designed and produced using Fuji's latest grinder technology. Fuji straight grinders are equipped with centrifugal speed control governors, noise reducing design. These standard features assure high performance and smooth operation.

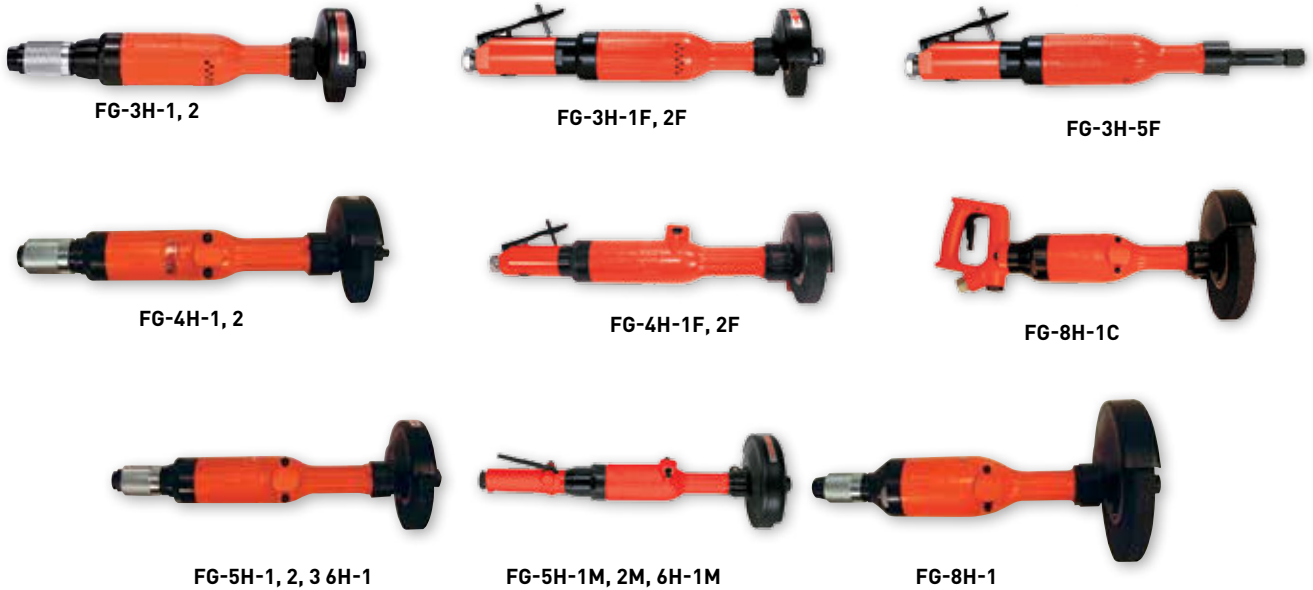

GLOBAL SPECIFICATIONS

Model	Max. Dia. (Grinding Wheel)		Collet Size		Exhaust	Free Speed min ⁻¹	Power		Spindle	Overall Length		Weight		Max. Air Consumption		Air Hose Size	
	mm	in	mm	in			W	hp		mm	in	kg	lb	m ³ /min	ft ³ /min	mm	in
FG-3H-1	65 x 13 x 9.53	2-1/2 x 1/2 x 3/8	-	-	Side exhaust	14600	520	0.7	W3/8-16	317	12.5	1.5	3.31	0.55	19.40	9.5	3/8
FG-3H-1F	65 x 13 x 9.53	2-1/2 x 1/2 x 3/8	-	-	Side exhaust	14600	520	0.7	W3/8-16	342	13.5	1.7	3.7	0.55	19.40	9.5	3/8
FG-3H-2	75 x 13 x 9.53	3 x 1/2 x 3/8	-	-	Side exhaust	12700	520	0.7	W3/8-16	317	12.5	1.5	3.3	0.55	19.40	9.5	3/8
FG-3H-2F	75 x 13 x 9.53	3 x 1/2 x 3/8	-	-	Side exhaust	12700	520	0.7	W3/8-16	342	13.5	1.7	3.75	0.55	19.40	9.5	3/8
FG-4H-1	100 x 19 x 9.53	4 x 3/4 x 3/8	-	-	Side exhaust	9500	690	0.9	W3/8-16	385	15.2	2.1	4.63	0.80	28.30	12.7	1/2
FG-4H-1F	100 x 19 x 9.53	4 x 3/4 x 3/8	-	-	Side exhaust	9500	690	0.9	W3/8-16	408	16.1	2.3	5.1	0.80	28.30	12.7	3/8
FG-4H-2	100 x 19 x 12.7	4 x 3/4 x 1/2	-	-	Side exhaust	9500	690	0.9	W1/2-12	391	15.4	2.1	4.63	0.80	28.30	12.7	1/2
FG-4H-2F	100 x 19 x 12.7	4 x 3/4 x 1/2	-	-	Side exhaust	9500	690	0.9	W1/2-12	414	16.3	2.3	5.07	0.80	28.30	12.7	1/2
FG-5H-1	125 x 19 x 12.7	5 x 3/4 x 1/2	-	-	Side exhaust	7600	960	1.3	W1/2-12	405	15.9	2.7	5.95	1.00	35.30	12.7	1/2
FG-5H-1M	125 x 19 x 12.7	5 x 3/4 x 1/2	-	-	Side exhaust	7600	960	1.3	W1/2-12	506	19.9	2.5	5.5	1.00	35.30	12.7	1/2
FG-5H-2	125 x 19 x 15.8	5 x 3/4 x 5/8	-	-	Side exhaust	7600	960	1.3	5/8-11 UNC	410	16.1	2.76	6.09	1.00	35.30	12.7	1/2
FG-5H-2M	125 x 19 x 15.8	5 x 3/4 x 5/8	-	-	Side exhaust	7600	960	1.3	5/8-11 UNF	511	20.1	2.5	5.5	1.00	35.30	12.7	1/2
FG-8H-1C	205 x 25 x 15.8	8 x 1 x 5/8	-	-	Side exhaust	4600	1471	2	5/8-11 UNF	538	21.2	5.6	12.3	1.60	56.50	12.7	1/2
FG-8H-2	180 x 25 x 15.8	7 x 1 x 5/8	-	-	Side exhaust	5300	1618	2.2	5/8-11 UNF	472	18.6	5.3	11.9	1.80	63.50	12.7	1/2
FG-8H-2M	180 x 25 x 15.8	7 x 1 x 5/8	-	-	Side exhaust	5300	1618	2.2	5/8-11 UNF	556	21.9	5.4	12.1	1.80	63.50	12.7	1/2
FG-5H-3	150 x 25 x 15.8	6 x 1 x 5/8	-	-	Side exhaust	6300	960	1.3	5/8-11 UNF	421	16.6	2.8	6.16	0.90	31.80	12.7	1/2
FG-6H-1M	150 x 25 x 15.8	6 x 1 x 5/8	-	-	Side exhaust	6300	1040	1.4	5/8-11 UNC	531	20.9	3.4	7.5	1.20	42.40	12.7	1/2
FG-3H-5	-	-	6	1/4	Side exhaust	14600	520	0.7	3/8-24UNF	342	13.5	1.26	2.78	0.55	19.40	9.5	3/8
FG-3H-5F	-	-	6	1/4	Side exhaust	14600	520	0.7	3/8-24UNF	367	14.4	1.46	3.22	0.55	19.40	9.5	3/8

TOOL SELECTION GUIDE

STANDARD MODELS

Model	Throttle	
	Roll Throttle	Locking Lever (F or M)
FG-3H-1	541 205 2818	541 205 2821
FG-3H-2	541 205 2823	541 205 2825
FG-4H-1	541 205 2849	541 205 2851
FG-4H-2	541 205 2853	541 205 2855
FG-5H-1	541 205 2864	541 205 2866
FG-5H-2	541 205 2868	541 205 2870
FG-5H-3	541 207 1604	
FG-6H-1	541 207 1623	541 207 1625
FG-8H-1	541 205 2944	
FG-8H-1C		541 205 2946
FG-8H-2	541 205 2950	541 205 2951
FG-3H-5	541 205 2828	

CE certified models

Model	Throttle
	Locking Lever (F or M)
FG-3H-1F	541 207 1511
FG-3H-2F	541 207 1512
FG-4H-1F	541 207 1538
FG-4H-2F	541 207 1539
FG-5H-1M	541 207 1600
FG-5H-2M	541 207 1602
FG-6H-1M	541 207 1626
FG-8H-1M	541 207 1631
FG-8H-2M	541 207 1633
FG-3H-5F (6 mm)	541 207 1519
FG-3H-5F (1/4")	541 207 1518

For CE region availability of non CE models, please inquire to your Fuji representative.

NPT models

Model	Throttle	
	Roll Throttle	Locking Lever (F or M)
FG-3H-1 N	541 205 2819	541 205 2820
FG-3H-2F N		541 205 2826
FG-4H-1 N	541 205 2850	
FG-4H-2F N		541 205 2856
FG-5H-1M N		541 205 2867
FG-5H-2M N		541 205 2871
FG-6H-1 N	541 205 2940	541 207 1627
FG-8H-1M N		541 207 1632
FG-3H-5 (1/4")	541 205 2827	541 205 2831

For possibility of NPT inlet for other models - Please inquire to your Fuji representative.

GRINDING WHEEL MODELS FOR TYPE 1



FG-50L-1



FG-50Y-1



FG-3HL-1



FG-3HY-1



FG-4HL-1



FG-5HL-1~13

GLOBAL SPECIFICATIONS

Model	Max Dia. (wheel Size)		Exhaust	Free Speed	Power		Spindle	Overall Length		Weight		Max. Air Consumption		Air Hose Size	
	mm	in			min ⁻¹	W		hp	mm	in	kg	lb	m ³ /min	ft ³ /min	mm
FG-50L-1	50 x 13 x 9.53	2 x 1/2 x 3/8	Side exhaust	18000	294	0.4	W3/8-16	307	12.1	1.4	3.08	0.43	15.20	9.5	3/8
FG-50L-1BF	50 x 13 x 9.53	2 x 1/2 x 3/8	Side exhaust	18000	294	0.4	W3/8-16	316	12.4	1.4	3.08	0.43	15.20	9.5	3/8
FG-50Y-1	50 x 13 x 9.53	2 x 1/2 x 3/8	Side exhaust	18000	294	0.4	W3/8-16	523	20.6	2	4.4	0.43	15.20	9.5	3/8
FG-50Y-1BF	50 x 13 x 9.53	2 x 1/2 x 3/8	Side exhaust	18000	294	0.4	W3/8-16	532	20.9	2	4.4	0.43	15.20	9.5	3/8
FG-3HL-1	65 x 13 x 9.53	2-1/2 x 1/2 x 3/8	Side exhaust	12000	520	0.7	W3/8-16	522	20.6	1.8	3.97	0.55	19.40	9.5	3/8
FG-3HL-1F	65 x 13 x 9.53	2-1/2 x 1/2 x 3/8	Side exhaust	12000	520	0.7	W3/8-16	547	21.5	1.9	4.2	0.55	19.40	9.5	3/8
FG-3HY-1	65 x 13 x 9.53	2-1/2 x 1/2 x 3/8	Side exhaust	12000	520	0.7	W3/8-16	702	27.6	2.3	5.1	0.55	19.40	9.5	3/8
FG-4HL-1	75 x 19 x 9.53	3 x 3/4 x 3/8	Side exhaust	12000	690	0.9	W3/8-16	585	23	2.7	5.95	0.80	28.30	12.7	1/2
FG-4HL-1F	75 x 19 x 9.53	3 x 3/4 x 3/8	Side exhaust	12000	690	0.9	W3/8-16	615	24.2	2.6	5.7	0.80	28.30	12.7	1/2
FG-5HL-1	75 x 19 x 12.7	3 x 3/4 x 1/2	Side exhaust	12000	960	1.3	W1/2-12	953	37.5	5.3	11.6	1.00	35.30	12.7	1/2
FG-5HL-2	100 x 19 x 12.7	4 x 3/4 x 1/2	Side exhaust	9000	960	1.3	W1/2-12	953	37.5	5.3	11.7	1.00	35.30	12.7	1/2
FG-5HL-2M	100 x 19 x 12.7	4 x 3/4 x 1/2	Side exhaust	9000	960	1.3	W1/2-12	1050	41.3	5.4	11.9	1.00	35.30	12.7	1/2
FG-5HL-11	75 x 19 x 9.53	3 x 3/4 x 3/8	Side exhaust	12000	960	1.3	W3/8-16	599	23.6	3.3	7.26	1.00	35.30	12.7	1/2
FG-5HL-13	100 x 16 x 12.7	4 x 5/8 x 1/2	Side exhaust	9000	960	1.3	W3/8-16	599	23.6	3.3	7.26	1.00	35.30	12.7	1/2

TOOL SELECTION GUIDE

STANDARD MODELS

Model	Throttle	
	Roll Throttle	Locking Lever (BF or M)
FG-50L-1 E	541 205 2924	541 205 2926
FG-50Y-1 E	541 205 2937	541 205 2939
FG-3HL-1	541 205 2834	541 205 2836
FG-3HY-1	541 205 2838	
FG-4HL-1	541 205 2857	541 205 2859
FG-5HL-1	541 205 2872	
FG-5HL-2	541 205 2874	541 205 2876
FG-5HL-11	541 207 1605	
FG-5HL-13	541 207 1607	

CE certified models

Model	Throttle
	Locking Lever (BF or M)
FG-3HL-1F	541 207 1527
FG-4HL-1F	541 207 1544
FG-50L-1BF	541 207 1586
FG-50Y-1BF	541 207 1596
FG-5HL-2M	541 207 1612

For CE region availability of non CE models, please inquire to your Fuji representative.

NPT models

Model	Throttle	
	Roll Throttle	Locking Lever (BF or M)
FG-50L-1BF		541 205 2925
FG-50Y-1BF		541 205 2938
FG-3HL-1	541 205 2835	541 205 2837
FG-4HL-1	541 205 2858	541 205 2860
FG-5HL-2M		541 207 1613

For possibility of NPT inlet for other models, please inquire to your Fuji representative.

EXTENDED GRINDERS

ROLL THROTTLE MODELS FOR INNER GRINDING



FG-50L-1A



FG-50Y-1A



FG-3HL-1A



FG-3HY-1A



FG-4HL-1A



FG-5HL-1A-13A

GLOBAL SPECIFICATIONS

Model	Part Number	Max. Dia. (Grinding Wheel)		Free Speed min ⁻¹	Spindle in	Power		Overall Length		Weight		Max. Air Consumption		Air Hose Size	
		mm	in			W	hp	mm	in	kg	lb	m ³ /min	ft ³ /min	mm	in
FG-5HL-11A	541 207 1606	75 x 19 x 9.53	3 x 3/4 x 3/8	12000	W3/8-16	960	1.3	599	23.6	3	6.6	1.00	35.30	12.7	1/2
FG-5HL-13A	541 207 1608	100 x 16 x 12.7	4 x 5/8 x 1/2	9000	W3/8-16	960	1.3	599	23.6	3	6.6	1.00	35.30	12.7	1/2
FG-5HL-1A	541 207 1610	75 x 19 x 12.7	3 x 3/4 x 1/2	12000	W1/2-12	960	1.3	953	37.5	5	11	1.00	35.30	12.7	1/2
FG-5HL-2A	541 207 1611	100 x 19 x 12.7	4 x 3/4 x 1/2	9000	W1/2-12	960	1.3	953	37.5	5	11	1.00	35.30	12.7	1/2
FG-4HL-1A	541 207 1543	75 x 19 x 9.53	3 x 3/4 x 3/8	12000	W3/8-16	690	0.9	585	23	2.5	5.51	0.80	28.30	12.7	1/2
FG-3HL-1A	541 207 1526	65 x 13 x 9.53	2-1/2 x 1/2 x 3/8	12000	W3/8-16	520	0.7	522	20.6	1.8	3.97	0.55	19.40	9.5	3/8
FG-3HY-1A	541 207 1529	65 x 13 x 9.53	2-1/2 x 1/2 x 3/8	12000	W3/8-16	520	0.7	702	27.6	2.2	4.84	0.55	19.40	9.5	3/8
FG-50L-1A	541 207 1584	50 x 13 x 9.53	2 x 1/2 x 3/8	18000	W3/8-16	294	0.4	307	12.1	1.3	2.86	0.43	15.20	9.5	3/8
FG-50Y-1A	541 207 1594	50 x 13 x 9.53	2 x 1/2 x 3/8	18000	W3/8-16	294	0.4	523	20.6	1.9	4.18	0.43	15.20	9.5	3/8

Air Inlet Thread Size: PT 3/8" except FG-50L-1A, FG-50Y-1A: 1/4"



2" ANGLE GRINDERS COLLET MODELS

FA-2C series are featured with a compact body and sturdy structure. The series is a defact standard of small grinding. There are collet models FA-2C-2 & 30 and 2" grinding wheel models FA-2C-1

MAX. DIAMETER OF ABRASIVES

Please use correct diameter of mounted points and carbide burrs for the speed

Mounted Point		Burr Head	
mm	in	mm	in
32	1 1/4	22	7/8



FA-2C-30



FA-2C-30F



FA-2CX-30F

GLOBAL SPECIFICATIONS

Model	Collet Size		Free Speed min ⁻¹	Power		Spindle	Overall Length		Weight		Max. Air Consumption		Air Hose Size	
	mm	in		W	hp		mm	in	kg	lb	m ³ /min	ft ³ /min	mm	in
FA-2C-2	6	-	15,000	265	0.36	3/8-24UNF	157	6.20	0.6	1.3	0.4	14.12	9.5	3/8
FA-2C-2BF	6	-	15,000	265	0.36	3/8-24UNF	188	7.40	0.7	1.5	0.4	14.12	9.5	3/8
FA-2CX-2	6	-	15,000	265	0.36	3/8-24UNF	197	7.80	0.7	1.5	0.4	14.12	9.5	3/8
FA-2CX-2BF	6	-	15,000	265	0.36	3/8-24UNF	226	8.90	1	2.2	0.4	14.12	9.5	3/8
FA-2C-30	6	-	15,000	265	0.36	M8	157	6.20	0.6	1.4	0.4	14.12	9.5	3/8
FA-2C-30F	6	-	15,000	245	0.33	M8	188	7.40	0.7	1.5	0.4	14.12	9.5	3/8
FA-2CX-30	6	-	15,000	245	0.33	M8	197	0.80	0.8	1.7	0.4	14.12	9.5	3/8
FA-2CX-30F	6	-	15,000	245	0.33	M8	188	7.40	0.8	1.7	0.4	14.12	9.5	3/8

TOOL SELECTION GUIDE

STANDARD MODELS

Model	Roll Throttle				Locking Lever (BF or F)			
	Side exhaust (-)		Rear exhaust (X)		Side exhaust (-)		Rear exhaust (X)	
	6 mm	1/4"	6 mm	1/4"	6 mm	1/4"	6 mm	1/4"
FA-2C-2	541 205 2250	541 205 2251						
FA-2C-2BF						541 207 1080		
FA-2CX-2			541 205 2270					
FA-2CX-2BF							541 207 1093	541 205 2274
FA-2C-30	541 210 3160				541 210 3534			
FA-2CX-30 6	541 210 3536				541 210 3537			

CE certified models

Model	Locking Lever (BF or F)			
	Side exhaust (-)		Rear exhaust (X)	
	6 mm	1/4"	6 mm	1/4"
FA-2C-2BF	541 207 1082	541 207 1081		
FA-2CX-2BF			541 207 1095	541 207 1094
FA-2C-30F	541 210 3535			
FA-2CX-30F			541 210 3538	

For CE region availability of non CE models, please inquire to your Fuji representative.

NPT models

Model	Roll Throttle		Locking Lever (BF or F)	
	Side exhaust (-)			
	6 mm	1/4"	1/4"	1/4"
FA-2C-2		541 205 2249		
FA-2C-2BF			541 205 2253	
FA-2C-30	541 210 3533			
FA-2CX-2BF				541 205 2272

For possibility of NPT inlet for other models, please inquire to your Fuji representative.

ANGLE GRINDERS

2" ANGLE GRINDERS - GRINDING WHEEL MODELS

MAX. DIAMETER OF GRINDING WHEELS - TYPE 27

Please use correct diameter of grinding wheels for the speed

Grinding Wheel	
mm	in
50	2



FA-2C-1



FA-2CX-1



FA-2CX-1BF

GLOBAL SPECIFICATIONS

Model	Max Dia. (wheel Size)		Free Speed min ⁻¹	Power		Spindle	Overall Length		Weight		Max. Air Consumption		Air Hose Size	
	mm	in		W	hp		mm	in	kg	lb	m ³ /min	ft ³ /min	mm	in
FA-2C-1	50 x 4 x 9.5	2 x 5/32 x 3/8	15,000	265	0.36	1/4-28UNF	157	6.20	0.6	1.3	0.4	14.12	9.5	3/8
FA-2C-1BF	50 x 4 x 9.5	2 x 5/32 x 3/8	15,000	265	0.36	1/4-28UNF	188	7.40	0.7	1.5	0.4	14.12	9.5	3/8
FA-2CX-1	50 x 4 x 9.5	2 x 5/32 x 3/8	15,000	265	0.36	1/4-28UNF	197	7.80	0.7	1.5	0.4	14.12	9.5	3/8
FA-2CX-1BF	50 x 4 x 9.5	2 x 5/32 x 3/8	15,000	265	0.36	1/4-28UNF	226	8.90	1	2.2	0.4	14.12	9.5	3/8

TOOL SELECTION GUIDE

STANDARD MODELS

Model	Roll Throttle		Locking Lever (BF)	
	Side exhaust (-)	Rear exhaust (X)	Side exhaust (-)	Rear exhaust (X)
FA-2C-1	541 205 2244		541 205 2246	
FA-2CX-1		541 205 2265		541 205 2267

CE certified models

Model	Locking Lever (BF)	
	Side exhaust (-)	Rear exhaust (X)
FA-2C-1	541 207 1076	
FA-2CX-1		541 207 1091

For CE region availability of non CE models, please inquire to your Fuji representative.

NPT models

Model	Roll Throttle		Locking Lever (BF)	
	Side exhaust (-)	Rear exhaust (X)	Side exhaust (-)	Rear exhaust (X)
FA-2C-1	541 205 2245		541 205 2247	
FA-2CX-1		541 205 2266		541 205 2268

For possibility of NPT inlet for other models, please inquire to your Fuji representative.

4" ANGLE GRINDERS

There are three main ranges of 4" grinders, all designed for robustness and performance in demanding environments. The FA-30 features a small form factor and low weight. A versatile grinder that is very efficient for hard to access applications or non-horizontal work.

The FA-4C is air efficient and a great choice where there are limitations to air supply. Suitable for a variety of applications. The FA-40 features high power and is especially suitable for tough applications such as aluminum grinding but offers high removal rates over all areas.

Each series is available in a variety of handle configurations. The FA-30 also has rear exhaust versions.

MAX. DIAMETER AND HOLE SIZE OF GRINDING WHEELS - TYPE 27

Please use correct diameter of grinding wheels for the speed. Also select the correct hole size.

Grinding Wheel ϕ		Grinding Wheel Hole Size	
mm	in	mm	in
100	4	15	5/8 (15.8mm)



FA-30-2

**SMALL FORM FACTOR
LIGHT WEIGHT
490W/0.66HP - 1.2KG**



FA-4C-1

**AIR EFFICIENT WORKHORSE
550W/0.74HP - 1.8KG**



FA-40-1

**HIGH POWER
1000W/1.34HP - 1.9KG**



FA-3CK-2

**VERTICAL APPLICATION
SPECIALIST - 120° ANGLE
290W/0.4HP - 1.2KG**

GLOBAL SPECIFICATIONS

Model	Max Dia. (wheel Size)		Exhaust	Free Speed	Power		Spindle	Overall Length		Weight		Max. Air Consumption		Air Hose Size	
	mm	in			min ⁻¹	W		hp	mm	in	kg	lb	m ³ /min	ft ³ /min	mm
FA-30-2	100 x 6 x 15	4 x 1/4 x 0.591	Side exhaust	13,500	490	0.66	M8	181	7.10	1.2	2.6	0.68	24	9.5	3/8
FA-30X-2	100 x 6 x 15	4 x 1/4 x 0.591	Rear exhaust	13,500	440	0.60	M8	209	8.20	1.2	2.6	0.68	24	9.5	3/8
FA-30X-2F	100 x 6 x 15.8	4 x 1/4 x 5/8	Rear exhaust	13,500	440	0.60	M8	219	8.60	1.2	2.6	0.68	24	9.5	3/8
FA-3CK-2	100 x 6 x 15	4 x 1/4 x 0.591	Side exhaust	13,500	290	0.39	M8	164	6.50	1.2	2.6	0.4	14.12	9.5	3/8
FA-40-1	100 x 6 x 15	4 x 1/4 x 0.591	Side exhaust	13,500	1000	1.34	M8	208	8.20	1.9	4.19	1	35.31	9.5	3/8
FA-40-1F	100 x 6 x 15.8	4 x 1/4 x 5/8	Side exhaust	13,500	1000	1.34	M8	247	9.70	1.9	4.19	1	35.31	9.5	3/8
FA-4C-1	100 x 6 x 15	4 x 1/4 x 0.591	Side exhaust	13,500	550	0.74	M8	210	8.30	1.8	3.97	0.55	19.42	9.5	3/8
FA-4C-1F	100 x 6 x 15.8	4 x 1/4 x 5/8	Side exhaust	13,500	550	0.74	M8	240	9.40	1.9	4.19	0.55	19.42	9.5	3/8
FA-4C-3	100 x 6 x 15	4 x 1/4 x 0.591	Side exhaust	13,500	550	0.74	M8	210	8.30	1.8	3.97	0.55	19.42	9.5	3/8

TOOL SELECTION GUIDE

STANDARD MODELS

Model	Roll Throttle				Locking Lever (F)	
	Wheel Hole Size				Wheel Hole Size	
	15 mm	15 mm Rear Exhaust	5/8"	5/8" Rear Exhaust	15 mm	5/8"
FA-30-2	541 210 3603		541 210 3604			541 210 4048
FA-30X-2		541 210 4050		541 210 4051		
FA-3CK-2	541 207 1111		541 205 2291			
FA-40-1	541 207 1118		541 207 1119		541 207 1120	
FA-4C-1	541 207 1122		541 205 2301		541 205 2304	
FA-4C-3	541 205 2307					

CE certified models

Model	Locking Lever (F)		
	Wheel Hole Size		
	15 mm	5/8"	5/8" Rear Exhaust
FA-30-2		541 210 4049	
FA-30X-2			541 210 4053
FA-40-1	541 210 3011		
FA-4C-1	541 207 1125		

For CE region availability of non CE models. Please inquire to your Fuji representative.

NPT models

Model	Roll Throttle		Locking Lever (F)		
	Wheel Hole Size		Wheel Hole Size		
	5/8"	5/8" Rear Exhaust	15 mm	5/8"	5/8" Rear Exhaust
FA-30-2				541 210 4316	
FA-30X-2		541 210 4317			541 210 4318
FA-40-1	541 210 2869		541 210 2870		
FA-4C-1	541 205 2302		541 205 2303		

For possibility of NPT inlet for other models, please inquire to your Fuji representative.

ANGLE GRINDERS

5" ANGLE GRINDERS

There are 2 ranges of 5" angle grinders, FA-5C (790W, 1.06hp) and FA-5E with higher power (956W, 1.28hp) and lower profile body. These models are available with variety of speed, spindle, and handle configurations.

MAX. DIAMETER AND HOLE SIZE OF GRINDING WHEELS - TYPE 27

Please use correct diameter of grinding wheels for the speed. Also select the correct hole size.

Grinding Wheel ϕ		Grinding Wheel Hole Size	
mm	in	mm	in
125	5	22	7/8 (22.2mm)



FA-5C-1



FA-5E-1V



FA-5E-13VF

GLOBAL SPECIFICATIONS

Model	Max Dia. (wheel Size)		Exhaust	Free Speed min ⁻¹	Power		Spindle	Overall Length		Weight		Max. Air Consumption		Air Hose Size	
	mm	in			W	hp		mm	in	kg	lb	m ³ /min	ft ³ /min	mm	in
FA-5C-1	125 x 6 x 22	5 x 1/4 x 0.866	Side exhaust	10,900	790	1.06	W1/2-16	226	8.90	2.33	5.14	0.8	28.25	9.5	3/8
FA-5C-4	125 x 6 x 22.2	5 x 1/4 x 7/8	Side exhaust	12,000	790	1.06	W1/2-16	226	8.90	2.33	5.14	0.8	28.25	9.5	3/8
FA-5C-4F	125 x 6 x 22.2	5 x 1/4 x 7/8	Side exhaust	12,000	790	1.06	W1/2-16	261	10.30	2.33	5.14	0.8	28.25	9.5	3/8
● FA-5E-1F	125 x 6 x 22.2	5 x 1/4 x 7/8	Side exhaust	10,900	956	1.28	M8	282	11.10	2.1	4.6	0.95	33.54	9.5	3/8
FA-5E-1V	125 x 6 x 22	5 x 1/4 x 0.866	Side exhaust	10,900	956	1.28	M8	225	8.90	2.05	4.52	0.95	33.54	9.5	3/8
FA-5E-1VF	125 x 6 x 22.2	5 x 1/4 x 7/8	Side exhaust	10,900	956	1.28	M8	262	10.30	1.9	4.1	0.95	33.54	9.5	3/8
● FA-5E-2F	125 x 6 x 22.2	5 x 1/4 x 7/8	Side exhaust	12,000	956	1.28	M8	282	11.10	2.1	4.63	0.95	33.54	9.5	3/8
FA-5E-2V	125 x 6 x 22.2	5 x 1/4 x 7/8	Side exhaust	12,000	956	1.28	M8	225	8.90	1.9	4.1	0.95	33.54	9.5	3/8
FA-5E-2VF	125 x 6 x 22.2	5 x 1/4 x 7/8	Side exhaust	12,000	956	1.28	M8	262	10.30	1.99	4.39	0.95	33.54	9.5	3/8
● FA-5E-13F	125 x 6 x 22.2	5 x 1/4 x 7/8	Side exhaust	12,000	956	1.28	3/8-24 UNF	282	11.10	2.2	4.8	0.95	33.54	9.5	3/8
FA-5E-13VF	125 x 6 x 22.2	5 x 1/4 x 7/8	Side exhaust	12,000	956	1.28	3/8-24 UNF	262	10.30	2.2	4.8	0.95	33.54	9.5	3/8
FA-5E-15VF	125 x 6 x 22.2	5 x 1/4 x 7/8	Side exhaust	13,000	956	1.28	5/8-11	262	10.30	2.2	4.8	0.95	33.54	9.5	3/8
FA-5E-16VF	125 x 6 x 22.2	5 x 1/4 x 7/8	Side exhaust	6,000	956	1.28	5/8-11	262	10.30	2.2	4.8	0.95	33.54	9.5	3/8

* Marked ● are furnished with vibration dampers in the housing and dead handle

TOOL SELECTION GUIDE

STANDARD MODELS

Model	Roll Throttle		Locking Lever (F)
	Wheel Hole Size		Wheel Hole Size
	22 mm	7/8"	7/8"
FA-5C-1	541 205 2315		
FA-5C-4		541 205 2316	541 207 1135
FA-5E-1			541 205 2318
FA-5E-1V	541 205 2320		541 205 2323
FA-5E-2V		541 205 2332	541 205 2335
FA-5E-13V			541 205 2328

CE certified models

Model	Locking Lever (F)
	Wheel Hole Size
	7/8"
FA-5E-13V	541 207 1141
FA-5E-1V	541 207 1144
FA-5E-2	541 207 1145
FA-5E-2V	541 207 1148

For CE region availability of non CE models. Please inquire to your Fuji representative.

NPT models

Model	Roll Throttle	Locking Lever (F)
	Wheel Hole Size	Wheel Hole Size
	7/8"	7/8"
FA-5C-4	541 207 1134	541 210 2611
FA-5E-13V		541 207 1142
FA-5E-15V		541 210 4273
FA-5E-16V		541 210 4278

For possibility of NPT inlet for other models, please inquire to your Fuji representative.

ANGLE GRINDERS

7" ANGLE GRINDERS

There are 3 ranges of 7" angle grinders, FA-7C with conventional specifications 1280W (1.72hp), and FA-7E with higher power 1500W, 2hp and lower profile body. FA-6C with conventional specification for compact 7" grinders

MAX. DIAMETER AND HOLE SIZE OF GRINDING WHEELS - TYPE 27

Please use correct diameter of grinding wheels for the speed. Also select the correct hole size.

Grinding Wheel ø		Grinding Wheel Hole Size	
mm	in	mm	in
180	7	22	7/8 (22.2mm)



FA-7C-1



FA-7E-3V



FA-7E-8VF



FA-6C-8M

GLOBAL SPECIFICATIONS

Model	Max Dia. (wheel Size)		Exhaust	Free Speed	Power		Spindle	Overall Length		Weight		Max. Air Consumption		Air Hose Size	
	mm	in			W	hp		mm	in	kg	lb	m³/min	ft³/min	mm	in
FA-5E-11V	180 x 6 x 22	7 x 1/4 x 0.866	Side exhaust	7,600	956	1.28	W1/2-16	214	8.40	2.25	4.96	0.95	33.54	9.5	3/8
FA-6C-1	180 x 6 x 22	7 x 1/4 x 0.866	Side exhaust	7,600	1180	1.58	W1/2-16	252	9.90	2.9	6.3	1.15	40.61	12.7	1/2
FA-6C-10	180 x 6 x 22.2	7 x 1/4 x 7/8	Side exhaust	7,000	1120	1.58	W1/2-16	252	9.90	2.9	6.3	1.15	40.61	12.7	1/2
FA-6C-12	180 x 6 x 22.2	7 x 1/4 x 7/8	Side exhaust	8,400	1180	1.58	W1/2-16	252	9.90	2.93	6.3	1.15	40.61	12.7	1/2
FA-6C-12M	180 x 6 x 22.2	7 x 1/4 x 7/8	Side exhaust	8,400	1180	1.58	W1/2-16	353	13.90	3	6.6	1.15	40.61	12.7	1/2
FA-6C-6M	180 x 6 x 22.2	7 x 1/4 x 7/8	Side exhaust	8,400	1180	1.58	5/8-11UNC	353	13.90	3	6.6	1.15	40.61	12.7	1/2
FA-6C-8M	180 x 6 x 22.2	7 x 1/4 x 7/8	Side exhaust	7,600	1180	1.58	5/8-11UNC	353	13.90	3	6.6	1.15	40.61	12.7	1/2
FA-6C-9M	180 x 6 x 22.2	7 x 1/4 x 7/8	Side exhaust	7,000	1180	1.58	5/8-11UNC	353	13.90	3	6.6	1.15	40.61	12.7	1/2
FA-7C-1	180 x 6 x 22	7 x 1/4 x 0.866	Side exhaust	7,600	1280	1.72	W1/2-16	264	10.40	3.4	7.5	1.4	49.43	12.7	1/2
FA-7C-3	180 x 6 x 22.2	7 x 1/4 x 7/8	Side exhaust	7,000	1280	1.72	5/8-11UNC	264	10.40	3.4	7.4	1.4	49.43	12.7	1/2
FA-7C-3M	180 x 6 x 22.2	7 x 1/4 x 7/8	Side exhaust	7,000	1280	1.72	5/8-11UNC	360	14.20	3.5	7.7	1.4	49.43	12.7	1/2
FA-7E-1V	180 x 6 x 22.2	7 x 1/4 x 7/8	Side exhaust	7,000	1500	2.01	W1/2-16	272	10.70	3.1	6.8	1.4	49.43	12.7	1/2
FA-7E-1VF	180 x 6 x 22.2	7 x 1/4 x 7/8	Side exhaust	7,000	1500	2.01	W1/2-16	307	12.10	3.1	6.8	1.4	49.43	12.7	1/2
FA-7E-2V	180 x 6 x 22	7 x 1/4 x 0.866	Side exhaust	7,600	1500	2.01	W1/2-16	272	10.70	3.1	6.8	1.4	49.43	12.7	1/2
FA-7E-3V	180 x 6 x 22.2	7 x 1/4 x 7/8	Side exhaust	8,400	1590	2.13	W1/2-16	272	10.70	3.1	6.84	1.4	49.43	12.7	1/2
FA-7E-5V	180 x 6 x 22.2	7 x 1/4 x 7/8	Side exhaust	7,000	1500	2.01	5/8-11 UNC	272	10.70	3.1	6.84	1.4	49.43	12.7	1/2
FA-7E-5VF	180 x 6 x 22.2	7 x 1/4 x 7/8	Side exhaust	7,000	1500	2.01	5/8-11 UNC	307	12.10	3.1	6.84	1.4	49.43	12.7	1/2
FA-7E-6VF	180 x 6 x 22.2	7 x 1/4 x 7/8	Side exhaust	7,600	1500	2.01	5/8-11 UNC	307	12.10	3.1	6.8	1.4	49.43	12.7	1/2
FA-7E-8VF	180 x 6 x 22.2	7 x 1/4 x 7/8	Side exhaust	8,400	1590	2.13	5/8-11 UNC	307	12.10	3.1	6.84	1.4	49.43	12.7	1/2
FA-7E-9VF	180 x 6 x 22.2	7 x 1/4 x 7/8	Side exhaust	8,400	1590	2.13	5/8-11 UNC	307	12.10	3.1	6.84	1.4	49.43	12.7	1/2

TOOL SELECTION GUIDE

For safety lever type tools - the FA-6C series comes equipped with a "M-type" handle and the FA-7C and FA-7E comes equipped with a "F-type" handle

STANDARD MODELS

Model	Roll Throttle		Locking Lever (M or F)
	Wheel Hole Size		Wheel Hole Size
	22 mm	7/8"	7/8"
FA-5E-11V	541 207 1137		
FA-6C-1	541 205 2344		
FA-6C-6			541 205 2358
FA-6C-8			541 205 2360
FA-6C-9			541 205 2362
FA-6C-10		541 205 2351	
FA-6C-12		541 205 2352	541 205 2355
FA-7C-1	541 207 1164		
FA-7E-1V		541 205 2368	541 207 7817
FA-7E-2V	541 205 2370		
FA-7E-3V		541 205 2372	
FA-7E-5V			541 205 2374
FA-7E-6V			541 205 2378
FA-7E-8V			541 205 2380

CE certified models

Model	Locking Lever (M or F)
	Wheel Hole Size
FA-6C-12	541 207 1155
FA-6C-6	541 207 1160
FA-6C-8	541 207 1162
FA-6C-9	541 207 1163
FA-7E-5V	541 207 1169
FA-7E-6V	541 207 1171
FA-7E-8V	541 207 1174
FA-7E-9V	541 207 1176

For CE region availability of non CE models, please inquire to your Fuji representative.

NPT models

Model	Roll Throttle		Locking Lever (M or F)
	Wheel Hole Size		Wheel Hole Size
	22 mm	7/8"	7/8"
FA-6C-1	541 205 2346		
FA-6C-12		541 205 2354	
FA-7C-3		541 210 3246	541 205 2365
FA-7E-5V		541 210 3163	541 205 2375
FA-7E-8V			541 205 2381

For possibility of NPT inlet for other models, please inquire to your Fuji representative.

ANGLE GRINDERS

9" ANGLE GRINDERS

MAX. DIAMETER AND HOLE SIZE OF GRINDING WHEELS - TYPE 27

Please use correct diameter of grinding wheels for the speed.

Grinding Wheel ø		Grinding Wheel Hole Size	
mm	in	mm	in
230	9	22	7/8 (22.2mm)



FA-9C-2



FA-9C-4M

GLOBAL SPECIFICATIONS

Model	Max Dia. (wheel Size)		Exhaust	Free Speed min ⁻¹	Power		Spindle	Overall Length		Weight		Max. Air Consumption		Air Hose Size	
	mm	in			W	hp		mm	in	kg	lb	m ³ /min	ft ³ /min	mm	in
FA-9C-2	230 x 9.5 x 22.2	9 x 3/8 x 7/8	Side exhaust	5,900	1620	2.17	W1/2-16	309	12.20	4.4	9.7	1.65	58.3	12.7	1/2
FA-9C-2M	230 x 9.5 x 22.2	9 x 3/8 x 7/8	Side exhaust	5,900	1620	2.17	W1/2-16	385	15.20	4.5	9.9	1.65	58.3	12.7	1/2
FA-9C-4	230 x 9.5 x 22.2	9 x 3/8 x 7/8	Side exhaust	5,900	1620	2.17	5/8-11 UNC	309	12.20	4.8	10.6	1.65	58.3	12.7	1/2
FA-9C-4M	230 x 9.5 x 22.2	9 x 3/8 x 7/8	Side exhaust	5,900	1620	2.17	5/8-11 UNC	385	15.20	4.8	10.6	1.65	58.3	12.7	1/2

TOOL SELECTION GUIDE

STANDARD MODELS

Model	Roll Throttle		Locking Lever (M or F)
	Wheel Hole Size		Wheel Hole Size
	22 mm	7/8"	7/8"
FA-9C-2		541 205 2382	541 205 2383
FA-9C-4	541 205 2384		541 205 2388

CE certified models

Model	Locking Lever (M or F)
	Wheel Hole Size
	7/8"
FA-9C-2M	541 207 1178
FA-9C-4M	541 207 1182

NPT models

Model	Roll Throttle		Locking Lever (M or F)	
	Wheel Hole Size		Wheel Hole Size	
	7/8"		22 mm	7/8"
FA-9C-4	541 205 2386			541 205 2387

For CE region availability of non CE models, please inquire to your Fuji representative.

For possibility of NPT inlet for other models, please inquire to your Fuji representative.

OTHER SIZE - GRINDING WHEELS OR CUTTING DISK



FA-5E-8V



FA-7C-21

MAIN FEATURES

- 1 model for type 27 grinding wheels, FA-6C-7 (6")
- 3 models for diamond cutters, FA-5E-8V (5"), FA-6C-20 (6"), FA-7C-21 (7") best for concrete cutting

GLOBAL SPECIFICATIONS

Model	Max ø (Wheel Size)		Exhaust	Free Speed min ⁻¹	Spindle	Power		Overall Length		Weight		Max. Air Consumption		Air Hose Size	
	mm	in				kw	hp	mm	in	kg	lb	m ³ /min	ft ³ /min	mm	in
FA-5E-8V	125 x 2 x 20	5 x 5/16 x 3/4	Side exhaust	10,900	M8	956	1.28	213	8.40	2.04	4.5	16	33.54	9.5	3/8
FA-6C-7	150 x 6 x 22	6 x 1/4 x 0.866	Side exhaust	9,100	W1/2-16	1180	1.58	252	9.90	2.7	5.9	19	40.61	12.7	1/2
FA-6C-20	150 x 2 x 20	7 x 5/16 x 3/4	Side exhaust	9,100	W1/2-16	1180	1.58	252	9.90	2.8	6.1	19	40.61	12.7	1/2
FA-7C-21	180 x 2 x 25.4	7 x 5/16 x 1	Side exhaust	7,600	W1/2-16	1280	1.72	264	10.40	3.4	7.4	23	49.43	12.7	1/2

TOOL SELECTION GUIDE

STANDARD MODELS

Model	Roll Throttle
FA-5E-8V	541 205 2343
FA-6C-7	541 207 1161
FA-6C-20	541 205 2357
FA-7C-21	541 205 2364

VERTICAL GRINDERS - VERTICAL SANDERS

VERTICAL GRINDERS STANDARD TYPE



FV-7-1M,4M



FV-9BH-1M

GLOBAL SPECIFICATIONS

Model	Max. Dia. (Grinding Wheel)		Free Speed	Height		Power		Overall Length		Weight		Max. Air Consumption		Air Hose Size	
	mm	in		mm	in	W	hp	mm	in	kg	lb	m ³ /min	ft ³ /min	mm	in
FV-7-1M	180 x 6 x 22	7 x 1/4 x 0.866	6,000	192	7.56	1410	1.89	247	9.70	4	8.8	1.4	49.43	12.7	1/2
FV-7-4M	180 x 6 x 22	7 x 1/4 x 0.866	8,400	192	7.56	1770	2.37	247	9.70	4	8.8	1.7	60.03	12.7	1/2
FV-9BH-1M	230 x 8 x 22	9 x 5/16 x 0.886	5,900	247	9.72	3320	4.45	279	11.00	5.8	12.79	2.8	98.87	19	3/4

Air Inlet Thread Size: PT 3/8", FV-9BH Series: PT 1/2".

TOOL SELECTION GUIDE

STANDARD MODELS

Model	Part Number
FV-7-1M	541 205 3516
FV-7-4M	541 205 3523
FV-9BH-1M	541 205 3526

CE certified models

Model	Part Number
FV-7-1M	541 207 2350
FV-7-4M	541 207 2355
FV-9BH-1M	541 207 2360

For CE region availability of non CE models, please inquire to your Fuji representative.

NPT models

Model	Part Number
FV-7-1M	541 205 3515
FV-7-4M	541 207 2356
FV-9BH-1M	541 205 3525

For possibility of NPT inlet for other models, please inquire to your Fuji representative.

VERTICAL GRINDERS CUP WHEEL TYPE



FV-9BH-4M

Height
(Height is a distance from wheel flange to top)

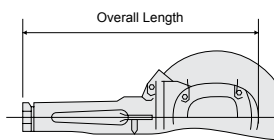
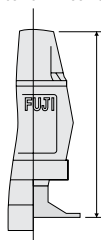

GLOBAL SPECIFICATIONS

Model	Max. Dia. (Grinding Wheel)		Free Speed	Height		Power		Overall Length		Weight		Max. Air Consumption		Air Hose Size	
	mm	in		mm	in	W	hp	mm	in	kg	lb	m ³ /min	ft ³ /min	mm	in
FV-9BH-4M	150 x 50 x 22.2	6 x 2 x 7/8	4,500	204	8.03	2900	3.89	278	11.00	6.1	13.4	2.4	84.7	19	3/4

Air Inlet Thread Size: PT 1/2".

TOOL SELECTION GUIDE

STANDARD MODELS

Model	Part Number
FV-9BH-4M	541 205 3529

CE certified models

Model	Part Number
FV-9BH-4M	541 207 2361

For CE region availability of non CE models, please inquire to your Fuji representative.

NPT models

Model	Part Number
FV-9BH-4M	541 205 3530

For possibility of NPT inlet for other models, please inquire to your Fuji representative.

SANDING DISC TYPE



FV-7-2M

Model	Max. Dia. (Grinding Wheel)		Free Speed	Height		Power		Overall Length		Weight		Max. Air Consumption		Air Hose Size	
	mm	in		mm	in	W	hp	mm	in	kg	lb	m ³ /min	ft ³ /min	mm	in
FV-7-2M	180 x 6 x 22	7 x 1/4 x 0.866	7,000	192	7.56	1580	2.12	247	9.70	4	8.8	1.6	56.5	12.7	1/2

Air Inlet Thread Size: PT 3/8".

TOOL SELECTION GUIDE

STANDARD MODELS

Model	Part Number
FV-7-2M	541 205 3520

CE certified models

Model	Part Number
FV-7-2M	541 207 2353

For CE region availability of non CE models, please inquire to your Fuji representative.

ANGLE SANDERS

ANGLE SANDERS - 3" TO 7"



FA-3CK-1
(120°)



FG-5PX-1



FA-150K-20
(120°)



FA-150KG-7
(120°)



FA-5E-6VF



FA-7E-5VF

GLOBAL SPECIFICATIONS

Model	Sanding Disc (Pad Size)		Free Speed min ⁻¹	Spindle	Power		Overall Length		Weight		Max. Air Consumption		Air Hose Size	
	mm	in			kw	hp	mm	in	kg	lb	m ³ /min	ft ³ /min	mm	in
FA-3CK-1	76 x 5.5 x 16	3 x 0.217 x 0.630	11,000	3/8-24UNF	290	0.4	164	6.50	1.1	2.4	0.4	14.1	9.5	3/8
FG-5PX-1	115 x 1.5 x 22	4-1/2 x 1/16 x 0.866	12,000	3/8-24UNF	370	0.5	170	6.69	1	2.2	0.5	17.7	9.5	3/8
FA-150K-20	127 x 14 x 22.2	5 x 0.551 x 7/8	8,400	W1/2-16(F)	900	1.2	210	8.27	1.7	3.7	1	35.3	12.7	1/2
FA-150K-20 BR	125 x - x 16 (brush)	5 x - x 5/8 (brush)	8,400	W1/2-16(F)	900	1.2	210	8.27	1.7	3.7	1	35.3	12.7	1/2
FA-150K-30	127 x 14 x 22.2	5 x 0.551 x 7/8	8,400	W1/2-16(F)	900	1.2	210	8.27	1.9	4.2	1	35.3	12.7	1/2
FA-150K-30 BR	125 x - x 16 (brush)	5 x - x 5/8 (brush)	8,400	W1/2-16(F)	900	1.2	210	8.27	1.9	4.2	1	35.3	12.7	1/2
FA-150KG-7	125 x - x 15.8 (brush)	5 x - x 5/8 (brush)	5,500	W1/2-16(F)	900	1.2	245	9.65	1.8	4	1.15	40.6	12.7	1/2
FA-5C-5	127 x 6 x 22.2	5 x 1/4 x 7/8	7,000	W1/2-16	670	0.9	226	8.90	2.1	4.6	0.58	20.5	9.5	3/8
FA-5E-6VF	180 x 12 x 22.2	7 x 0.472 x 7/8	6,000	3/8-24 UNF	956	1.3	262	10.30	1.8	4	0.95	33.5	9.5	3/8
FA-7E-5VF SD	180 x 7 x 22.2	7 x 0.276 x 7/8	7,000	5/8-11 UNC	1500	2.0	307	12.10	3.1	6.84	1.40	49.4	12.7	1/2
FA-7E-7VF	180 x 7 x 22.2	7 x 0.276 x 7/8	6,000	5/8-11 UNC	1500	2.0	307	12.10	3.1	6.8	1.40	49.4	12.7	1/2

TOOL SELECTION GUIDE

STANDARD MODELS

Model	Type	
	Sanding Pad	Brush (BR)
FG-5PX-1	541 205 2878	
FA-3CK-1	541 205 2289	
FA-5C-5	541 205 2317	
FA-150K-20	541 207 1068	541 207 1070
FA-150K-30	541 207 1072	541 207 1073
FA-150KG-7		541 205 2241
FA-7E-5VF SD	541 205 2377	
FA-7E-7VF	541 207 1172	

CE certified models

Model	Type
	Sanding Pad
FG-5PX-1	541 207 1614
FA-5E-6VF	541 207 1150
FA-7E-5VF	541 207 1170
FA-7E-7VF	541 207 1173

For CE region availability of non CE models, please inquire to your Fuji representative.

NPT models

Model	Type	
	Sanding Pad	Brush (BR)
FG-5PX-1	541 205 2879	
FA-150KG-7		541 205 2242
FA-5E-6VF	541 205 2340	

For possibility of NPT inlet for other models, please inquire to your Fuji representative.

BELT SANDERS

Fuji Belt Sanders are ideal for precise and efficient sanding of confined areas such as spherical surfaces and tubes which are difficult to access with conventional grinders. They are also the ideal tool for de-burring applications. 360 degree head rotation provides versatile solution for almost any application.



FBS-1-1,3



FBS-1-2,4

ANGLE ADJUSTMENT (UP TO 360 DEGREES)

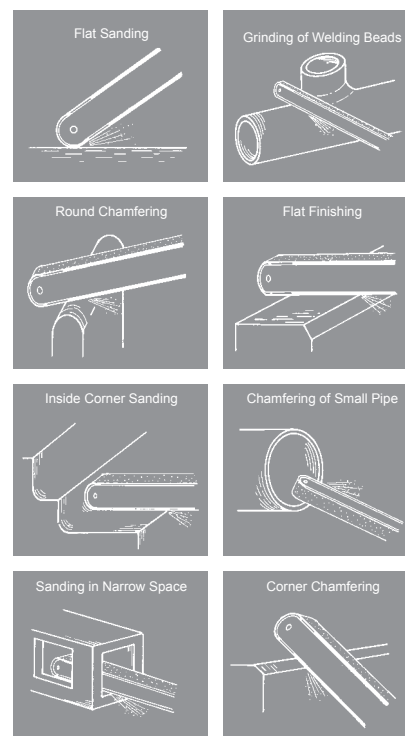

GLOBAL SPECIFICATIONS

Model	Belt Size		Free Speed min ⁻¹	Belt Speed rpm	Power		Overall Length		Weight		Max. Air Consumption		Air Hose Size	
	mm	in			kw	hp	mm	in	kg	lb	m ³ /min	ft ³ /min	mm	in
FBS-1-1	10 x 330	0.394 x 13.0	20,000	1200	280	0.37	281	11.10	1.1	2.4	0.57	20.1	9.5	3/8
FBS-1-2	20 x 520	0.512 x 20.5	20,000	1200	280	0.37	375	14.80	1.2	2.6	0.57	20.1	9.5	3/8
FBS-1-3	13 x 460	0.512 x 18.1	20,000	1200	280	0.37	345	13.58	1.2	2.6	0.57	20.1	9.5	3/8
FBS-1-4	20 x 460	0.787 x 18.1	20,000	1200	280	0.37	345	13.58	1.2	2.6	0.57	20.1	9.5	3/8

TOOL SELECTION GUIDE

STANDARD MODELS

Model	Part Number
FBS-1-1	541 205 2463
FBS-1-2	541 205 2465
FBS-1-3	541 205 2467
FBS-1-4	541 205 2470

CE certified models

Model	Part Number
FBS-1-1	541 207 1203
FBS-1-2	541 207 1204
FBS-1-3	541 207 1205
FBS-1-4	541 207 1207

For CE region availability of non CE models, please inquire to your Fuji representative.

NPT models

Model	Part Number
FBS-1-1	541 205 2464
FBS-1-2	541 205 2466
FBS-1-4	541 205 2469

For possibility of NPT inlet for other models, please inquire to your Fuji representative.

ACCESSORIES

SANDING BELTS



Sanding Belts in different size are able to be mounted to the tool by replacing Contact Arm Ass'y.

Applicable Model	Belt Size (mm)	Grit #40	Part Number #40	Grit #60	Part Number #60	Grit #80	Part Number #80	Grit #100	Part Number #100	Grit #120	Part Number #120
FBS-1-1	10 x 330	DSB-271	541 207 0843	DSB-273	541 205 2027	*DSB-274	541 205 2028	DSB-275	541 205 2029	DSB-276	541 205 2030
FBS-1-2	20 x 520	DSB-261	541 207 0842	DSB-263	541 205 2023	*DSB-264	541 205 2024	DSB-265	541 205 2025	DSB-266	541 205 2026
FBS-1-3	13 x 460	DSB-221	541 207 0833	DSB-223	541 207 0834	*DSB-224	541 207 0835	DSB-225	541 207 0836	DSB-226	541 205 2022
FBS-1-4	20 x 460	DSB-241	541 207 0837	DSB-243	541 207 0838	*DSB-244	541 207 0839	DSB-245	541 207 0840	DSB-246	541 207 0841

*Marked • are Standard Accessories.

CONTACT ARM ASSEMBLY

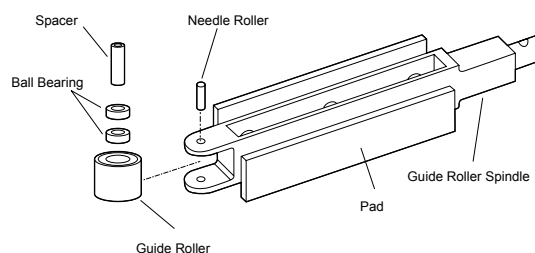

Contact Arm Ass'y	Size	Model	Part Number
FBS-1-1	10 x 330	DSB-271	541 205 6127
FBS-1-2	20 x 520	DSB-261	541 205 6128
FBS-1-3	13 x 460	DSB-221	541 205 6129
FBS-1-4	20 x 460	DSB-241	541 205 6130

ORBITAL SANDERS

Fuji Orbital Sanders are compact, lightweight & manoeuvrable, yet powerful enough for finishing lacquered and metal surfaces prior to re-painting. The effective dust extraction with rear exhaust helps keep the working environment clean.

Features

- Powerful sanding, high stability and low vibration.
- Excellent dust extraction ability to help keep the work area clean
- Available to suit variations of sandpapers; self-adhesive type, Velcro (Nylon Strip Fastener) Type and standard Clip-on Type.

DISC TYPE



DA-125C



FOR-125B, 150B



FOR-125BF, 150BF

GLOBAL SPECIFICATIONS

Model	Capacity (Sanding Disc)		Free Speed	Angle Head Height		Power		Overall Length		Weight		Max. Air Consumption		Air Hose Size	
	mm	in		mm	in	W	hp	mm	in	kg	lb	m ³ /min	ft ³ /min	mm	in
DA-125C	Φ 125	Φ 5	8,500	158	6.2	60	0.1	158	6.2	1.4	3	0.26	9.1	6.3	1/4
DA-125L	Φ 125	Φ 5	8,500	158	6.2	60	0.1	158	6.2	1.2	2.6	0.26	9.1	6.3	1/4
DA-125T	Φ 125	Φ 5	8,500	158	6.2	60	0.1	243	9.57	2	4.4	0.26	9.1	6.3	1/4
FOR-125B	Φ 125	Φ 5	8,000	122	4.8	120	0.16	243	9.6	2	4.4	0.36	12.7	6.3	1/4
FOR-125BF	Φ 125	Φ 5	8,500	124	4.9	120	0.16	243	9.57	2	4.4	0.36	12.7	6.3	1/4
FOR-150B	Φ 150	Φ 6	8,000	122	4.8	120	0.16	256	10.1	2.1	4.6	0.36	12.7	6.3	1/4
FOR-150BF	Φ 150	Φ 6	8,000	124	4.9	120	0.16	256	10.1	2.1	4.6	0.36	12.7	6.3	1/4

TOOL SELECTION GUIDE

STANDARD MODELS

Model	Paper Type	
	Adhesive Type (E)	Velcro Type (M)
DA-125L	541 205 1976	541 205 1977
DA-125C	541 205 1974	541 205 1975
DA-125T	541 205 1978	541 205 1979
FOR-125B	541 205 3061	541 205 3062
FOR-150B		541 205 3068
FOR-150BF	541 205 3069	541 205 3070

CE certified models

Model	Paper Type	
	Velcro Type (M)	
FOR-125BF	541 210 4095	

For CE region availability of non CE models, please inquire to your Fuji representative.

RECTANGLE SHEET TYPE

OB-75L, 90L



FOS-175B



RECTANGLE SHEET DIMENSION

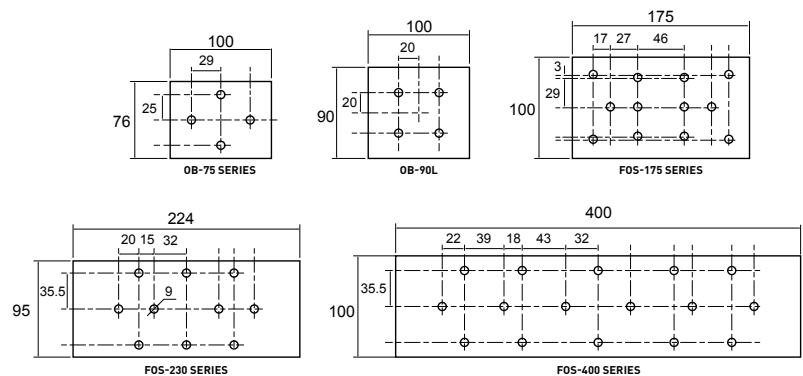

GLOBAL SPECIFICATIONS

Model	Capacity (Sanding Disc)		Free Speed	Angle Head Height		Power		Overall Length		Weight		Max. Air Consumption		Air Hose Size	
	mm	in		mm	in	W	hp	mm	in	kg	lb	m ³ /min	ft ³ /min	mm	in
OB-75L	75 x 100	3 x 4	7,000	145	5.7	60	0.1	145	5.7	1.2	2.6	0.26	9.1	6.3	1/4
FOS-175B	100 x 175	4 x 7	6,500	130	5.1	120	0.16	268	10.6	2.4	5.2	0.34	11.9	6.3	1/4
FOS-175BF	100 x 175	4 x 7	6,500	130	5.1	120	0.16	268	10.6	2.4	5.2	0.34	11.9	6.3	1/4
FOS-230B-E	100 x 230	4 x 9	6,000	132	5.2	120	0.16	291	11.5	2.6	5.7	0.34	11.9	6.3	1/4
FOS-230T-E	100 x 230	4 x 9	6,000	132	5.2	120	0.16	291	11.5	2.6	5.7	0.34	11.9	6.3	1/4

STANDARD MODELS

Model	Paper Type	
	Adhesive Type (E)	Velcro Type (M)
OB-75L	541 205 5315	541 205 5316
FOS-175B		541 205 3074
FOS-175T		541 205 3078
FOS-230B	541 205 3079	
FOS-230T	541 205 3081	

ACCESSORIES

ACCESSORIES PROVIDED



Model	Exhaust Hose	Dust Bag	Spanner	Punching Tool/Rod	Sanding Disc
FOR-125(T, B)	●	●	●	Rod	• 2pcs.
FOR-150(T, B)	●	●	●	Rod	• 2pcs.
OB-75(T, L)	●	●	-	●	-
OB-90L	●	●	-	-	-
FOS-175(T, B)	●	●	-	-	• 2pcs.
FOS-230(T, B)	●	●	-	●	• 2pcs.
FOS-400(T, B)	●	●	-	●	• 2pcs.

* ● = provided, - = not provided

HOLE PATTERN AND DIMENSIONS OF SANDING PAPERS AND PADS

DA-125,
FOR-125 SERIES

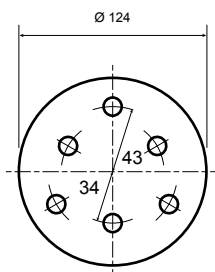

Disc Type

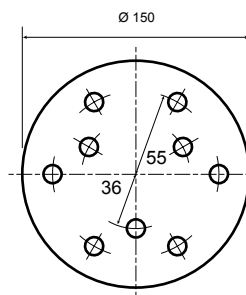

FOR-150 SERIES

Model	Adhesive Paper Type		Velcro Paper Type	
	Pad	Part Number	Pad	Part Number
DA-125	PAD-125E	541 207 5071	PAD-125M	541 207 5073
FOR-125	PAD-125E	541 207 5071	PAD-125M	541 207 5073
FOR-150	PAD-150E	541 207 5074	PAD-150M	541 207 5075

* Specify the grit when ordering sanding papers.

ABRASIVE TOOLS

ACCESSORIES

COLLET BUSHES

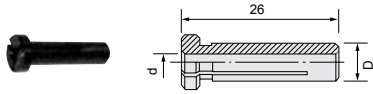

Item	Part Number	Size				Models
		D		d		
		mm	in	mm	in	
G-032347-00	541 205 3737	6.0	-	3.0	-	FG-26H, 26HX, 26HL, 50H, 50L, 50Y Series
G-032347-02	541 205 3738	6.0	-	-	1/8	FG-3H, 3HL, 4H, 4HL Series
G-032347-03	541 205 3739	-	1/4	-	1/8	FA-2C-2, FA-2CX-2, FA-2C-30, FA-2CX-30 Series

*These collet bushes are used for collet chucks.

COLLET CHUCKS

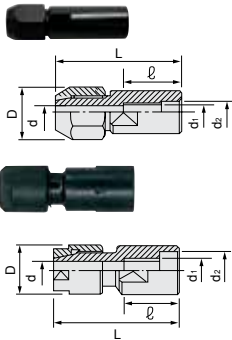

Collet		Collet nut		Size						Models			
Item	Part Number	Item	Part Number	d	d1	d2	D	L	e				
				mm	in	mm	in	mm	mm	mm			
G-101342-00	541 205 3819	G-162343-00	541 205 4103	6	-	3/8-24UNF	-	3/8	17Hex	57	32	FG-50L-2, 2BF, 50Y-2, 2BF, 3HL-2, 2F, FG-4HL-2, 2F, 3H-5, 5F	
G-041342-00	541 205 3745			-	1/4	-	-	-	-	-	-		-
G-017342-00	541 205 3716			6	-	W3/8-16	-	3/8	17Hex	57	32		FG-50L-1, 1BF, 50Y-1, 1BF, 3HL-1, 1F, 4HL-1, 1F, 4H-1, 1F, FG-3VX-1F, 2F, 3F, 6F, 3H-1, 1F, 2, 2F, 6, 4VA-1, 50DX-5F
G-017342-01	541 205 3717			-	1/4	-	-	-	-	-	-		
G-011342-00	541 205 3711	G-144343-00	541 205 3957	6	-	3/8-24UNF	-	3/8	17Hex	42	17	FG-2VX-1F,	
G-028342-00	541 205 3730			-	1/4	-	-	-	-	-	-	-	FA-2C-2, 2BF, 2CX-2, 2BF
A-122342-03	541 205 0648			6	-	M8	-	3/8	17Hex	42	17	14	44
G-220342-00	541 206 0626			-	1/4	-	-	-	-	-	-	-	
G-220342-01	541 206 0681			6	-	5/16-24UNF	12	-	16	44	21	FG-26H, 26HX, 26HL, 50H Series	
				-	1/4	-	-	-	-	-	-	-	

COLLET

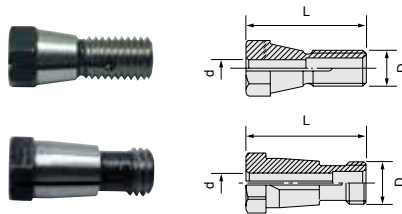

Collet / Chuck body		Collet nut		Size				Models	
Item N°	Part Number	Item N°	Part Number	d		D	Taper		
				mm	in	mm			
G-001342-01	541 205 3676	-	-	3.0	-	1/4-28UNF	3/10	20	TURBO-100
G-002342-00	541 205 3681	-	-	3.0	-	-	-	-	TURBO-100A
G-185342-00	541 205 4163	-	-	3.0	-	W11-24	2/5	23	FG-06-1, FG-13 series, 13X series
G-185342-01	541 205 4164	-	-	-	1/8	-	-	-	
G-221346-00	541 207 7908	G-221343-00	541 207 7907	3.0	-	1/4-28UNF	-	18	FG-06S-1
G-221346-01	541 210 2981			-	-	-	1/8	-	-

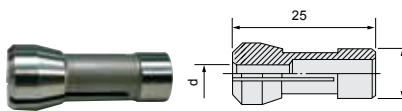

Item N°	Part Number	Size		Models
		d		
		mm	in	
G-028342-08	541 205 3734	3.0	-	FG-12U, 12UX
G-028342-04	541 205 3731	-	1/8	FG-25D, 25DX
G-028342-07	541 205 3733	6.0	-	FG-50D, 50DX
G-028342-06	541 205 3732	-	1/8	

CONE WHEEL

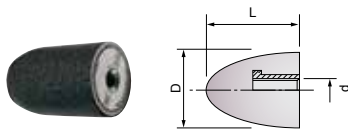

Item N°	Part Number	Size			Material
		D	L	d	
		mm	mm		
124	541 206 9006	38	65	W3/8-16	A-36P

ADAPTER FOR CONE WHEEL

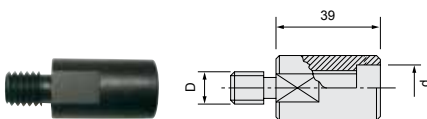

Item N°	Part Number	Size	
		D	d
		mm	mm
G-158309-00	541 205 4045	W3/8-16	5/16-24UNF

SPACER FOR CONE WHEEL

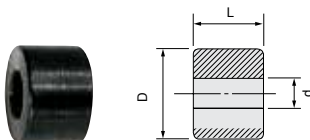

Item N°	Part Number	Size			
		d	D	L	
		mm	mm	mm	
G-013308-00	541 205 3714	9.53	3/8	20	13.5

CONE WHEEL APPLICATIONS

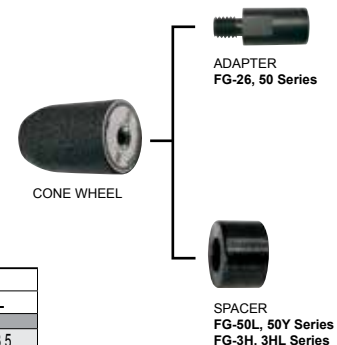

ACCESSORIES

TUNGSTEN CARBIDE BURRS

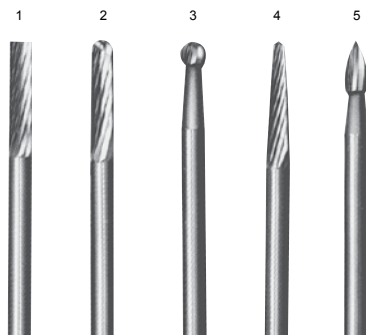

3mm Shank Dia

Index N°	AC Number	Part N°	Size		Model
			Head Dia mm	Length mm	
1	A03	541 206 0314	3	38	FG-06, FG-06S, TURBO-100, FG-13 series
2	B03	541 206 0315	3	38	
3	C03	541 206 0316	3	38	
4	E03	541 206 0317	3	38	
5	F03	541 206 0318	3	38	

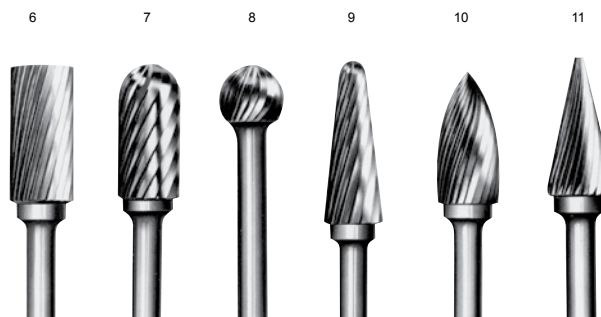

6mm Shank Dia

Index N°	AC Number	Part Number	Size		Model
			Head Dia mm	Length mm	
6	A08	541 206 0325	8	55	TURBO-100A, FG-12U, 13, 26H, 50H series
7	B08	541 206 0326	8	55	
8	C08	541 206 0327	8	55	
9	E08	541 206 0328	8	55	
10	F08	541 206 0329	8	55	
11	H08	541 206 0330	8	55	

MOUNTED WHEEL

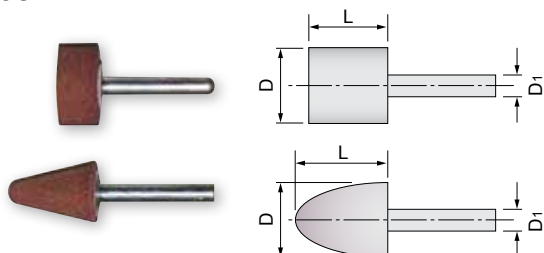

Type	AC Number	Part Number	Size			Material	Model
			D mm	L mm	D1 mm		
Straight	103	541 205 9459	10	10	3	WA-60	FG-12U, 13, 26H, 50H series
	105	541 205 9460	25	13	6		26H, 50H series
Cone	111	541 205 9459	10	16	3	WA-60	FG-13, 26H, 50H series

*Minimum order required : 100pcs. per item.

SHANK BRUSH

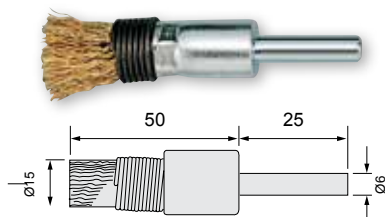

AC Number	Part Number	Free Speed	Model
		min ⁻¹	
170	541 206 0381	15,000	FG-3VX-6F, 3H-5 series FA-2C-2, 30 series

RADIAL WIRE BRUSHES

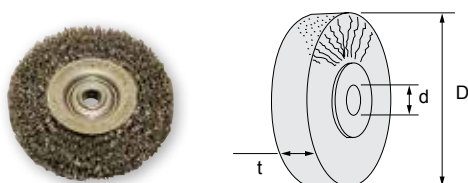

AC Number	Part Number	Size			Maximum Free Speed min ⁻¹	Model
		D mm	t mm	d mm		
181	541 205 9478	50	13	10	18,000	FG-50L, 50Y
182	541 205 9479	65	13	10	15,000	FG-3H-1, 1F, 3HL-1, 1F
183	541 205 9480	75	13	10	13,000	FG-3H-2, 2F, 4HL-1, 1F
184	541 205 9481	100	13	10	9,500	FG-4H-1, 1F
184-2	541 205 9565	100	13	13	9,500	FG-4H-2, 2F, 5HL-2, 2M
185	541 205 9482	125	19	16	7,600	FG-5H-2, 2M
185-2	541 205 9567	125	19	13	7,600	FG-5H-1, 1M

*Minimum order required : 10pcs. / item.

ABRASIVE TOOLS

ACCESSORIES

STRAIGHT GRINDING WHEELS FOR STRAIGHT AND EXTENSION GRINDERS

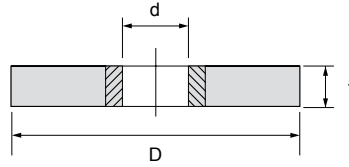

AC Number	Part Number	Size						Material	Maximum Free Speed min ⁻¹	Models
		D		t		d				
		mm	in	mm	in	mm	in			
*131	541 205 9463	50	2	13	1/2	9.53	3/8	A-36Q	18,000	FG-50L, -50Y Series
*132	541 205 9464	65	2 1/2	13	1/2	9.53	3/8	A-30R	14,000	FG-3H-1, 1F, 3HL-1, 1F, 2, 2F
*133	541 205 9465	75	3	13	1/2	9.53	3/8	A-24P	12,000	FG-3H-2, 2F, 4HL-1, 1F, 2, 2F
*133-1	541 205 9560	75	3	19	3/4	9.53	3/8	A-24P	12,000	FG-4HL-1, 1F, 2, 2F
*134	541 205 9466	100	4	19	3/4	9.53	3/8	A-24P	9,000	FG-4H-1, 1F
*136-2	541 205 9562	125	5	19	3/4	12.70	1/2	A-24P	7,600	FG-5H-1, 1M
*137	541 205 9468	125	5	19	3/4	15.88	5/8	A-24P	7,600	FG-5H-2, 2M
*138	541 205 9469	150	6	25	1	15.88	5/8	A-24P	6,300	FG-6H-1, 1M

* * = Minimum order required : 100pcs. / item, others = Minimum order required : 50pcs. / item.

ACCESSORIES FOR FA-2C, -2CX SERIES

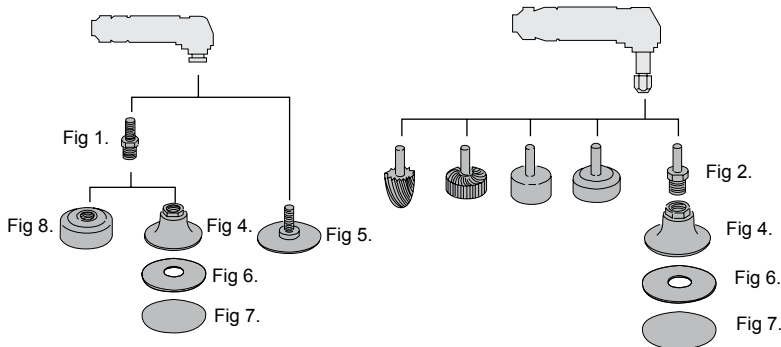

ATTACHMENTS

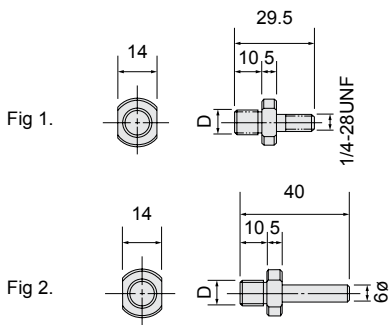

Item N°	Part Number	Size	Models
		D	
A-122693-01	541 205 0652	W3/8-16	FA-2C-1 series

AC Number	Part Number	Size	Models
		D	
A-122693-03	541 205 0654	W3/8-16	FA-2C-2, 30 series

ACCESSORIES

RUBBER BACKING PADS FIG 4.

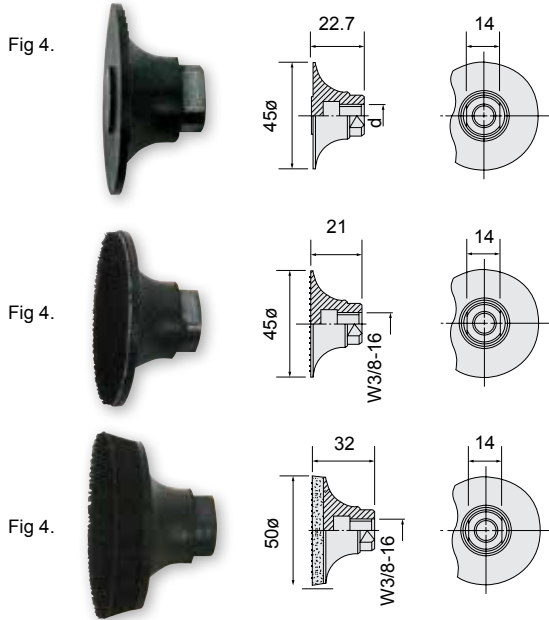

ADHESIVE TYPE

Item n°	Part Number	Size
		d
RP-2-2	541 205 5541	W3/8-16

VELCRO TYPE

Item n°	Part Number
MP-2-1	541 205 4843

VELCRO WITH SPONGE TYPE

Item n°	Part Number
MP-2-1S	541 205 4844

SANDING DISC

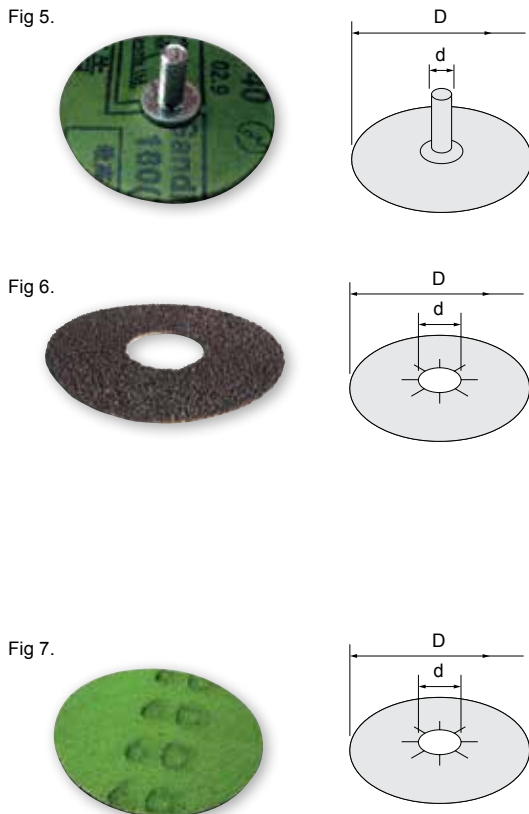

SHAFT TYPE

Item n°	Part Number	Size		Grit #	Models
		D	d		
		mm	mm		
MD-1	541 205 4837	50	1/4-28 UNF	40	FA-2C-1, 1BF FA-2CX-1, 1BF
MD-2	541 205 4838				
MD-3	541 205 4839				
MD-4	541 205 4840				
MD-5	541 205 4841				

*Minimum order required :50pcs. / item.

ADHESIVE TYPE

Item n°	Part Number	Size		Grit #	Models
		D	d		
		mm	mm		
DP-2-1	541 205 2015	50	16	40	FA-2C-2, 30 FA-2CX-2, 30 Series
DP-2-2	541 205 2016				
DP-2-3	541 205 2017				
DP-2-4	541 205 2018				
DP-2-5	541 205 2019				
DP-2-6	541 205 2020				
DP-2-7	541 207 0827				
DP-2-8	541 205 2021				
DP-2-9	541 207 0828				
DP-2-10	541 207 0826				

*Minimum order required : 100pcs. per item.

VELCRO TYPE

Item n°	Part Number	Size	Grit #	Models
		D		
		mm		
MP-2-10	541 207 4556	50	40	FA-2C-2, 30 FA-2CX-2, 30 Series
MP-2-2	541 205 4845			
MP-2-3	541 207 4557			
MP-2-4	541 205 4846			
MP-2-5	541 207 4558			
MP-2-6	541 205 4847			
MP-2-7	541 207 4559			
MP-2-8	541 205 4848			

*Minimum order required : 100pcs. per item.

ABRASIVE TOOLS

ACCESSORIES

SPACER

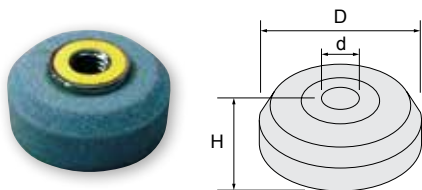

Item n°	Part Number	Size			Grit#	Models
		D mm	H mm	d mm		
MC-2-16	541 205 4836	40	18	W3/8-16	60	FA-2C-2, 2BF, 2CX-30, 30BF

*Minimum order required :10pcs. / item

RUBBER PAD AND WIRE BRUSH COMBINATION FOR ANGLE SANDERS

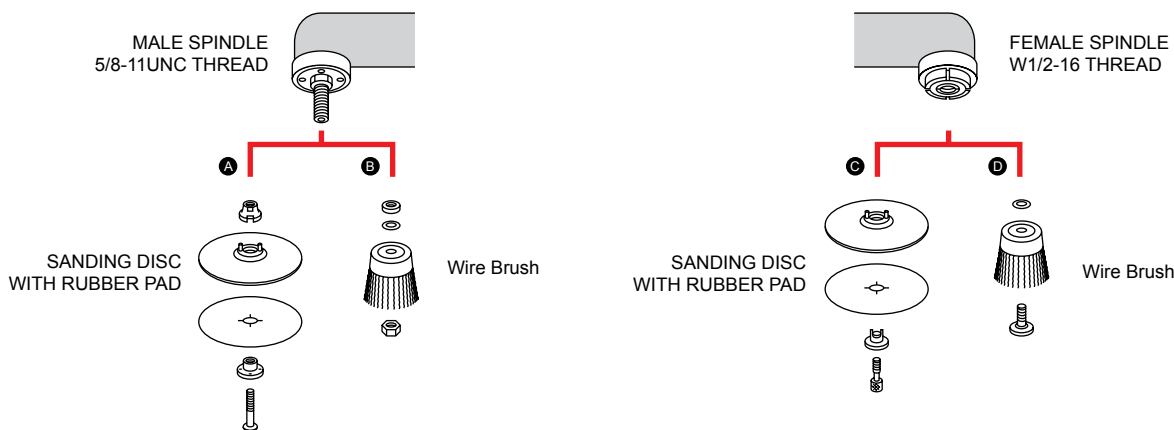

*Male Spindle 3/8-24UNF Thread type is applicable to A type **A**

RUBBER BACKING PADS FOR ANGLE AND VERTICAL SANDERS

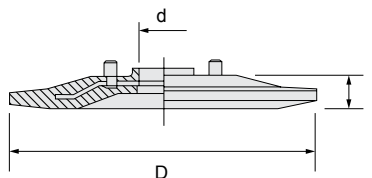

Item n°	Part Number	Size						Pin Space		Maximum Free Speed min ⁻¹	Models
		D		t		d		mm	in		
RP-2-2	541 205 5541	45	1 49/64	22.7	57/64	-	W3/8-16	"	"	15,000	FA-2C-1, 1BF, 2CX-1, 1BF *(A-122693-01) FA-2C-2, 2CX-2, 2C-30, 2CX-30 Series *(A-122693-03)
RP-3-2	541 205 5542	75	3	10.5	13/32	15.8	5/8			13,500	FA-3CK-1
RP-5-3	541 205 5545	125	5	17.0	43/64	22.2	7/8	44	1 47/64	8,500	FA-150K-2, 3
RP-5-5	541 205 5547	125	5	17.0	43/64	22.2	7/8	46	1 13/16	8,500	FA-5C-5, 150KG-7, 5E-7 Series
RP-5-6	541 205 5548	125	5	14.0	35/64	22.2	7/8	46	1 13/16	8,500	FA-5E-4 Series
RP-7	541 205 5550	180	7	15.0	19/32	22.2	7/8	46	1 13/16	7,000	FA-150KG-7, 5C-5, 6C-9, 10, FA-5E-6 Series, 5E-7V, 7E-1, 5 Series, FV-7-1M, 2M

DISC BACKING PADS FOR FG-5PX-1

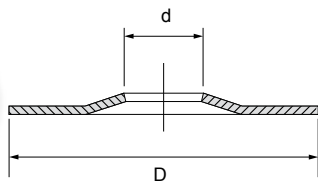

Item n°	Part Number	Size				Models
		D		d		
FP-3-1	541 205 3108	75	3	22.2	7/8	FG-5PX-1
FP-5-1	541 205 3110	125	5	22.2	7/8	

ACCESSORIES

BEVEL WIRE BRUSHES

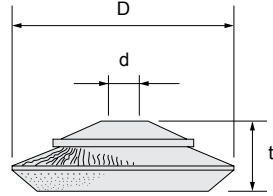

Item N°	Part Number	Size			Maximum Free Speed min ⁻¹	Models
		D	t	d		
195	541 205 9487	125	35	16	8,400	FA-150K-20, 30
195S	541 206 9611	125	35	16	8,400	

*S - Stainless Steel
*Minimum order required : 10pcs. / item.

CUP WIRE BRUSHES

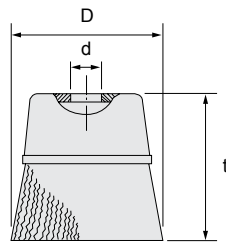

Item N°	Part Number	Size			Maximum Free Speed min ⁻¹	Models
		D	t	d		
192	541 205 9484	75	47	16	8,400	FA-150K-20, 30
193	541 205 9485	100	55	16	8,400	
192S	541 206 9610	75	47	16	7,000	FA-6C-9, 10, 9M, 5C-5
193S	541 205 9569	100	55	16	7,000	FA-6C-9, 10, 9M, 5C-5
194	541 205 9486	120	65	16	6,000	FA-150KG-7

*S - Stainless Steel
*Minimum order required : 10pcs. / item.

DEPRESSED CENTER GRINDING WHEELS

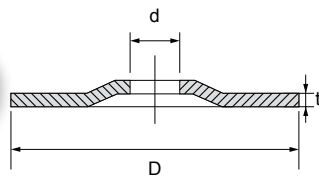

Item N°	Part Number	Size						Material	Maximum Free Speed min ⁻¹	Models
		D		t		d				
		mm	in	mm	in	mm	in			
161	541 205 8915	50	2	4	5/32	9.53	3/8	A-36P	15,000	FA-2C-1
161-1S	541 205 9563	50	2	2	5/64	9.53	3/8	A-46P		

*Minimum order required : 25pcs. / item.



DRILLS / TAPPERS

INSTRUCTIONS _____	72
DRILLS FEATURES _____	72
DRILLS / BABY ANGLE DRILLS / CORNER DRILLS ____	73
ACCESSORIES _____	78
TAPPERS FEATURES _____	79
TAPPERS _____	80

INSTRUCTIONS

DRILL SIZE, CUTTING SPEED AND MATERIAL

When selecting a suitable model of drill for your application, it should be chosen on the basis of drill bit size and suitable cutting speed for the material to be drilled. The table below shows the recommended drill bit sizes for different speeds when drilling some common materials. The figures in the table are based on drill speeds at normal pressure and the minimum torque in conjunction with drill breakthrough. The table only shows which drill bit sizes give the cutting speeds within the ranges stated. Note that it is quite possible to drill with smaller diameter drill bits, i.e. at lower cutting speeds.

In order to obtain a sufficient cutting force when applying feed pressure by hand, pre-drilling is recommended for drill bit sizes above 8 mm when drilling in mild steel, soft cast iron, malleable iron as well as for holes larger than 6 mm in forged steel and stainless steel.

Fuji Drills are light weight with a sturdy construction. Their practical design represents Fuji's latest developments in drills technology. Fuji offers a complete line of drills with a drilling capacity range from 2 mm to 100 mm.

Suggested Cutting Speed (min⁻¹) for Drilling

Material	Stainless Steel	Forged Steel	Mild Steel	Soft Cast Iron	Malleable Iron	Brass or Bronze	Aluminum	Magnesium	Plastic	Wood	Titanium
Drill bit size (mm)	9-12	12-15	24-33	30-45	24-27	60-90	60-90	75-120	30-45	90-120	15-18
3 mm	1100	1400	3000	4000	2700	8000	8000	10400	4000	11000	1750
4 mm	840	1100	2200	3000	2000	6000	6000	7800	3000	8400	1300
5 mm	660	860	1800	2400	1600	4800	4800	6200	2400	6700	1050
6 mm	550	700	1500	2000	1350	4000	4000	5200	2000	5600	880
8 mm	420	540	1100	1500	1000	3000	3000	3900	1500	4200	660
10 mm	330	430	900	1200	800	2400	2400	3100	1200	3300	630
12 mm	280	350	750	1000	700	2000	2000	2600	1000	2800	440
13 mm	260	330	700	920	630	1800	1800	2400	920	2550	400
14 mm	240	300	640	850	580	1700	1700	2200	850	2400	370
16 mm	210	270	560	750	500	1500	1500	1950	750	2100	330
19 mm	180	230	480	630	430	1250	1250	1600	630	1800	280
22 mm	150	200	410	540	370	1100	1100	1400	540	1500	240
23 mm	140	190	390	520	350	1000	1000	1350	520	1450	230
25 mm	130	170	360	480	320	960	960	1250	480	1330	210
28 mm	120	150	320	420	290	850	850	1100	420	1200	190
32 mm	100	130	280	380	250	750	750	980	380	1050	160
44 mm	75	100	210	270	180	550	550	700	270	750	120
50 mm	65	85	180	240	160	480	480	620	240	670	110
75 mm	44	57	120	160	110	320	320	420	160	450	70
100 mm	33	43	90	120	80	240	240	310	120	330	55

DRILLS FEATURES

REVERSIBLE



Fuji offer some reversible drills. The reverse action is selected by simply turning the reverse lever.



PLASTIC COVER

The plastic cover softens the effect of vibration during the drilling application and creates a "warm to touch" feeling to improve operator comfort.

TWO-STAGE THROTTLE ACTUATION



This mechanism allows slow start smooth operation to full speed allowing the drill bit to be centralised prior to drilling at full speed.



DEAD HANDLE

The dead handle helps to soften the breakthrough reaction force experienced when drilling "tough holes".



SWIVEL TYPE EXHAUST COVER

The exhaust cover can be rotated to enable the operator to choose a convenient direction of the exhaust air.



SELF-RETURN ROLL HANDLE

When the operator releases the handle, it automatically returns to the "OFF" position and the air supply is switched off. When ordering, add "S" to the end of the model name.



REAR EXHAUST WITH BUILT-IN MUFFLER

The noise level is minimised via the muffler built into the exhaust cover.



LOCKING HANDLE

The locking handle is designed to reduce the risk of inadvertent starting of the drill. The handle reverts automatically to the locked position when released.

JACOBS TAPERED MODELS WITH YUKIWA CHUCK

Fuji offer special models with Jacobs tapered spindles and chucks for very precise drilling application.

Especially FRD-6PH series provides run-out (0.02mm for FRD-6PH-2 & 3, 0.06mm for FRD-6PH-5 & 7) For more versatile applications the series provides 3/8"-24 spindles models (FRD-6PH TH).



FRD-6PH-3



Yukiwa tapered chucks



FRD-6PH-5

STRAIGHT TYPE

FRD-5S



FRD-6S



GLOBAL SPECIFICATIONS

Model		Drilling Capacity		Stall Torque		Free Speed	Type and Size of Spindle		Chuck Capacity	Side to Center		Power		Overall Length		Weight		Max. Air Consumption		Air Hose Size	
Thread Type	Taper Type	mm	in	N.m	ft.lb	min ⁻¹	Thread	Taper	mm	mm	in	W	hp	mm	in	kg	lb	m ³ /min	ft ³ /min	mm	in
FRD-5S-1		5	3/16	2	1.5	3200	3/8-24UNF		6.5	18.5	3/4	180	0.24	188	7.4	0.6	1.32	0.60	21.2	6.3	1/4
	FRD-5S-2T	5	3/16	0.3	0.2	24000		Jacobs Taper D	5	18.5	3/4	180	0.24	174	6.85	0.5	1.1	0.60	21.2	6.3	1/4
	FRD-6S-1T	3	1/8	0.6	0.44	21000		Jacobs Taper 1	6.5	21	17/20	290	0.39	177	6.97	0.7	1.52	0.54	19.2	9.5	3/8
FRD-6S-2		5	3/16	2.5	1.8	4300	3/8-24UNF		6.5	21	17/20	290	0.39	209	8.23	0.9	1.98	0.68	24	9.5	3/8
FRD-6S-3		8	5/16	2.9	2.1	2800	3/8-24UNF		8	21	17/20	290	0.39	218	8.56	1	2.21	0.68	24	9.5	3/8
FRD-6S-5		10	7/16	7	5.2	1300	3/8-24UNF		10	23	29/32	290	0.39	237	9.31	1.1	2.43	0.68	24	9.5	3/8
● FRD-6S-7		13	1/2	16	11.8	600	1/2-20UNF		13	21	17/20	290	0.39	271	10.7	1.7	3.75	0.68	24	9.5	3/8

* Marked ● are furnished with Dead Handle

TOOL SELECTION GUIDE

Standard models

Model	Throttle	
	Lever	Locking Lever (F)
FRD-5S-1 E	541 205 3306	541 207 2178
FRD-5S-2T	541 205 3310	
FRD-6S-1T	541 207 2214	
FRD-6S-2 E	541 205 3331	541 205 3332
FRD-6S-3 E	541 205 3337	541 205 3340
FRD-6S-5 E	541 205 3343	541 205 3346
FRD-6S-7 E	541 205 3348	541 205 3350

CE certified models

Model	Throttle	
	Locking Lever (F)	
FRD-5S-1F EC	541 207 2179	
FRD-6S-2F EC	541 207 2216	
FRD-6S-3F EC	541 207 2221	
FRD-6S-6F EC	541 207 2225	
FRD-6S-7F EC	541 207 2229	

For CE region availability of non CE models, please inquire to your Fuji representative.

NPT models

Model	Throttle	
	Lever	
FRD-5S-2T N	541 205 3311	
FRD-6S-3 N	541 205 3335	

For possibility of NPT inlet for other models, please inquire to your Fuji representative.

ACCESSORIES

DRILL CHUCKS



AC Number	Part Number	Models	Chuck Capacity	Type and Size of Spindle
DCK-5J	541 205 2006	FRD-5S-2T	5mm	J.T.#D
DCK-6.5	541 205 2007	FRD-5S-1 series, 5P-1 series, 6S-2 series, 6PH-2 series	6.5mm	3/8"-24 (Thread)
DCK-6.5J	541 205 2009	FRD-6PH-3 series	6.5mm	J.T.#1
DCK-8	541 205 2010	FRD-8PX-1 series	8mm	3/8"-24 (Thread)
DCK-8J	541 205 2011	FRD-6PH-3 series	8mm	J.T.#1
DCK-10	541 205 1997	FRD-8PX-2 series	10mm	3/8"-24 (Thread)
DCK-10J	541 205 2000	FRD-6PH-5 series	10mm	J.T.#2S
DCK-13	541 205 2001	FRD-8PX-3 series	13mm	1/2"-20 (Thread)
DCK-13J	541 205 2003	FRD-6PH-7 series	13mm	J.T.#6
DCK-16	541 205 2004	FRD-16Z series	16mm	5/8"-16 (Thread)

DRILLS

PISTOL/REAR EXHAUST TYPE



FRD-6PH-3



FRD-6PH-7



FRD-8PX

GLOBAL SPECIFICATIONS

Model		Drilling Capacity		Stall Torque		Free Speed		Type and Size of Spindle		Chuck Capacity		Side to Center		Power		Overall Length		Weight		Max. Air Consumption		Air Hose Size	
Thread Type	Taper Type	mm	in	N.m	ft.lb	min ⁻¹	Thread	Taper	mm	mm	in	W	hp	mm	in	kg	lb	m ³ /min	ft ³ /min	mm	in		
FRD-5P-1		5	3/16	2	1.5	3200	3/8-24UNF		6.5	18	18/25	180	0.24	155	6.1	0.6	1.32	0.40	14.1	6.3	1/4		
	FRD-6PX-1T	3	1/8	0.6	0.44	21000		Jacobs Taper 1	6.5	21	17/20	290	0.39	182	7.17	1	2.21	0.68	24	9.5	3/8		
FRD-6PH-2 TH	FRD-6PH-2	5	3/16	2.7	2	4300	3/8-24UNF	Jacobs Taper 1	6.5	21	0.85	340	0.46	198	7.8	0.9	1.98	0.58	20.6	9.5	3/8		
FRD-6PH-3 TH	FRD-6PH-3	6.5	1/4	4.3	3.2	2800	3/8-24UNF	Jacobs Taper 1	6.5	21	0.85	340	0.46	198	7.8	0.89	1.96	0.58	20.6	9.5	3/8		
FRD-6PH-3 8 TH	FRD-6PH-3 8	8	5/16	4.3	3.2	2800	3/8-24UNF	Jacobs Taper 1	8	21	0.85	340	0.46	198	7.8	0.89	1.96	0.58	20.6	9.5	3/8		
● FRD-6PH-5 TH	● FRD-6PH-5	10	7/16	7.5	5.5	1300	3/8-24UNF	Jacobs Taper 2S	10	21	0.85	320	0.43	243	9.54	1.4	3.09	0.58	20.6	9.5	3/8		
● FRD-6PH-7 TH	● FRD-6PH-7	13	1/2	15.8	11.7	600	1/2-20 UNF	Jacobs Taper 6	13	22.5	0.9	320	0.43	258	10.1	1.5	3.31	0.58	20.6	9.5	3/8		
FRD-8PX-1		8	5/16	5.9	4.4	2600	3/8-24UNF		8	25	1	440	0.59	198.5	7.81	1.7	3.75	0.76	26.8	9.5	3/8		
● FRD-8PX-2		10	7/16	12	8.9	1300	3/8-24UNF		10	26.5	1 1/10	440	0.59	220	8.64	2.1	4.63	0.76	26.8	9.5	3/8		
● FRD-8PX-3		13	1/2	20	14.8	900	1/2-20UNF		13	25.5	1	400	0.54	253.5	9.95	2.9	6.39	0.76	26.8	9.5	3/8		

* Marked ● are furnished with Dead Handle

TOOL SELECTION GUIDE

Standard models

Model	Jacobs Taper Models	Threaded Models (TH)	
		with chuck	without chuck (W/O C)
FRD-5P-1		541 205 3302	
FRD-6PX-1T	541 207 2192		
FRD-6PH-2	541 207 7834	541 210 4338	541 210 4359
FRD-6PH-3	541 207 2186	541 210 4341	541 210 4362
FRD-6PH-3 8	541 207 2187	541 210 4344	
FRD-6PH-5	541 207 2188	541 210 4347	541 210 4365
FRD-6PH-7	541 207 2190	541 210 4350	541 210 4368
FRD-8PX-1		541 205 3363	
FRD-8PX-2		541 205 3366	
FRD-8PX-3		541 205 3368	

CE certified models

Model	Jacobs Taper Models	Threaded Models (TH)	
		with chuck	without chuck (W/O C)
FRD-5P-1		541 207 2176	
FRD-6PH-2	541 210 3166	541 210 4339	541 210 4360
FRD-6PH-3 8		541 210 4345	
FRD-6PH-3	541 210 3169	541 210 4342	541 210 4363
FRD-6PH-5	541 210 3147	541 210 4348	541 210 4366
FRD-6PH-7	541 210 3170	541 210 4351	541 210 4369
FRD-8PX-1		541 207 2236	
FRD-8PX-2		541 207 2238	541 207 2239
FRD-8PX-3		541 207 2241	541 207 2242

For CE region availability of non CE models. Please inquire to your Fuji representative.

NPT models

Model	Jacobs Taper Models	Threaded Models (TH)	
		with chuck	without chuck (W/O C)
FRD-5P-1		541 205 3301	
FRD-6PH-2	541 210 2865	541 210 4340	541 210 4361
FRD-6PH-3 8	541 210 3221	541 210 4346	
FRD-6PH-3	541 207 8455	541 210 4343	541 210 4364
FRD-6PH-5	541 207 8454	541 210 4349	541 210 4367
FRD-6PH-7	541 207 8453	541 210 4352	541 210 4370
FRD-8PX-1		541 205 3361	
FRD-8PX-2		541 205 3364	
FRD-8PX-3		541 205 3367	

For possibility of NPT inlet for other models, please inquire to your Fuji representative.



GRIP HANDLE MEDIUM SIZE DRILLS



FRD-12Z-1~16Z-1
(OUTSIDE LEVER)



FRD-12Z-1C~16Z-1C
(INSIDE LEVER)

GLOBAL SPECIFICATIONS

Model	Drilling Capacity		Stall Torque		Free Speed	Type and Size of Spindle		Chuck Capacity	Side to Center		Power		Overall Length		Weight		Max. Air Consumption		Air Hose Size	
	mm	in	N.m	ft.lb	min ⁻¹	Thread	Taper	mm	mm	in	W	hp	mm	in	kg	lb	m ³ /min	ft ³ /min	mm	in
FRD-12Z-1	12	1/2	22	16.2	1200	1/2-20UNF	-	13	34	1 11/32	660	0.88	372	14.6	3.3	7.28	1.20	42.4	12.7	1/2
FRD-16Z-1	16	5/8	34.3	25.3	800	5/8-16UNF	-	16	34	1 11/32	660	0.88	364	14.3	3.7	8.16	1.20	42.4	12.7	1/2

TOOL SELECTION GUIDE

Standard models

Model	Trigger	
	Outside trigger	Inside trigger (C)
FRD-12Z-1 E	541 205 3255	
FRD-12Z-1C E		541 205 3257
FRD-16Z-1 E	541 205 3261	
FRD-16Z-1C E		541 205 3264

CE certified models

Model	Trigger	
	Outside trigger	Inside trigger (C)
FRD-12Z-1C EC	541 207 2133	
FRD-16Z-1C EC	541 207 2139	

For CE region availability of non CE models, please inquire to your Fuji representative.

NPT models

Model	Trigger	
	Outside trigger	Inside trigger (C)
FRD-12Z-1 N	541 205 3253	
FRD-16Z-1 N	541 205 3259	
FRD-16Z-1C N		541 205 3262

For possibility of NPT inlet for other models, please inquire to your Fuji representative.

HEAVY-DUTY DRILLS



FRD-40R~50R~65R



FRD-20R~32R



FRD-75R~100R

GLOBAL SPECIFICATIONS

Model	Drilling Capacity		Reaming Tapping		Stall Torque		Free Speed	Socket	Feed Length		Power		Overall Length		Weight		Max. Air Consumption		Air Hose Size	
	mm	in	mm	in	N.m	ft.lb	min ⁻¹	M.T.#	mm	in	W	hp	mm	in	kg	lb	m ³ /min	ft ³ /min	mm	in
FRD-20R-21	19	3/4	16	5/8	63.7	47	600	2	67	2.64	880	1.18	282	11.1	7	15.4	1.20	42.4	12.7	1/2
FRD-20R-22	19	3/4	16	5/8	63.7	47	600	3	67	2.64	880	1.18	307	12.1	7	15.4	1.20	42.4	12.7	1/2
FRD-23R-21	22	7/8	19	3/4	78.4	57.8	480	2	67	2.64	880	1.18	282	11.1	7.3	16.1	1.20	42.4	12.7	1/2
FRD-23R-22	22	7/8	19	3/4	78.4	57.8	480	3	67	2.64	880	1.18	307	12.1	7.4	16.3	1.20	42.4	12.7	1/2
FRD-25R-11	25	1	22	7/8	147	108	530	3	96	3.78	2100	2.81	353	13.9	14	30.8	3.20	113	19	3/4
FRD-28R-11	28	1 1/8	25	1	177	130	430	3	96	3.78	2100	2.81	353	13.9	14	30.8	3.20	113	19	3/4
FRD-32R-11	32	1 1/4	25	1	196	145	380	3	96	3.78	2100	2.81	353	13.9	14.5	31.9	3.20	113	19	3/4
FRD-32R-12	32	1 1/4	25	1	196	145	380	4	96	3.78	2100	2.81	353	13.9	14.5	31.9	3.20	113	19	3/4
FRD-40R-11	44	1 3/4	32	1 1/4	304	224	220	4	93	3.66	1800	2.41	446	17.6	18.7	41.1	3.20	113	19	3/4
FRD-50R-11	50	2	50	2	431	318	150	4	93	3.66	1800	2.41	446	17.6	18.7	41.1	3.20	113	19	3/4
FRD-65R-1	65	2 9/16	65	2 9/16	608	448	190	5	125	4.92	3300	4.42	487	19.2	32	70.4	5.50	194.2	25.4	1
FRD-75R-1	75	3	75	3	1156	1156	85	5	128	5.04	3100	4.15	600	23.6	43	94.6	5.50	194.2	25.4	1
FRD-100R-1	100	4	100	4	1823	1345	55	5	128	5.04	3100	4.15	600	23.6	43	94.6	5.50	194.2	25.4	1

TOOL SELECTION GUIDE

Standard models

Model	Handle	
	Normal roll handle	Self return type (S)
FRD-20R-21	541 205 3265	541 205 3267
FRD-20R-22	541 205 3269	541 205 3271
FRD-23R-21	541 205 3273	541 205 3275
FRD-23R-22	541 205 3277	541 205 3279
FRD-25R-11	541 205 3282	541 205 3284
FRD-28R-11		541 205 3288
FRD-32R-11	541 205 3290	541 205 3292
FRD-32R-12	541 205 3294	541 205 3296
FRD-40R-11	541 205 3298	541 205 3300
FRD-50R-11	541 205 3313	541 205 3315
FRD-65R-1	541 205 3353	541 205 3355
FRD-75R-1 E	541 205 3358	541 205 3359
FRD-100R-1 E	541 205 3250	

CE certified models

Model	Handle	
	Outside trigger	Self return type (S)
FRD-20R-21S EC	541 207 2141	
FRD-20R-22S EC	541 207 2143	
FRD-23R-21S EC	541 207 2148	
FRD-23R-22S EC	541 207 2150	
FRD-25R-11S EC	541 207 2154	
FRD-28R-11S EC	541 207 2157	
FRD-32R-11S EC	541 207 2161	
FRD-32R-12S EC	541 207 2165	
FRD-40R-11S EC	541 207 2168	
FRD-50R-11S EC	541 207 2172	
FRD-65R-1S EC	541 207 2182	
FRD-75R-1S EC	541 207 2234	

For CE region availability of non CE models, please inquire to your Fuji representative.

NPT models

Model	Handle	
	Outside trigger	Self return type (S)
FRD-20R-21 N	541 205 3268	
FRD-20R-22 N	541 205 3272	
FRD-23R-21 N	541 205 3276	
FRD-23R-22 N	541 205 3280	
FRD-50R-11 N	541 205 3314	
FRD-75R-1 N	541 205 3360	

For possibility of NPT inlet for other models, please inquire to your Fuji representative.

BABY ANGLE DRILLS

BABY ANGLE DRILLS

Fuji Baby Angle Drills are equipped with a compact head (low height and side-to-center head dimensions) to allow these tools to be used in confined areas. Ball and needle bearings used throughout angle heads provide long service life and less spindle run-out.



FCD-6A-1



FCD-6B-1



FCD-6EX-3



FCD-6EX-4

SNAKE DRILLS (SN-2~6)



Thread 1/4-28

DRILL CHUCKS (CN-1802-1808)



Thread 1/4-28

Snake Drill Bits 2mm to 6mm and Drill Chuck capacities 1/16" to 1/4" are available on request

GLOBAL SPECIFICATIONS

Model	Drilling Capacity		Stall Torque		Free Speed	Spindle Thread Size	Side to Center		Power		Overall Length		Weight		Max. Air Consumption		Air Hose Size	
	mm	in	N.m	ft.lb	min ⁻¹	in	mm	in	W	hp	mm	in	kg	lb	m ³ /min	ft ³ /min	mm	in
Front Exhaust Type																		
FCD-6A-1	6	1/4	2.5	1.8	2500	1/4-28UNF	9.5	3/8	160	0.21	223	8.76	0.6	1.32	0.56	19.8	6.3	1/4
FCD-6B-1	6	1/4	2.5	1.8	2500	1/4-28UNF	9.5	3/8	160	0.21	222	8.72	0.6	1.32	0.56	19.8	6.3	1/4
Rear Exhaust Type																		
FCD-6EX-3	6	1/4	2.9	2.1	3500	1/4-28UNF	8.5	11/32	270	0.36	246	9.66	0.69	1.52	0.76	26.9	6.3	1/4
FCD-6EX-4	6	1/4	2.9	2.1	3500	1/4-28UNF	8.5	11/32	270	0.36	246	9.66	0.69	1.52	0.76	26.9	6.3	1/4

Air Inlet Thread Size: PT 1/4"

TOOL SELECTION GUIDE

Standard models

Model	Throttle Type		
	Button	Lever	Locking Lever (F)
FCD-6A-1 E	541 205 2522		
FCD-6B-1 E		541 205 2523	541 205 2526
FCD-6EX-3	541 205 2527		
FCD-6EX-4		541 205 2529	541 205 2531

CE certified models

Model	Throttle Type	
	Locking Lever (F)	
FCD-6B-1F EC	541 207 1265	

For CE region availability of non CE models, please inquire to your Fuji representative.

NPT models

Model	Throttle Type	
	Lever (F)	
FCD-6EX-4 N	541 205 2530	

For possibility of NPT inlet for other models, please inquire to your Fuji representative.

CORNER DRILLS

Fuji utilizes their power transmission knowledge in their line of corner drills. In addition to their power, these drills are designed to work well in confined spaces.



FCD-6X-1, 2

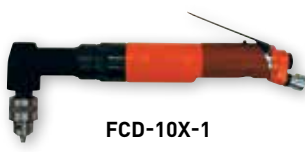

FCD-10X-1



FCD-6X-1F, 2F



FCD-10X-1F

GLOBAL SPECIFICATIONS

Model	Drilling Capacity		Stall Torque		Free Speed	Spindle Thread Size	Side to Center		Power		Overall Length		Weight		Max. Air Consumption		Air Hose Size	
	mm	in	N.m	ft.lb	min ⁻¹	in	mm	in	W	hp	mm	in	kg	lb	m ³ /min	ft ³ /min	mm	in
FCD-6X-1	6	1/4	4.9	3.6	2500	3/8-24UNF	21	17/20	290	0.39	267	10.5	1.7	3.75	0.68	24	9.5	3/8
FCD-6X-2	6	1/4	7.8	5.7	1500	3/8-24UNF	21	17/20	290	0.39	281	11.1	1.9	4.19	0.68	24	9.5	3/8
FCD-10X-1	10	7/16	11.8	8.6	1200	1/2-20UNF	21	17/20	420	0.56	377	14.8	2.2	4.85	0.50	17.6	9.5	3/8
FCD-10X-1 13 N	10	7/16	11.8	8.6	1200	1/2-20UNF	21	17/20	420	0.56	377	14.8	2.2	4.85	0.50	17.6	9.5	3/8

TOOL SELECTION GUIDE

Standard models

Model	Throttle Type	
	Lever	Locking Lever (F)
FCD-10X-1 E	541 205 2497	541 205 2500
FCD-6X-1 E	541 205 2534	541 205 2536
FCD-6X-2 E	541 205 2539	541 205 2541

CE certified models

Model	Throttle Type	
	Locking Lever (F)	
FCD-6B-1F EC	541 207 1265	
FCD-6X-1F EC	541 210 3012	
FCD-6X-2F EC	541 207 1273	
FCD-10X-1F EC	541 207 1242	

For CE region availability of non CE models, please inquire to your Fuji representative.

NPT models

Model	Throttle Type	
	Lever	Locking Lever (F)
FCD-6X-1F N	541 205 2535	
FCD-10X-1F N	541 205 2498	
FCD-10X-1 13 N	541 210 2620	

For possibility of NPT inlet for other models, please inquire to your Fuji representative.

HEAVY-DUTY CORNER DRILLS (NON-REVERSIBLE)



GLOBAL SPECIFICATIONS

Model	Drilling Capacity		Reaming Tapping		Stall Torque		Free Speed	Socket	Side to Center		Feed Length		Power		Overall Length		Weight		Max. Air Consumption		Air Hose Size	
	mm	in	mm	in	N.m	ft.lb	min ⁻¹	M.T.#	mm	in	mm	in	W	hp	mm	in	kg	lb	m ³ /min	ft ³ /min	mm	in
F-14CN	14	9/16	9.5	3/8	31.4	23.1	1000	1	24	15/16	38	1.5	740	0.73	410	16.1	4.6	10.1	1.25	44.1	12.7	1/2
F-14CN-2	14	9/16	9.5	3/8	31.4	23.1	1000	2	24	15/16	38	1.5	740	0.73	410	16.1	4.6	10.1	1.25	44.1	12.7	1/2
F-22RCN	22	7/8	19	3/4	108	79.5	450	3	35	1 3/8	60	2.36	1100	1.48	493	19.4	8.5	18.7	1.50	53	12.7	1/2
F-32RCNS	32	1 1/4	25	1	127	94	400	3	40	1 3/5	25	0.98	1100	1.48	529	20.8	8.8	19.3	1.50	53	12.7	1/2

TOOL SELECTION GUIDE

Standard models

Model	Handle	
	Normal roll handle	Self return type (S)
F-14CN E	541 205 2073	
F-14CN-1S		541 205 2074
F-14CN-2 E	541 205 2077	
F-14CN-2S		541 205 2078
F-22RCN E	541 205 2089	
F-22RCN-1S		541 205 2090
F-32RCN E	541 205 2106	
F-32RCN-1S		541 205 2107
F-32RCNS E		541 205 2110

CE certified models

Model	Handle
	Self return type (S)
F-14CN-1S EC	541 207 1001
F-14CN-2S EC	541 207 1003
F-22RCN-1S EC	541 207 1013
F-32RCN-1S EC	541 207 1020
F-32RCNS-1S EC	541 207 1022

For CE region availability of non CE models, please inquire to your Fuji representative.

NPT models

Model	Handle
	Self return type (S)
F-14CN-1S N	541 205 2075

For possibility of NPT inlet for other models, please inquire to your Fuji representative.

HEAVY-DUTY CORNER DRILLS (REVERSIBLE)

Model	Drilling Capacity		Reaming Tapping		Stall Torque		Free Speed	Socket	Side to Center		Feed Length		Power		Overall Length		Weight		Max. Air Consumption		Air Hose Size	
	mm	in	mm	in	N.m	ft.lb	min ⁻¹	M.T.#	mm	in	mm	in	W	hp	mm	in	kg	lb	m ³ /min	ft ³ /min	mm	in
F-22RCR	22	7/8	19	3/4	93.2	68.7	400	2	35	1 3/8	60	2.36	900	1.2	505	19.9	8.5	18.7	1.50	53	12.7	1/2
F-32RCR	32	1 1/4	25	1	113	83.1	315	3	40	1 3/5	60	2.36	960	1.28	538	21.2	10	22	1.50	53	12.7	1/2
FCD-23R-12	22	7/8	19	3/4	80.4	59.3	430	2	27	1 1/16	35	1.38	900	1.2	472	18.6	7.1	15.6	1.50	53	12.7	1/2
FCD-23R-11	22	7/8	19	3/4	80.4	59.3	430	3	27	1 1/16	35	1.38	900	1.2	472	18.6	7	15.4	1.50	53	12.7	1/2
FCD-32R-11	32	1 1/4	32	1 1/4	177	130	350	3	35	1 3/8	53	1.38	1600	2.14	578	22.8	13.5	29.7	1.80	63.5	12.7	1/2
FCD-50R-11	50	2	50	2	392	289	140	4	41	1 5/8	58	1.38	1600	2.14	595	23.4	16	35.3	2.25	79.4	19	3/4
FCD-75R-11	75	3	75	3	834	615	85	5	49	1 15/16	57	2.24	1900	2.56	651	25.6	20.5	45.1	2.50	88.3	19	3/4
FCD-100R-11	100	4	100	4	1370	1013	40	5	62	2 7/16	105	4.13	1600	2.17	730	28.7	29.3	64.4	2.25	79.4	19	3/4

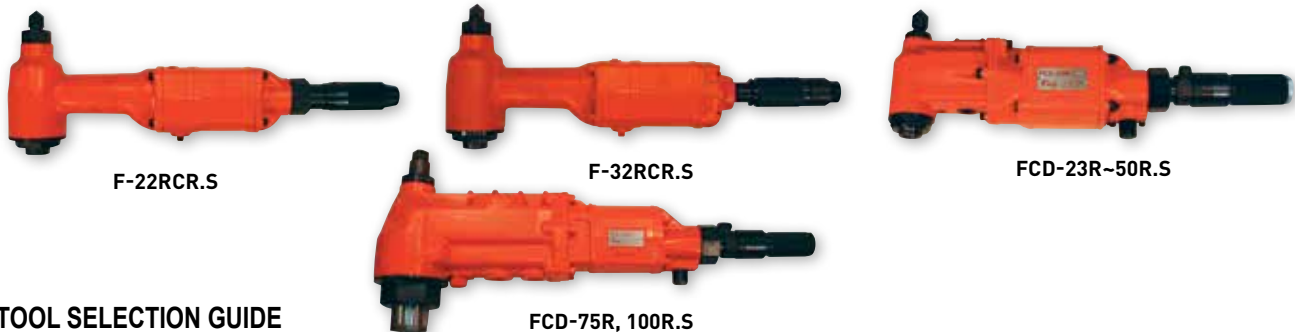

TOOL SELECTION GUIDE

Standard models

Model	Handle	
	Normal roll handle	Self return type (S)
F-22RCR-1S		541 205 2094
F-22RCR E	541 205 2093	
F-32RCR-1S		541 205 2115
F-32RCR E	541 205 2114	
FCD-75R-11 E	541 205 2544	541 205 2546
FCD-50R-11 E	541 205 2518	541 205 2520
FCD-32R-11 E	541 205 2514	541 205 2516
FCD-23R-12 E	541 205 2510	541 205 2512
FCD-23R-11 E	541 205 2506	541 205 2508
FCD-100R-11 E	541 205 2502	541 205 2504

CE certified models

Model	Handle
	Self return type (S)
F-22RCR-1S EC	541 207 1016
F-32RCR-1S EC	541 207 1024
FCD-75R-11S EC	541 207 1278
FCD-50R-11S EC	541 207 1260
FCD-32R-11S EC	541 207 1256
FCD-23R-12S EC	541 207 1252
FCD-23R-11S EC	541 207 1247
FCD-100R-11S EC	541 207 1238

For CE region availability of non CE models, please inquire to your Fuji representative.

NPT models

Model	Handle
	Self return type (S)
FCD-23R-11S N	541 205 2507
FCD-23R-12S N	541 205 2511
FCD-32R-11S N	541 205 2515
FCD-50R-11S N	541 205 2519
FCD-75R-11S N	541 205 2545
FCD-100R-11S N	541 205 2503

For possibility of NPT inlet for other models, please inquire to your Fuji representative.

DRILLS

ACCESSORIES

COLLET CHUCKS, SNAKE DRILLS, ATTACHMENT AND PADS FOR FCD-6A, 6B AND 6EX

COLLET CHUCKS

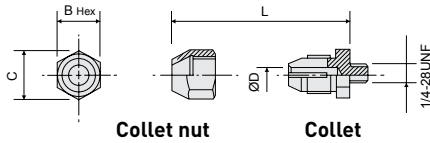

SNAKE DRILLS

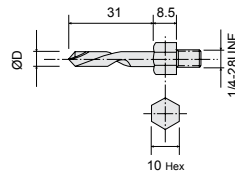

VELCRO RUBBER PAD

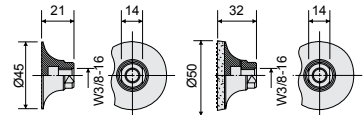

Item N°/ PN
MP-2-1
541 205 4843

Item N°/ PN
MP-2-1S
541 205 4844

Kit	Collet nut		Collet		Size					
	Kit N°	Part Number	Item N°	Part Number	D	B(Hex)	C	L		
CN-1802	541 205 1123	D-021343-00	541 207 0527	D-021342-00	541 207 0526	3	-	12	13.8	15
CN-1804	541 205 1125	D-023343-01	541 207 0537	D-023342-01	541 207 0532	4	-	14	16.2	21
CN-1806	541 205 1127	D-023343-01	541 207 0537	D-023342-02	541 207 0533	5	-	14	16.2	21
CN-1807	541 205 1128	D-023343-00	541 207 0536	D-023342-04	541 207 0535	6	-	17	19.6	23
CN-1808	541 205 1129	D-023343-00	541 207 0536	D-023342-00	541 207 0531	-	1/4	17	19.6	23

AC Number	Part Number	Size
		D
SN-2	541 205 8954	2
SN-3	541 205 8955	3
SN-4	541 205 8956	4
SN-5	541 205 8957	5
SN-6	541 205 8958	6

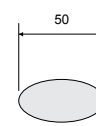

AC Number	Part Number	Grit #
MP-2-10	541 207 4556	40
MP-2-2	541 205 4845	60
MP-2-3	541 207 4557	80
MP-2-4	541 205 4846	100
MP-2-5	541 207 4558	120
MP-2-6	541 205 4847	150
MP-2-7	541 207 4559	240
MP-2-8	541 205 4848	320

*Minimum order required : 100pcs. per item.

VELCRO SANDING PAPERS

STIRRING PROPELLERS

AC No. : AT-P01

For use with 10mm Drill Chuck

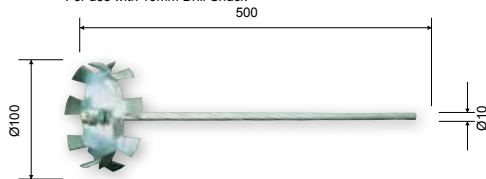

AC No. : AT-P02

For use with 13mm Drill Chuck

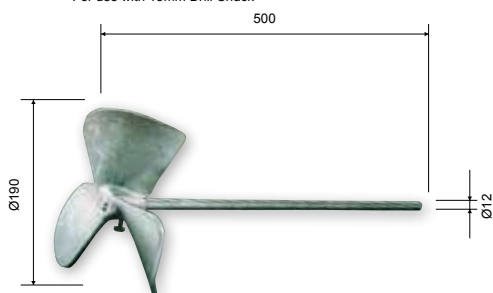

ADAPTERS TO CONNECT PROPELLERS TO DRILLS

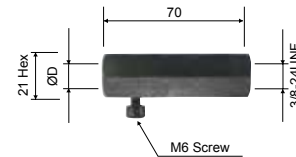

Item N°	Part Number	Size	stirring propellers Item	Part Number	Models
		D			
M-002693-01	541 205 4644	10	AT-P01	541 205 0902	FRD-5S, 6S-2-5
M-002693-00	541 205 4643	12	AT-P02	541 205 0903	5P, 8PX-1, 2

*These adapters are designed to connect propellers directly to drills.

DEAD HANDLE FOR FRD-12Z, 16Z

Item No. : A-192014-00 / PN : 541 205 0777

This dead handle softens vibration and eases operator's fatigue much more than the ordinary dead handle.



Item N°	Part Number
A-192014-00	541 205 0777

STIRRING PROPELLERS

Stirring propellers attached to FRD series drills



SOFT JACKETS

- Soften vibration and Chill-touch
- Protect work piece and tool
- Improve comfort



Item N°	Part Number	Applicable Dia.	Thickness x Length
		mm	mm
SO-30	541 205 6241	26 - 33	2 x 120
SO-35	541 205 6242	34 - 42	
SO-55	541 205 6243	56 - 70	

TAPPERS FEATURES

REVERSING

- A.** Twin lever type-one lever for forward rotation (with throttle actuation) and one lever for reverse rotation (with throttle actuation).
- B.** See-saw type lever for throttle actuation and reversing.
- C.** Push/Pull type-forward rotation when the tool is pushed into the work-piece, reverse rotation when the tool is pulled away from the work-piece.

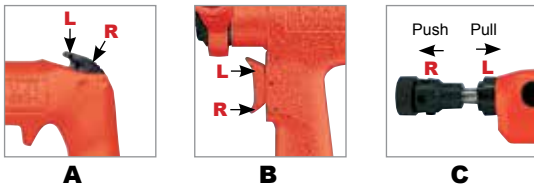
**TWO-STAGE THROTTLING**

This mechanism allows a "slow start" to ensure tap is correctly aligned prior to actuating "full speed".

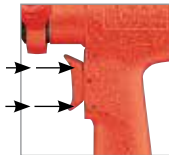
**AIR REGULATOR**

A 4 click stop regulator is built in and the operator can regulate air supply for torque adjustment.

**DEAD HANDLE**

The dead handle is used to reduce the effect of "snatching" when tapping a through hole. It is also used when tapping "high torque" threads.

**REAR EXHAUST WITH AIR EXHAUST HOSE**

Connecting an air exhaust hose, provides improved operator comfort by directing the exhaust air away and reducing the noise level.

**REAR EXHAUST WITH BUILT-IN MUFFLER**

The noise level is minimised via the muffler built into the exhaust cover.

**UNIVERSAL TAPPING CHUCK**

The universal tapping chuck provides optimal grip of the tap during the tapping operation.

**DRILL CHUCKS**

A drill chuck can also be used for tapping where appropriate.



TAPPERS

Easy to use throttle and reversing trigger combined with a universal tapping chuck provide a smooth tapping operation. Fuji Tappers are available in tapping capacities from 6mm to 13mm.



FT-6P-1



FT-6BX-1
(DRILL CHUCK TYPE)



FT-6BX-1
(UNIVERSAL TAPPING
CHUCK TYPE)



FT-8PX-1



FT-13Z-1

GLOBAL SPECIFICATIONS

Model	Tapping Capacity (Guidance)				Free Speed (min ⁻¹)		Type and Size of Spindle	Chuck Capacity	Overall Length		Weight		Max. Air Consumption		Air Hose Size	
	Steel		Aluminum		R	L			mm	in	kg	lb	m ³ /min	ft ³ /min	mm	in
	mm	in	mm	in			Tapper #	M.T.#								
FT-6P-1	6	1/4	8	5/16	1000	1000	Jacobs Taper 1	8	236	9.29	1.8	3.97	0.50	17.7	9.5	3/8
FT-6BX-1	6	1/4	8	5/16	2000	2000	Jacobs Taper 1	8	240	9.45	1.3	2.87	0.56	19.8	8	5/16
FT-8PX-1	8	5/16	10	3/8	450	450	MT1	9	232	9.13	2	4.41	0.50	17.7	9.5	3/8
FT-13Z-1	13	1/2	8	5/16	400	400	Jacobs Taper 6	13	384	15.1	4	8.8	1.25	44.1	12.7	1/2

*FT-6P-1, 6BX-1, 8PX-1: Air Inlet Thread Size: PT 1/4"

*FT-13Z-1: Air Inlet Thread Size: PT 3/8"

TOOL SELECTION GUIDE

Standard models

Model	Chuck	
	Drill Chucks (D)	Tapping Chucks (T)
FT-6P-1	541 205 3490	541 210 2735
FT-6BX-1	541 205 3486	541 205 3487
FT-8PX-1	541 207 2340	
FT-13Z-1	541 205 3485	

CE certified models

Model	Chuck	
	Drill Chucks (D)	Tapping Chucks (T)
FT-6BX-1 D EC	541 207 2337	541 207 2338
FT-8PX-1 EC	541 207 2341	
FT-8PX-1 WO C EC	541 207 2343	
FT-13Z-1 EC	541 207 2333	
FT-13Z-1C EC	541 207 2334	

For CE region availability of non CE models, please inquire to your Fuji representative.

NPT models

Model	Chuck	
	Drill Chucks (D)	Tapping Chucks (T)
FT-6P-1 N	541 205 3491	
FT-6BX-1 D N	541 207 2336	
FT-6BX-1 T N		541 205 3488
FT-8PX-1 N	541 205 3492	
FT-13Z-1 N	541 210 2787	

For possibility of NPT inlet for other models, please inquire to your Fuji representative.

ACCESSORIES

TAPPING CHUCKS



N°	Part Number	Models	Type and Size of Spindle Taper #	Chuck Capacity
TCK-6	541 205 6510	FT-6BX-1T	J.T.#1	8mm
TCK-8F	541 205 6511	FT-8PX-1	M.T.#1	9mm
TCK-13-1	541 205 6507	FT-13Z-1	J.T.#6	13mm

DRILL CHUCKS



N°	Part Number	Models	Type and Size of Spindle Taper #	Chuck Capacity
DCK-6.5J	541 205 2009	FT-6BX-1(D Type)	J.T.#1	6.5mm
DCK-8J	541 205 2011	FT-6P-1	J.T.#1	8mm



PERCUSSIVE TOOLS

PERCUSSIVE TOOLS FEATURES _____	82
FLUX CHIPPERS / LIGHT HAMMERS _____	83
CHIPPING & CALKING HAMMERS / NEEDLE SCALERS_	85
SCALING HAMMERS / SAND RAMMERS _____	87
ACCESSORIES _____	88

PERCUSSIVE TOOLS FEATURES

VALVE MECHANISM

Equipped with following valve mechanism, Fuji Percussion Tools have trouble-free long life.

A. PLATE VALVE

Plate valve consists of four parts of valve sheet, valve cover, valve case and valve. This simple mechanism and plate valve surface provide longer durability.

FR Series

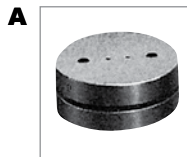

B. SLEEVE VALVE

Hollow valve enables a light and compact body and longer stroke for its size.



C. PISTON VALVE

High blow frequency (60Hz to 90Hz) can be maintained as this piston functions as a valve providing high working efficiency.



LOW AIR CONSUMPTION

Low air consumption 0.14-0.18 m³/min (due to the valve mechanism) enables Fuji Percussion Tools to be used with a smaller compressor.



QUICK CHANGE ATTACHMENTS FOR PERCUSSIVE TOOLS

Attachment, such as chisels and needles, can be quickly and easily changed.



MULTI-NEEDLES

Fuji Needle Scalers utilise multiple needles that do not contaminate the workpiece.



PLASTIC HANDLE COVER

The plastic handle cover reduces the effect of vibration and provides an insulated grip for the operator.



LOCKING HANDLE

The locking handle are designed to reduce the risk of accidental starting of the tools. The handle is automatically locked when the operator releases the handle.

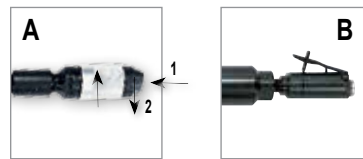

A. Locking Roll Handle : FS-2A

B. Locking Locking Lever Handle : FS, FR, FCH, FNS Series

LOW BLOW FREQUENCY

The built-in Sleeve Valve allows the operator to adjust the blow frequency by adjusting the throttle valve.



CHISEL RETAINER

A. Holder Spring (Bee-Hive Retainer)

B. Holder Spring (B) (Quick Change Retainer)

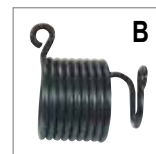
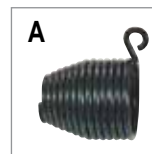

CHISEL HOLDER

Fuji Chipping and Calking Hammers are supplied with a chisel holder as standard. This reduces the risk of the chisel releasing during operation.

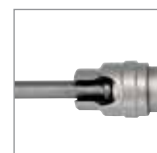

PERCUSSIVE TOOLS

Fuji offers 3 variants of flux chippers with different removal rates.

They are ideal for various removal operations; light chipping, carving stone, scaling, removing paint, rust, weld flux and light fins from castings. FCH-25B offers a "blow" function which is ideal for blowing particles away from the work piece.

FLUX CHIPPERS



FCH-20



FCH-20F



FCH-25



FCH-25B
(SEPARATE BLOW TYPE)



FCH-25-1F



FCH-25B-1F
(SEPARATE BLOW TYPE)

GLOBAL SPECIFICATIONS

Model	Blows	Piston Diameter		Stroke		Overall Length		Weight		Air Consumption (at Load)		Air Hose Size	
	Hz	mm	in	mm	in	mm	in	kg	lb	m ³ /min	ft ³ /min	mm	in
FCH-20	90	20	0.787	16	0.63	176	6.93	0.8	1.8	0.14	4.9	6.3	1/4
FCH-20F	90	20	0.787	16	0.63	182	7.17	1	2.2	0.14	4.9	9.5	3/8
FCH-25	60	25	0.984	20	0.79	204	8.03	1.5	3.3	0.18	6.4	9.5	3/8
FCH-25B	60	25	0.984	20	0.79	204	8.03	1.5	3.3	0.18	6.4	9.5	3/8

TOOL SELECTION GUIDE

Standard models

Model	Throttle Type	
	Lever	Locking Lever (1F)
FCH-20 E	541 205 2552	
FCH-20-1F		541 205 2553
FCH-20F-1F		541 205 2559
FCH-20F E	541 205 2557	
FCH-25 E	541 205 2562	
FCH-25-1F		541 205 2563
FCH-25B-1F		541 205 2567

CE certified models

Model	Throttle Type
	Locking Lever (1F)
FCH-20-1F EC	541 207 1281
FCH-20F-1F EC	541 207 1287
FCH-25-1F EC	541 207 1293
FCH-25B-1F EC	541 207 1300

For CE region availability of non CE models, please inquire to your Fuji representative.

NPT models

Model	Throttle Type	
	Lever	Locking Lever (1F)
FCH-20F N	541 205 2558	
FCH-20F-1F N		541 205 2560
FCH-25 N	541 205 2561	
FCH-25-1F N		541 205 2564
FCH-25B N	541 205 2565	

For possibility of NPT inlet for other models, please inquire to your Fuji representative.

PERCUSSIVE TOOLS

LIGHT HAMMERS

Fuji light hammers provide a controllable impact for rivetting to reduce the effect of work hardening of the rivet or damage to the surrounding metal. These tools are easily adapted to perform other operations, such as cutting, ripping, shearing, punching and gouging with suitable chisels fitted.



FRH-3



FRH-6



FRH-6A

GLOBAL SPECIFICATIONS

Model	Chisel Shank	Riveting Capacity (mm)		Blows Hz	Piston Diameter		Stroke		Overall Length		Weight		Air Consumption (at Load)		Air Hose Size	
		Duralmin	Steel		mm	in	mm	in	mm	in	kg	lb	m ³ /min	ft ³ /min	mm	in
FRH-3-1	Chisels (Hex. Shank)	0.125	0.09	60	14.3	0.563	38	1.5	140	5.51	1.1	2.4	0.35	12.4	9.5	3/8
FRH-3-2	Chisels (round shank)	0.125	0.09	60	14.3	0.563	38	1.5	140	5.51	1.1	2.4	0.35	12.4	9.5	3/8
FRH-6-1	Chisels (Hex. Shank)	0.25	0.19	30	12.7	0.5	100	3.94	206	8.11	1.4	3.1	0.35	12.4	9.5	3/8
FRH-6-2	Chisels (round shank)	0.25	0.19	30	12.7	0.5	100	3.94	206	8.11	1.4	3.1	0.35	12.4	9.5	3/8
FRH-6A-1	Chisels (Hex. Shank)	0.25	0.19	50	20	0.787	44.5	1.75	193	7.6	1.5	3.3	0.40	14.1	9.5	3/8
FRH-6A-2	Chisels (round shank)	0.25	0.19	50	20	0.787	44.5	1.75	193	7.6	1.5	3.3	0.40	14.1	9.5	3/8

TOOL SELECTION GUIDE

Standard models

Model	Part Number
FRH-3-1 E	541 205 3381
FRH-3-2 E	541 205 3384
FRH-6-1 E	541 205 3389
FRH-6-2 E	541 205 3393
FRH-6A-1 E	541 210 3186
FRH-6A-2 E	541 205 3401

CE certified models

Model	Part Number
FRH-3-1 EC	541 207 2249
FRH-3-2 EC	541 207 2253
FRH-6-1 EC	541 207 2260
FRH-6-2 EC	541 207 2264
FRH-6A-1 EC	541 207 2266
FRH-6A-2 EC	541 207 2271

For CE region availability of non CE models, please inquire to your Fuji representative.

NPT models

Model	Part Number
FRH-3-1 N	541 205 3378
FRH-6-2 N	541 205 3390
FRH-6A-2 N	541 205 3398

For possibility of NPT inlet for other models, please inquire to your Fuji representative.

FRH-SERIES KIT

- FRH-Model
- Air Regulator
- Hose Nipple
- Holder Spring
- Holder Spring (B)
- 7 kinds of Chisel
- Metal Carrying Case



CHIPPING & CALKING HAMMERS

Fuji chipping and calking hammers are durable. They are excellent for concrete, stone, weld flux removal.



FC-01SA



FC-01



FC-1Z-4Z

GLOBAL SPECIFICATIONS

Model	Blows	Piston Diameter		Stroke		Chisel Insert		Overall Length		Weight		Air Consumption (at Load)		Air Hose Size	
	Hz	mm	in	mm	in	mm	in	mm	in	kg	lb	m ³ /min	ft ³ /min	mm	in
FC-01SA-H	50	20	0.787	44.5	1.75	12 x 45	0.472 x 1.772	273	10.7	2.5	5.5	0.42	14.8	9.5	3/8
FC-01SA-R	50	20	0.787	44.5	1.75	14 x 45	0.551 x 1.772	273	10.7	2.5	5.5	0.42	14.8	9.5	3/8
FC-01-3	50	20	0.787	44.5	1.75	12 x 45	0.472 x 1.772	273	10.7	2.6	5.7	0.42	14.8	9.5	3/8
FC-01-4	50	20	0.787	44.5	1.75	14 x 45	0.551 x 1.772	273	10.7	2.6	5.7	0.42	14.8	9.5	3/8
FC-1Z-1	50	28.5	1.12	25	0.984	14.8 x 60	0.583 x 2.362	301	13.5	5	11	0.60	21.2	12.7	1/2
FC-1Z-2	50	28.5	1.12	25	0.984	17.5 x 60	0.689 x 2.362	301	13.5	5	11	0.60	21.2	12.7	1/2
FC-2Z-1	50	28.5	1.12	51	2.01	14.8 x 60	0.583 x 2.362	342	13.5	5.7	12.5	0.60	21.2	12.7	1/2
FC-2Z-2	42	28.5	1.12	51	2.01	17.5 x 60	0.689 x 2.362	342	13.5	5.7	12.5	0.60	21.2	12.7	1/2
FC-3Z-1	33	28.5	1.12	76	2.99	14.8 x 60	0.583 x 2.362	386	13.5	6.3	13.9	0.65	23	12.7	1/2
FC-3Z-2	33	28.5	1.12	76	2.99	17.5 x 60	0.689 x 2.362	386	13.5	6.3	13.9	0.65	23	12.7	1/2
FC-4Z-1	28	28.5	1.12	102	4.02	14.8 x 60	0.583 x 2.362	425	16.7	6.8	15	0.65	23	12.7	1/2
FC-4Z-2	28	28.5	1.12	102	4.02	17.5 x 60	0.689 x 2.362	425	16.7	6.8	15	0.65	23	12.7	1/2

TOOL SELECTION GUIDE

Standard models

Model	Shank shape	
	Hex. Shank	Round Shank
FC-01SA-H	541 205 2476	
FC-01SA-R		541 205 2478
FC-01-3	541 205 2471	
FC-01-4		541 205 2474
FC-1Z-1	541 205 2480	
FC-1Z-2		541 205 2482
FC-2Z-1	541 205 2484	
FC-2Z-2		541 205 2486
FC-3Z-1	541 205 2488	
FC-3Z-2		541 205 2490
FC-4Z-1	541 205 2492	
FC-4Z-2		541 205 2494

CE certified models

Model	Shank shape	
	Hex. Shank	Round Shank
FC-01SA-H	541 207 1216	
FC-01SA-R		541 207 1217
FC-01-3	541 207 1209	
FC-01-4		541 207 1211
FC-1Z-1	541 207 1220	
FC-1Z-2	541 207 1226	
FC-2Z-2		541 207 1228
FC-3Z-1	541 207 1230	
FC-3Z-2		541 207 1231
FC-4Z-1	541 207 1232	

For CE region availability of non CE models, please inquire to your Fuji representative.

NPT models

Model	Shank shape	
	Hex. Shank	Round Shank
FC-01SA-H	541 205 2477	
FC-01-3	541 205 2472	
FC-01-4		541 205 2475
FC-1Z-1	541 205 2481	
FC-2Z-1	541 205 2485	
FC-3Z-1	541 210 2799	
FC-4Z-1	541 205 2493	
FC-4Z-2		541 205 2495

For possibility of NPT inlet for other models, please inquire to your Fuji representative.

PERCUSSIVE TOOLS

NEEDLE SCALERS

Fuji needle scalers are useful for removing weld flux, sand from castings, scales from forgings, rust, paint, scales from ship hulls and finishing rough surfaces of rock or concrete. Fuji needle scalers feature a unique valve less design and work well on uneven or irregular surfaces.



FNS-2



FNS-2P

MOVEMENT OF NEEDLES

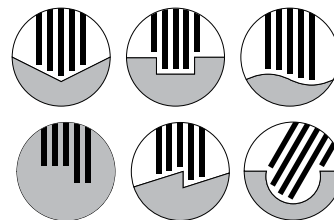

GLOBAL SPECIFICATIONS

Model	Throttle Type	Blows Hz	Piston Diameter		Needle Roller		N° and Dia. of Needle		Needle Stroke		Overall Length		Weight		Air Consumption (at Load)		Air Hose Size	
			mm	in	mm	in	3 mm	2 mm	mm	in	mm	in	kg	lb	m ³ /min	ft ³ /min	mm	in
FNS-2	Straight	133	25	0.984	180	7 3/32	19	37	7	9/32	325	12.8	1.9	4.2	0.18	6.4	9.5	3/8
FNS-2-1F	Straight	133	25	0.984	180	7 3/32	19	37	7	9/32	325	12.8	1.9	4.2	0.18	6.4	9.5	3/8
FNS-2P	Pistol	133	25	0.984	180	7 3/32	19	37	7	9/32	371	14.6	2.5	5.5	0.18	6.4	9.5	3/8
FNS-2P-1F	Pistol	133	25	0.984	180	7 3/32	19	37	7	9/32	371	14.6	2.5	5.5	0.18	6.4	9.5	3/8

Air Inlet Thread Size: PT 1/4"

*Specify needle diameter (3mm or 2mm) when ordering.

TOOL SELECTION GUIDE

Standard models

Model	Needle Diameter	
	2 mm	3 mm
FNS-2	541 207 1942	541 205 3047
FNS-2-1F	541 205 3052	541 205 3051
FNS-2P	541 207 1949	541 205 3055
FNS-2P-1F	541 205 3060	541 205 3059

CE certified models

Model	Needle Diameter
	3 mm
FNS-2-1F	541 207 1947
FNS-2P-1F	541 207 1953

For CE region availability of non CE models, please inquire to your Fuji representative.

NPT models

Model	Needle Diameter
	3 mm
FNS-2	541 205 3045
FNS-2-1F	541 205 3049
FNS-2P	541 205 3053

For possibility of NPT inlet for other models, please inquire to your Fuji representative.

SCALING HAMMERS

These tools have proven to be very efficient in cleaning heavily oxidized surfaces which occur on ships' hulls, bridges and storage tanks.



FS-2A



FS-2A-1F

GLOBAL SPECIFICATIONS

Model	Blows	Piston Diameter		Stroke		Angle Height		Overall Length		Weight		Air Consumption (at Load)		Air Hose Size	
	Hz	mm	in	mm	in	mm	in	mm	in	kg	lb	m ³ /min	ft ³ /min	mm	in
FS-2A	133	30	1.18	16	0.63	94	3 11/16	510	20.1	2.5	5.5	0.25	8.8	9.5	3/8
FS-2A-1F	133	30	1.18	16	0.63	94	3 11/16	537	21.1	2.5	5.5	0.25	8.8	9.5	3/8

Air Inlet Thread Size: PT 3/8"

TOOL SELECTION GUIDE

Standard models

Model	Throttle	
	Lever	Locking Lever (F)
FS-2A	541 205 3480	
FS-2A-1F		541 205 3482

CE certified models

Model	Throttle	
	Lever	Locking Lever (F)
FS-2A-1F EC	541 207 2318	

For CE region availability of non CE models, please inquire to your Fuji representative.

SAND RAMMERS

Fuji sand rammers are powerful but light with a stroke range from 50mm to 127mm. Fuji sand rammers are excellent for ramming sand for casting in any ferrous or non-ferrous foundry. Non-rotary type rammers are available for use with irregular shaped butts.



FR-18B~25B



FR-18L~32



FR-18B-2F~25B-2F



FR-18L-2F~32-2F

GLOBAL SPECIFICATIONS

Model	Blows	Piston Diameter		Stroke		Angle Height		Overall Length		Weight		Air Consumption (at Load)		Air Hose Size	
	Hz	mm	in	mm	in	mm	in	mm	in	kg	lb	m ³ /min	ft ³ /min	mm	in
FR-18B	30	18	0.709	50	1.97	41	1 5/8	280	11	1.5	3.3	0.40	14.1	9.5	3/8
FR-18L	30	18	0.709	50	1.97	41	1 5/8	558	22	2	4.4	0.40	14.1	9.5	3/8
FR-22B	17	22	0.866	64	2.52	51	2 1/32	350	13.8	3	6.6	0.50	17.7	9.5	3/8
FR-22L	17	22	0.866	64	2.52	51	2 1/32	633	24.9	3.3	7.2	0.50	17.7	9.5	3/8
FR-25B	13	25.4	1	83	3.27	67	2 3/5	506	19.21	5.5	12.1	0.70	24.7	12.7	1/2
FR-25L	13	25.4	1	83	3.27	67	2 3/5	597	22.3	5.5	12.1	0.70	24.7	12.7	1/2
FR-32	12	32	1.26	127	5	75	3	1086	42.8	10	22.1	0.80	28.2	12.7	1/2

TOOL SELECTION GUIDE

Standard models

Model	Throttle	
	Lever	Locking Lever (2F)
FR-18B E	541 205 3216	541 205 3218
FR-18L E	541 205 3221	541 205 3223
FR-22B	541 205 3225	541 205 3227
FR-22L	541 205 3229	541 205 3231
FR-25B	541 205 3233	541 205 3235
FR-32	541 205 3241	541 205 3243

CE certified models

Model	Throttle
	Locking Lever (2F)
FR-18B-2F	541 207 2109
FR-18L-2F	541 207 2112
FR-22B-2F	541 207 2115
FR-22L-2F	541 207 2116
FR-25B-2F	541 207 2118
FR-25L-2F	541 207 2119
FR-32-2F	541 207 2121

For CE region availability of non CE models, please inquire to your Fuji representative.

NPT models

Model	Throttle	
	Lever	Locking Lever (2F)
FR-18B	541 205 3215	541 205 3217
FR-18B-2F		
FR-18L-2F		541 205 3224
FR-22B	541 205 3226	
FR-25B	541 205 3234	
FR-25L	541 205 3238	
FR-32	541 205 3242	

For possibility of NPT inlet for other models, please inquire to your Fuji representative.

PERCUSSIVE TOOLS

ACCESSORIES

CHISELS FOR FCH-20

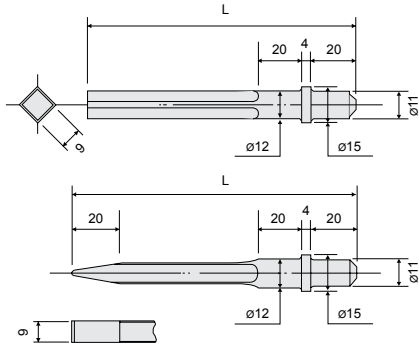

Type	Item N°	Part Number	Size
			L mm
Blank	G-1-1	541 205 3807	125
	G-1-2	541 205 3808	155
	G-1-3	541 205 3809	200
	G-1-4	541 205 3810	250
	G-1-5	541 207 2605	300
Flat	G-2-1	541 205 4197	130
	G-2-2	541 205 4198	155
	G-2-3	541 205 4199	200
	G-2-4	541 205 4200	250
	G-2-5	541 207 2795	300

TIPPED CHISELS FOR FCH-20

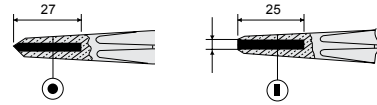

Type	Item N°	Part Number	Overall Length	Remark
			mm	
Point	S-1	541 205 5794	120	Standard
	S-3	541 205 6189	160	Small Point
	S-2	541 205 6188	120	Standard
Flat	S-4-1	541 205 6194	160	Small Flat

BUSHING CHISELS FOR FCH-20



Item n°	Part Number	Tip Size		
		Point	I x w x L	
TWH-0006	541 207 5674	4	2.5 x 2.5 x 5	

CHISELS FOR FCH-20F, 25 AND 25B

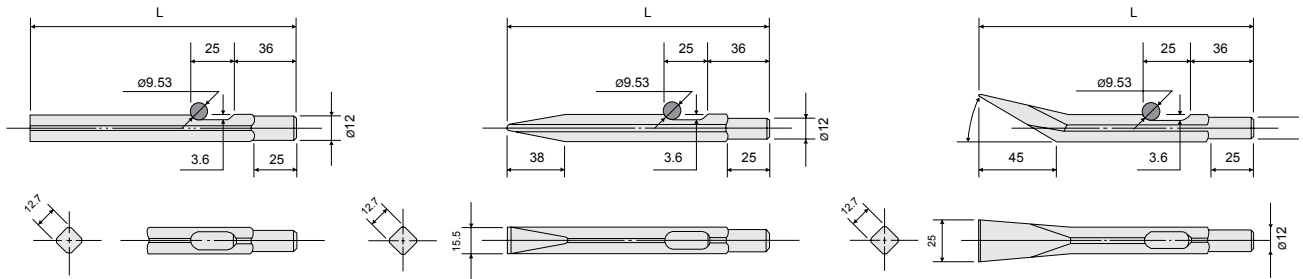

Type	Item N°	Part Number	Size
			L mm
Blank	F-1-1	541 205 2046	140
	F-1-2	541 205 2047	155
	F-1-3	541 205 2048	200
	F-1-4	541 205 2049	250
	F-1-5	541 205 2050	300

Type	Item N°	Part Number	Size
			L mm
Flat	F-2-2	541 205 2080	155
	F-2-3	541 205 2081	200
	F-2-4	541 205 2082	250
	F-2-5	541 205 2083	300
	F-2-7*	541 207 1017	400

Type	Item N°	Part Number	Size
			L mm
Flux	F-3-2	541 205 2096	155
	F-3-3	541 205 2097	200
	F-3-4	541 205 2098	250
	F-3-5	541 205 2099	300
	F-3-7	541 207 1026	400

*Minimum order required :10pcs. / item.

BUSHING CHISELS FOR FCH-20F, 25 AND 25B



Item N°	Part Number	Tip Size		
		Point	I x w x L	
TWH-0007	541 207 5675	4	6 x 6 x 12	
TWH-0003	541 207 5672	9	5 x 5 x 15	
TWH-0002	541 207 5671	16	4 x 4 x 16	
TWH-0004	541 207 5673	25	4.5 x 4.5 x 22.5	

ACCESSORIES

CHISELS FOR FRH SERIES

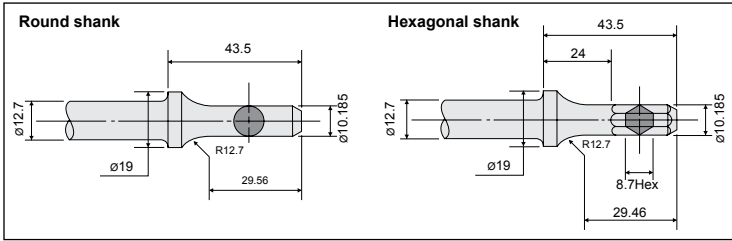

Type	AC Number				Part Name
	Round	Part Number	Hexagonal	Part Number	
808	WA-808	541 205 8692	WA-808H	541 205 8693	Muffler Cutter
809	WA-809	541 205 8694	WA-809H	541 205 8695	Double Edge Panel Cutter
810	WA-810	541 205 8696	WA-810H	541 205 8697	Flat Chisel
812	WA-812	541 205 8698	WA-812H	541 205 8699	Taper Punch
813	WA-813	541 205 8700	WA-813H	541 205 8701	Rivet Cutter
814	WA-814	541 205 8702	WA-814H	541 205 8703	Blank Chisel
815	WA-815	541 205 8704	WA-815H	541 205 8705	Spot Weld Breaker

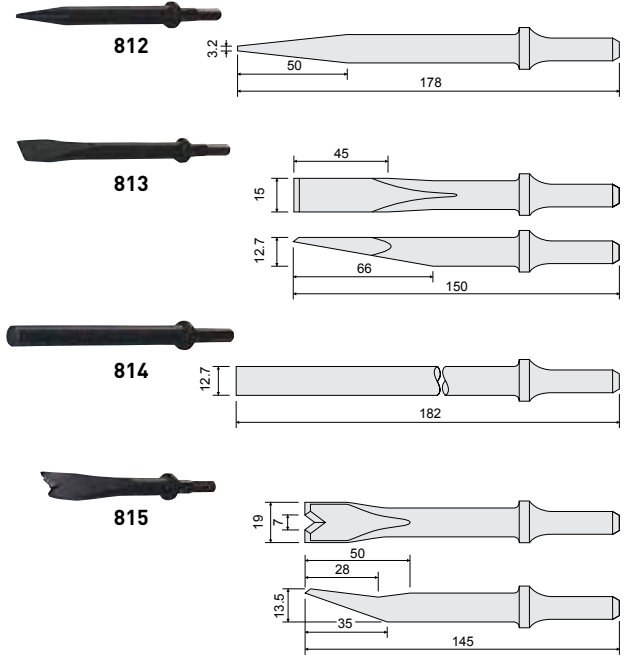
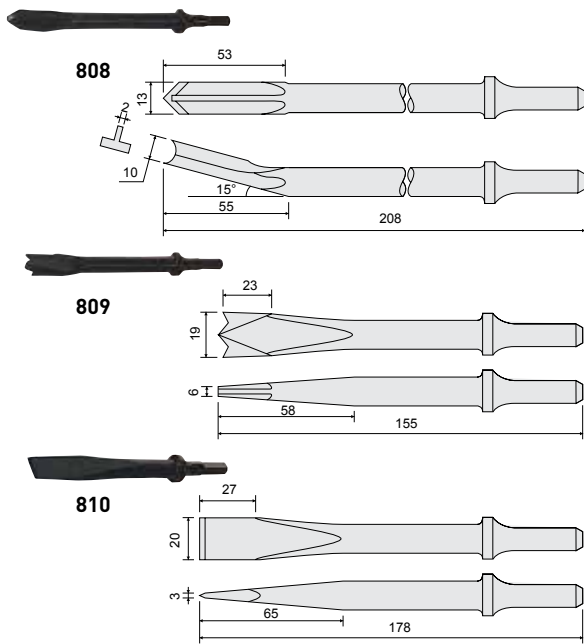

RETAINER FOR FRH AND FC-01SA SERIES



FC-01SA		FRH-3, 6		FRH-6A		Part Name
Item N°	Part Number	Item N°	Part Number	Item N°	Part Number	
H-043715-00	541 205 4377	H-019715-00	541 205 4323	H-024715-00	541 205 4349	Holder Spring
H-043719-00	541 205 4378	H-019719-00	541 205 4324	H-024719-01	541 205 4350	Holder Spring (B)

RIVET SNAPS FOR FRH SERIES

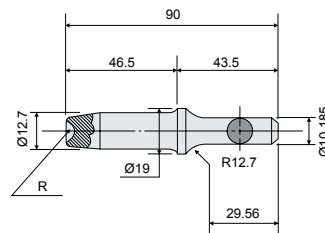

AC Number	Part Number	R Size		Rivet Size	
		mm	mm	mm	mm
SNAP-3	541 205 6237	3.0	3		
SNAP-4	541 205 6238	3.7	4		
SNAP-5	541 205 6239	4.8	5		
SNAP-6	541 205 6240	5.1	6		

CHISEL HOLDERS FOR FC SERIES

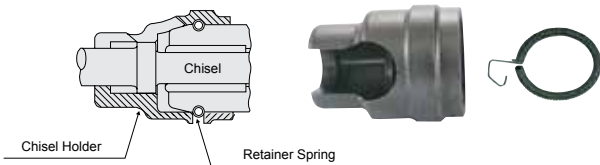

FC-01		FC-1Z~4Z		Part Name
Item N°	Part Number	Item N°	Part Number	
H-059714-00	541 205 4401	H-047714-01	541 205 4388	Chisel Holder
H-059761-00	541 205 4402	H-047761-00	541 205 4389	Retainer Spring

BUTTON-HEAD RIVET SNAPS FOR B SERIES

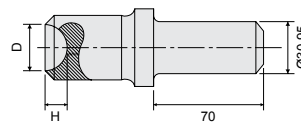

AC Number	Part Number	Button Head Rivet Rivet Diameter		Rivet Snap Dimensions (mm)	
		mm	in	D	H
SNAP-50	541 210 3631	10	3/8	15.8	6.5
SNAP-51	541 207 5531	13	1/2	20.5	8.3
SNAP-52	541 206 0309	16	5/8	25.5	10.2
SNAP-53	541 206 0310	19	3/4	29.5	12.5
SNAP-54	541 206 0311	22	7/8	34.5	14.4
SNAP-55	541 207 5535	25	1	39.5	16.2

PERCUSSIVE TOOLS

ACCESSORIES

CHISELS FOR FC-SERIES

CHISELS / MODELS REFERENCE

	Shape of Chisel Bush	
WJ-	Round	FC-01-4
WJB-	Hex	FC-01-3

	Shape of Chisel Bush	
WG-	Round	FC-1Z-2-4Z-2
WH-	Hex	FC-1Z-1-4Z-1

	Chisel End Shape
P	Point
F	Flat
SL	Scaling

CHISELS SHANK SIZE

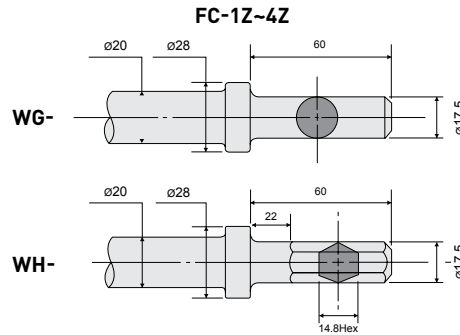
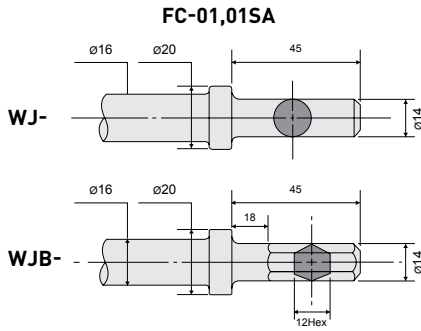

SHAPES OF CHISEL ENDS

BLANK CHISELS



AC Number	Part Number	Overall Length	Chisel Shank	Model
		mm		
WJ-8	541 205 8740	200	Round	FC-01-4 FC-01SA
WJ-10	541 205 8737	250		
WJ-12	541 205 8738	300		
WJ-16	541 205 8739	400		
WJB-8	541 205 8750	200	Hex	FC-01-3 FC-01SA
WJB-10	541 205 8744	250		
WJB-12	541 205 8748	300		
WJB-16	541 205 8749	400		
WG-10	541 205 8708	250	Round	FC-1Z-2- 4Z-2
WG-12	541 205 8712	300		
WH-10	541 205 8717	250	Hex	FC-1Z-1- 4Z-1
WH-12	541 205 8721	300		

FLAT CHISELS (F)

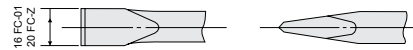

AC Number	Part Number	Overall Length	Chisel Shank	Model
		mm		
WJ-8F	541 205 8740	200	Round	FC-01-4 FC-01SA
WJB-8F	541 205 8740	200	Hex	FC-01-3 FC-01SA
WJB-10F	541 205 8740	250		
WG-8F	541 205 8740	200	Round	FC-1Z-2- 4Z-2
WG-10F	541 205 8740	250		
WH-8F	541 205 8740	200	Hex	FC-1Z-1- 4Z-1
WH-10F	541 205 8740	250		

POINT CHISELS (P)

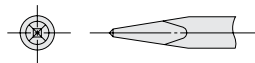

AC Number	Part Number	Overall Length	Chisel Shank	Model
		mm		
WJ-8P	541 205 8742	200	Round	FC-01-4 FC-01SA
WJB-8P	541 205 8752	200	Hex	FC-01-3 FC-01SA
WJB-10P	541 205 8746	250		
WG-8P	541 205 8715	200	Round	FC-1Z-2- 4Z-2
WG-10P	541 205 8710	250		
WH-8P	541 205 8728	200	Hex	FC-1Z-1- 4Z-1
WH-10P	541 205 8719	250		

SCALING CHISELS (SL)

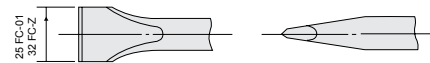

AC Number	Part Number	Overall Length	Chisel Shank	Model
		mm		
WJ-8SL	541 205 8743	200	Round	FC-01-4 FC-01SA
WJB-8SL	541 205 8753	200	Hex	FC-01-3 FC-01SA
WJB-10SL	541 205 8747	250		
WG-8SL	541 205 8716	200	Round	FC-1Z-2- 4Z-2
WG-10SL	541 205 8711	250		
WH-8SL	541 205 8729	200	Hex	FC-1Z-1- 4Z-1
WH-10SL	541 205 8720	250		

RUBBER BUTTS FOR FR-SERIES



Type	Part Number	Size			Model
		D	d	H	
		mm	mm	mm	
R-1	541 205 5532	51	11.8	60	FR-18B, 18L
R-1-1	541 205 5533	41	12.7	47	FR-18B, 18L
R-2	541 205 5534	51	13.75	60	FR-22B, 22L
R-3	541 205 5535	67	17.25	80	FR-25B, 25L
R-4	541 205 5536	75	18.75	92	FR-32

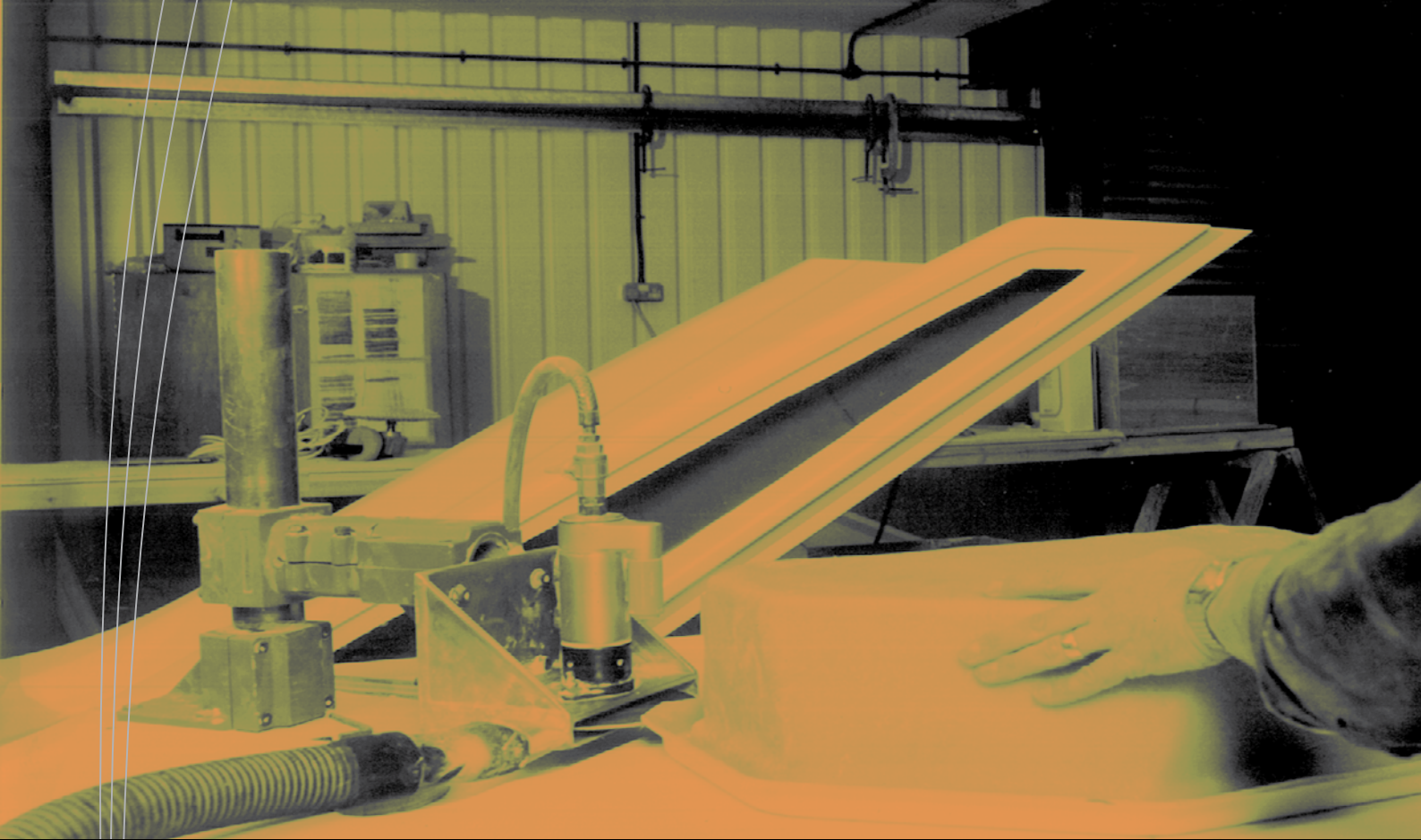

AIR MOTORS

REVERSIBLE / NON-REVERSIBLE TYPE _____ 92

AIR MOTORS

Fuji Air Motors are compact and light weight, yet sturdy and offer high power-to-weight ratios. Fuji offers a wide range of air motors from small 0.1 kW hand-held motor to large 20 kW stationary motor which are found at versatile industries like ships, chemical plants, mines and power plants etc. As air motors are less likely to generate sparks (unlike brushes in electric motors), they are better suited for use in hazardous environments. Please refer to your Fuji sales representative to get detailed air motor specifications and air diagram information.

REVERSIBLE TYPE



GLOBAL SPECIFICATIONS

Model	Stall Torque		Power		Free Speed	Overall Length		Weight		Air Consumption		Air Hose Size	
	N.m	ft.lb	W	PS	min ⁻¹	mm	in	kg	lb	m ³ /min	ft ³ /min	mm	in
F-5SM-8.5R	5.4	4	120	0.16	850	147	5.79	0.6	1.3	0.3	9.9	8	5/16
F-5SM-2R	21.6	15.9	100	0.13	190	182	7.16	0.8	1.8	0.3	12	6.3	1/4
F-6SM-12R	5.9	4.4	230	0.31	1000	157	6.18	0.8	1.8	0.3	12	8	5/16
F-6SM-21R	4	2.9	260	0.35	2000	146	5.75	0.9	2	0.3	12	8	5/16
F-6SM-28R	3.3	2.4	250	0.34	2300	146	5.75	0.8	1.8	0.5	17.7	8	5/16
F-6SM-8R	9.8	7.2	230	0.31	750	179	7.05	1	2.2	0.5	17.7	8	5/16
F-6SM-2.5R	26	19.2	210	0.28	250	192	7.56	1.2	2.6	0.3	12	8	5/16
F-6SM-5R	14.7	10.8	230	0.31	500	179	7.05	1	2.2	0.3	12	8	5/16
F-8SM-8.5R	14.7	10.8	370	0.5	850	222	8.74	1.5	3.3	0.3	17.7	9.5	3/8
F-8SM-12R	9.8	7.2	370	0.5	1100	199	7.83	2.2	4.8	0.5	17.7	9.5	3/8
F-8SM-28R	6.4	4.7	380	0.51	2300	183	7.2	1.5	3.3	0.5	17.7	9.5	3/8

TOOL SELECTION GUIDE

Standard models

Model	Type of spindle		
	Chord Type	Key type	Thread type (TH)
F-5SM-2R	541 205 2125		
F-5SM-8.5R	541 205 2130		
F-6SM-2.5R	541 205 2158		
F-6SM-5R	541 205 2173		
F-6SM-8R	541 205 2178		
F-6SM-12R	541 205 2153		
F-6SM-21R	541 205 2163		
F-6SM-28R	541 205 2168		
F-8SM-12R		541 205 2218	
F-8SM-28R		541 205 2220	
F-8SM-8.5R		541 205 2222	541 205 9075

CE certified models

Model	Type of spindle	
	Chord Type	Key type
F-5SM-2R	541 207 1036	
F-6SM-2.5R	541 207 1051	
F-6SM-5R	541 207 1056	
F-6SM-12R	541 207 1049	
F-6SM-21R	541 207 1052	
F-6SM-28R	541 207 1054	
F-8SM-8.5R		541 207 1063

For CE region availability of non CE models, please inquire to your Fuji representative.

NPT models

Model	Type of spindle	
	Chord Type	Key type
F-5SM-8.5R	541 205 2131	
F-6SM-2.5R	541 205 2159	
F-6SM-28R	541 205 2169	
F-6SM-8R	541 205 2179	
F-8SM-12R		541 205 2219

For possibility of NPT inlet for other models, please inquire to your Fuji representative.

NON-REVERSIBLE TYPE



GLOBAL SPECIFICATIONS

Model	Stall Torque		Power		Free Speed	Overall Length		Spindle Thread Size	Weight		Air Consumption		Air Hose Size	
	N.m	ft.lb	W	PS	min ⁻¹	mm	in	in	kg	lb	m ³ /min	ft ³ /min	mm	in
F-10MT	78.5	57.9	370	0.5	180	270	10.63	1/2-20UNF	3.4	7.5	0.6	22.3	9.5	3/8
F-6SE E	15.7	11.6	260	0.35	600	210	8.27	3/8-24UNF	1	2.2	0.4	14.8	9.5	3/8
F-6SF E	28.4	21	260	0.35	300	225	8.86	3/8-24UNF	1.1	2.4	0.4	15.2	9.5	3/8

Standard models

Model	Part Number
F-10MT	541 205 2051
F-6SE E	541 205 2147
F-6SF E	541 205 2149

Air Inlet Thread Size: PT 1/4"

*For application examples, please refer to the stirring propellers

NON-REVERSIBLE TYPE



F-5SM-8.5



F-6SM-2.5~28



F-5SM-2



F-8SMA-8.5~28

GLOBAL SPECIFICATIONS

Model	Stall Torque		Power		Free Speed	Overall Length		Weight		Air Consumption		Air Hose Size	
	N.m	ft.lb	W	PS	min ⁻¹	mm	in	kg	lb	m ³ /min	ft ³ /min	mm	in
F-5SM-2	23.5	17.4	120	0.16	200	187	7.36	0.9	2	0.3	9.9	6.3	1/4
F-5SM-8.5	5.9	4.4	130	0.17	950	153	6.02	0.6	1.3	0.3	9.9	6.3	1/4
F-6SM-12	7.4	5.5	290	0.39	1300	181	7.125	0.9	2	0.3	12	9.5	3/8
F-6SM-2.5	28.4	21	260	0.35	300	213	8.39	1.2	2.6	0.3	12	9.5	3/8
F-6SM-21	4.4	3.2	290	0.39	2400	167	6.57	0.8	1.8	0.3	12	9.5	3/8
F-6SM-28	3.9	2.9	290	0.39	2800	167	6.57	0.7	1.5	0.5	17.7	9.5	3/8
F-6SM-5	15.7	11.6	250	0.34	600	200	7.87	1	2.2	0.3	12	9.5	3/8
F-6SM-8	10.8	8	260	0.35	900	200	7.87	1	2.2	0.5	17.7	9.5	3/8
F-8SMA-12	11.8	8.7	440	0.59	1300	200	7.87	2	4.4	0.3	12	9.5	3/8
F-8SMA-28	5.9	4.4	440	0.59	2600	171	6.73	1.5	3.3	0.5	17.7	9.5	3/8
F-8SMA-8.5	16.7	12.3	440	0.59	900	208	8.19	2.2	4.8	0.5	17.7	9.5	3/8

TOOL SELECTION GUIDE

Standard models

Model	Type of Spindle		
	Chord Type	Key Type	Thread Type (TH)
F-5SM-2	541 205 2122		
F-5SM-8.5	541 205 2127		
F-6SM-2.5	541 205 2155		
F-6SM-5	541 205 2170		
F-6SM-8	541 205 2175		
F-6SM-12	541 205 2150		541 205 2152
F-6SM-21	541 205 2160		
F-6SM-28	541 205 2165		
F-8SMA-8.5		541 205 2230	541 205 2232
F-8SMA-12		541 205 2224	541 205 2226
F-8SMA-28		541 205 2227	541 205 2229

CE certified models

Model	Type of Spindle	
	Chord Type	Key Type
F-5SM-8.5	541 207 1037	
F-6SM-2.5	541 207 1050	
F-8SMA-28		541 207 1065

For CE region availability of non CE models, please inquire to your Fuji representative.

Type of Spindle

Chord Type	Key Type	Thread Type		
Model	Model	Model	Spindle Thread Size	Applicable Drill Chuck
F-5SM series F-6SM series	F-8SMA series F-8SM series	F-6SM-5, 8, 12, 21 F-8SMA-12, 28 F-6SE, 6SF, 6PFX	3/8-24(UNF)	DCK-6.5 DCK-8 DCK-10
		F-8SMA-8.5 F-10MT	1/2-20(UNF)	DCK-13

*Drill chucks are applicable to thread type spindle models.

Hose Connection

NON-REVERSIBLE TYPE



REVERSIBLE TYPE





COMPLEMENTARY RANGE

AIR FILES / AIR SAWS _____	96
CHAMFERING / ALUMINUM MILLING MACHINES _____	97
PIPE BEVELLING MACHINES _____	98
SUMP PUMPS / PISTON PUMPS _____	100
TIP DRESSERS _____	101
MARKING PEN / AIR CLEANERS _____	102

AIR FILES / AIR SAWS

Fuji FRF series compact Air File & Saws feature reduced vibration and are designed for deburring, filing and cutting of metal, wood, plastic, and fibreglass. The FRS-45 Air Saw is equipped with a damper to minimize vibration and, a stroke regulator and blade cooling device. The cutting direction is adjustable to provide optimal operator comfort.



FRF-4-1, 2



FRS-45

GLOBAL SPECIFICATIONS

Model	Tool Name	Stroke Per Minute SPM	Stroke		Chuck Capacity		Overall Length		Weight		Max. Air Consumption		Air Hose Size	
			mm	in	mm	in	mm	in	kg	lb	m ³ /min	ft ³ /min	mm	in
FRF-4-1	File	1600	12	0.47	4x13x20	5/32x1/2x25/32	229	9	0.8	1.7	0.3	9.9	6.3	1/4
FRF-4-2	Saw	1600	12	0.47	2x13x20	5/64x1/2x25/32	229	9	0.8	1.7	0.3	9.9	6.3	1/4
FRS-45	Saw	1200	45	1.77	2,5x17,7x31	3/32x45/64x1 7/32	421	16.6	2.9	6.4	0.4	14.1	8	5/16

Air Inlet Thread Size: PT1/4"

TOOL SELECTION GUIDE

Standard models

Model	Throttle	
	Lever	Locking Lever (F)
FRF-4-1 E	541 205 3371	541 205 3373
FRF-4-2 E	541 205 3375	541 205 3376
FRS-45	541 205 3402	

CE certified models

Model	Throttle	
	Lever	Locking Lever (F)
FRF-4-1F		541 207 2245
FRF-4-2F		541 207 2247
FRS-45	541 207 2280	

For CE region availability of non CE models, please inquire to your Fuji representative.

NPT models

Model	Throttle	
	Lever	Locking Lever (F)
FRF-4-1	541 210 2800	
FRS-45	541 205 3403	

For possibility of NPT inlet for other models, please inquire to your Fuji representative.

ACCESSORIES

FILE BLADES FOR FRF-4-1, 1F



Model	Tool Name	Part Number	Stroke Per Minute SPM	Stroke mm
1	•FILE-4P	541 205 2955	Pillar	150
2	•FILE-4H	541 205 2954	Half Round	
3	•FILE-4R	541 205 2956	Round	
4	•FILE-4C	541 205 2953	Triangle	
5	•FILE-4S	541 205 2957	Square	

* =Accessories included in FRF-4-1, 1F

SAW BLADE FOR FRF-4-2, 2F

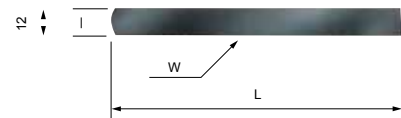

Model	Part Number	Stroke	
		L mm	mm
•SAW-4	541 205 6223	123	25

* =Accessories included in FRF-4-2, 2F.
* W =The number of teeth per inch.

SAW BLADES FOR FRS-45

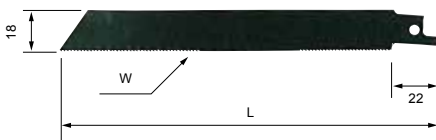

Item n°	Part Number	Size		Cutting Materials
		L mm	W	
SAW-2014	541 205 6216	200	14	steel plate, pipe, copper, brass, plastic, slate
•SAW-2018	541 205 6217	200	18	steel plate, pipe
•SAW-2024	541 205 6218	200	24	steel plate, pipe
•SAW-2514	541 205 6219	250	14	steel plate, pipe, copper, brass, plastic, slate
•SAW-2518	541 205 6220	250	18	steel plate, pipe
•SAW-3014	541 205 6221	300	14	steel plate, pipe, copper, brass, plastic, slate
•SAW-3018	541 205 6222	300	18	steel plate, pipe

* =Accessories included in FRS-45. W =The number of teeth per inch.

*Using cutting fluid extends life of blade. A mixture of turpentine and kerosene with spindle oil, *soapsuds, grease at the rate of 7 to 3 is recommended.

STANDARD ACCESSORIES FOR FRS-45



Item	Part Number	Description
SAW-2018	541 205 6217	Saw Blade (1) (min order unit 10)
SAW-2024	541 205 6218	Saw Blade (1) (min order unit 10)
F-704	541 205 2207	4mm Hex. Pin Wrench (1)
F-706	541 205 2209	6mm Hex. Pin Wrench (1)
AO-30	541 207 0161	Oil (1)
CASE-T431	541 205 1098	Steel Case (1)

CHAMFERING MACHINES

CHAMFERING MACHINES

Fuji Chamfering Machines are powerful and durable. They are ideal for chamfering edges of steel skeleton materials used in various industries such as ship building, bridge and steel frame construction. Pneumatically driven with easily replaceable carbide tips provide uniform and precise chamfering.



FBM-2-1

GLOBAL SPECIFICATIONS

Model	Chamfering Size		Max. Output		Rotational Frequency		Height		Weight		Air Consumption (Free Speed)		Air Hose Size	
	mm	W	hp	min ⁻¹	mm	in	kg	lb	m ³ /min	ft ³ /min	mm	in		
FBM-2-1 R4	4mm	900	1.2	10000	144	5.7	3.6	7.9	1.2	42.4	9.5	3/8		
FBM-2-1 K	2-4mm	900	1.2	10000	144	5.7	3.6	7.9	1.2	42.4	9.5	3/8		
FBM-2-1F R4	4mm	900	1.2	10000	144	5.7	3.7	8.2	1.2	42.4	9.5	3/8		
FBM-2-1F K	2-4mm	900	1.2	10000	144	5.7	3.7	8.2	1.2	42.4	9.5	3/8		

Standard models

Model	Throttle	
	Roll	Locking Lever (F)
FBM-2-1 R4	541 210 3288	541 210 3289
FBM-2-1 K	541 210 3316	541 210 3319

CE certified models

Model	Throttle	
	Roll	Locking Lever (F)
FBM-2-1F R4 EC	541 210 4325	
FBM-2-1F K EC	541 210 4324	

For CE region availability of non CE models, please inquire to your Fuji representative.

NPT models

Model	Throttle	
	Roll	Locking Lever (F)
FBM-2-1 R4 N	541 210 3835	541 210 3837
FBM-2-1 K N	541 210 3836	541 210 3838

For possibility of NPT inlet for other models, please inquire to your Fuji representative.

ACCESSORIES

Tips are not supplied with the tool. 3 tips are needed

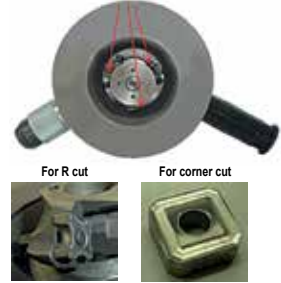

Size of chamfering	Description	Item No	Part Number
R2	Tip	X-027-10	541 205 8760
R3	Tip	X-025-003	541 205 8759
R4	Tip	S-181-001	541 210 3831
C2 to C4	Tip	X-027-13	541 205 8762
R2 or C2	Guide Roller	S-173698-01	541 205 6179
R3 or C3	Guide Roller	S-173698-00	541 205 6178
R4 or C4	Guide Roller	S-181698-00	541 210 3247

ALUMINUM MILLING MACHINES

Aluminum Milling Machines are ideal portable tools to remove weld beads flush to the work surface and "V" grooving for aluminum welds milling type rotary cutters. The high power motor supplied with speed control governor provides smooth milling. The tools feature easy depth adjustments, chip blowing, milling cutter cooling, slow start throttle, and center guide with roller for easy operation.

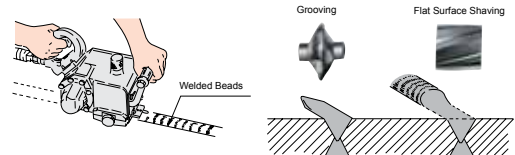

FRC-200-1

- Grooving cutter dia. 62 mm
- Flat surface shaving cutter dia. 50 mm



FRC-300-1

- Grooving cutter dia. 100 mm
- Flat surface shaving cutter dia. 61 mm

GLOBAL SPECIFICATIONS

Model	Max. Grooving Depth	Max. Cutter Width	Cutter Shaft Dia.	Power		Rotational Frequency	Overall Length		Weight		Max. Air Consumption		Air Hose Size	
	mm	mm	mm	W	PS	min ⁻¹	mm	in	kg	in	m ³ /min	ft ³ /min	mm	in
FRC-200-1	15.5	50	12	1250	1.7	7,000	295	11 39/64	4.7	10.3	1.4	49.4	12.7	1/2
FRC-300-1	30.0	50	15	2650	3.6	4,600	372	14 41/64	14.0	30.8	2.2	77.7	19.0	3/4

Air Inlet Thread Size: PT 3/8"

TOOL SELECTION GUIDE

Standard models

Model	Throttle	
	Roll	Lever
FRC-200-1	541 205 3245	
FRC-300-1	541 207 2126	

CE certified models

Model	Throttle	
	Roll	Lever
FRC-200-1 EC	541 207 2125	

For CE region availability of non CE models, please inquire to your Fuji representative.

NPT models

Model	Throttle	
	Roll	Lever
FRC-300-1	541 205 3247	

For possibility of NPT inlet for other models, please inquire to your Fuji representative.

ACCESSORIES

CUTTERS FOR FRC-200, 300 SERIES

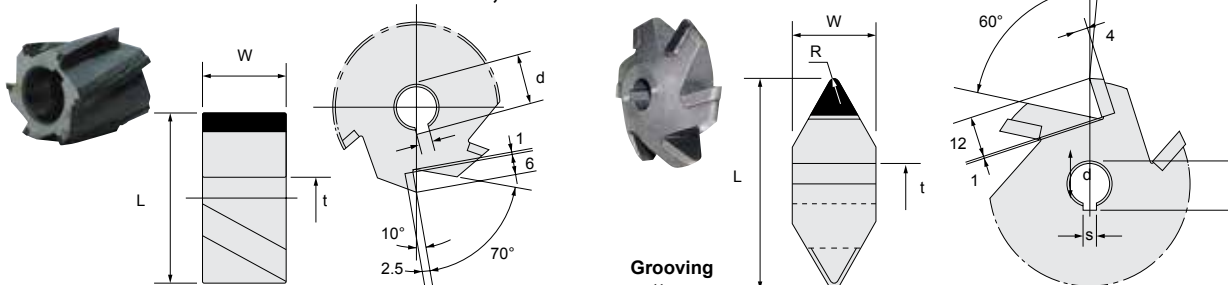

Flat surface shaving Cutter

AC Number	Part Number	Size (mm)					Models
		L	W	t	d	s	
CUT-0205	541 206 0307	50	25	12 \emptyset	13.7	4	FRC-200-1
CUT-0204	541 206 0306	60	51	15 \emptyset	17.3	5	FRC-300-1

Grooving cutter

AC Number	Part Number	Size (mm)						Models
		L	R	W	t	d	s	
CUT-0202	541 205 1225	62	3	25	12 \emptyset	13.7	4	FRC-200-1
CUT-0208	541 206 0308	100	4	42	15 \emptyset	17.3	5	FRC-300-1

PIPE BEVELLING MACHINES

Fuji Portable Pipe Beveling Machines feature a powerful motor, zero torque reaction, in-pipe chucking, and variable speed control to assure a precise and fast beveling operation. They are available with beveling capacities from 12 mm through 240 mm pipe inside diameter.



GLOBAL SPECIFICATIONS

Model and Assortment	Capacity (Pipe inside Dia.)		Stall Torque		Rotational Frequency	Feed Length		Side to Center		Overall Length		Weight		Max. Air Consumption		Air Hose Size	
	mm	in	N.m	ft.lb	min ⁻¹	mm	in	mm	in	mm	in	kg	lb	m ³ /min	ft ³ /min	mm	in
FBM-16-1	12 - 16 mm	15/32" - 5/8"	25	18.8	290	20	0.79	19.0	3/4	261	10.3	2.6	5.7	0.40	14.1	8	5/16
FBM-24-1	14 - 24 mm	35/64" - 15/16"	34.3	25.3	180	30	1.18	27.0	1 1/16	278	10.9	2.9	6.4	0.40	14.1	8	5/16
FBM-300-2	80 - 120 mm	3 9/64" - 4 23/32"	431	318	75	60	2.36	56.0	2 1/5	524	20.6	23.7	52.1	1.68	59.5	12.7	1/2
FBM-300-3	120 - 240 mm	4 23/32" - 9 29/64"	431	318	75	60	2.36	135.0	5 5/16	603	23.7	26.8	60	1.68	59.5	12.7	1/2
FBM-300-4	80 - 240 mm	3 9/64" - 9 29/64"	431	318	75	60	2.36	135.0	5 5/16	603	23.7	26.8	59.1	1.68	59.5	12.7	1/2
FBM-80A-2	30 - 40 mm	1 3/16" - 1 9/16"	113	83.3	100	30	1.18	39.0	1 11/20	403	15.9	6.7	14.3	0.60	21.1	8	5/16
FBM-80A-3	40 - 80 mm	1 9/16" - 3 1/8"	113	83.3	100	30	1.18	39.0	1 11/20	403	15.9	6.7	14.7	0.60	21.1	8	5/16
FBM-80A-4	30 - 80 mm	1 3/16" - 3 1/8"	113	83.3	100	30	1.18	39.0	1 11/20	403	15.9	6.7	14.7	0.60	21.1	8	5/16
FBM-80A-5	20 - 29 mm	2 5/32" - 1 5/32"	113	83.3	100	30	1.18	39.0	1 11/20	403	15.9	6	13.2	0.60	21.1	8	5/16
FBM-80A-6	20 - 80 mm	2 5/32" - 3 1/8"	113	83.3	100	30	1.18	39.0	1 11/20	403	15.9	6.7	14.8	0.60	21.1	8	5/16

*FBM-16, 24, 80A: 1/4" Air inlet thread. FBM-300: 1/2" Air Inlet thread.
 *Optional Chuck Ass'y. for 240~300 mm Pipe Beveling is also available on request.

TOOL SELECTION GUIDE

Standard models

Model	Handle	
	Normal roll handle	Self return type (S)
FBM-16-1	541 205 2419	541 205 2421
FBM-24-1	541 205 2423	541 205 2425
FBM-80A-1	541 207 1197	541 205 2441
FBM-80A-2	541 205 2443	
FBM-80A-3	541 205 2447	541 205 2449
FBM-80A-4	541 205 2451	541 205 2453
FBM-80A-5	541 205 2455	
FBM-80A-6	541 205 2459	541 205 2461
FBM-300-2	541 205 2427	
FBM-300-3	541 205 2431	
FBM-300-4	541 205 2435	

CE certified models

Model	Handle
	Self return type (S)
FBM-24-1S	541 207 1196
FBM-80A-1S	541 207 1198
FBM-80A-3S	541 207 1199
FBM-80A-4S	541 207 1200
FBM-80A-6S	541 207 1201

For CE region availability of non CE models, please inquire to your Fuji representative.

NPT models

Model	Handle	
	Normal roll handle	Self return type (S)
FBM-80A-4	541 205 2452	
FBM-80A-6S		541 205 2462

For possibility of NPT inlet for other models, please inquire to your Fuji representative.

FULL SET
FBM-16-1(S)



FULL SET
FBM-24-1(S)



FULL SET
FBM-80A-6(S)



FULL SET
(4 CASES)
FBM-300-4(S)

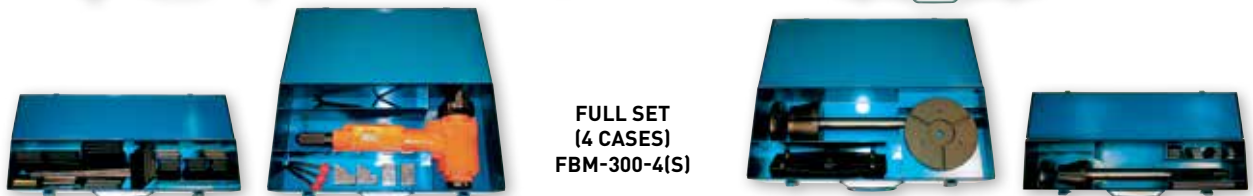

ACCESSORIES

CHUCKS PROVIDED FOR FBM-16, 24, 80A AND 300
 FBM-16, 24, 80A, 300

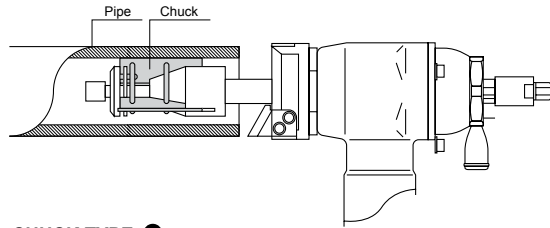
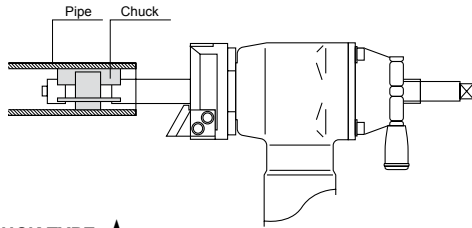

CHUCK TYPE ★



FBM-16-1
 FBM-24-1
 FBM-80A (20mm~29mm)

CHUCK TYPE ●



FBM-80A (30mm~80mm)
 FBM-300 (240mm)
 3 pcs are necessary for each size

FBM-16-1, 1S ★

Item N°	Part Number	Pipe size mm
S-138638-00	541 205 5918	12-16
S-138638-01	541 205 5919	14-16
S-138638-03	541 207 5330	18-20

FBM-24-1, 1S ★

Item N°	Part Number	Pipe size mm
S-120638-10	541 205 5863	14-16
S-120638-11	541 205 5864	16-18
S-120638-12	541 205 5865	18-20
S-120638-13	541 205 5866	20-22
S-120638-14	541 205 5867	22-24

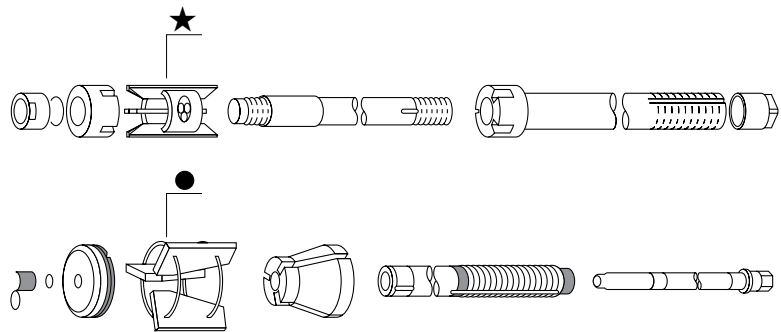

FOR FBM-80A ★●

Models	Item N° S-121638-xx			Item N° S-162638-xx						
	-00 20-23 mm	-01 23-26 mm	-02 26-29 mm	-00 30-35 mm	-01 35-40 mm	-02 40-48 mm	-03 48-56 mm	-04 56-64 mm	-05 64-72 mm	-06 72-80 mm
541 205 5891	541 205 5892	541 205 5892	541 205 5892	541 205 6060	541 205 6061	541 205 6062	541 205 6063	541 205 6064	541 205 6065	541 205 6066
-2(30~40mm)	-	-	-	●	●	-	-	-	-	-
-3(40~80mm)	-	-	-	-	-	●	●	●	●	●
-4(30~80mm)	-	-	-	●	●	●	●	●	●	●
-5(20~29mm)	★	★	★	-	-	-	-	-	-	-
-6(20~80mm)	★	★	★	-	●	●	●	●	●	●

FOR FBM-300 ●

Models	Item N° S-158638-xx														
	-00 80-90 mm	-01 90-100 mm	-02 100-110 mm	-03 110-120 mm	-04 120-130 mm	-05 130-140 mm	-06 140-150 mm	-07 150-160 mm	-08 160-170 mm	-09 170-180 mm	-10 180-190 mm	-11 190-200 mm	-12 200-210 mm	-13 210-220 mm	-14 220-230 mm
541 205 5892	541 205 5893	541 205 5894	541 205 5895	541 205 5896	541 205 5897	541 205 5898	541 205 5899	541 205 6000	541 205 6001	541 205 6002	541 205 6003	541 205 6004	541 205 6005	541 205 6006	541 205 6007
-2(80~120mm)	●	●	●	●	-	-	-	-	-	-	-	-	-	-	-
-3(120~240mm)	-	-	-	-	●	●	●	●	●	●	●	●	●	●	●
-4(80~240mm)	●	●	●	●	●	●	●	●	●	●	●	●	●	●	●

STANDARD BIT TOOLS

Bit Tool Shape	Item N°	Part Number	Dimensions (mm)				Models
			(Q)	a	b	Thickness	
For Exterior Beveling							
	BIT-016E01	541 205 1066	30°	12	25	6.0	FBM-16
	BIT-024E01	541 205 1068	30°	14	30	8.0	FBM-24
	BIT-042E02	541 205 1073	37.5°	35	56	11.5	FBM-80A, 300
	BIT-042E03	541 205 1074	45°	25	50	11.5	
	BIT-042E06	541 205 1076	30°	25	40	11.5	FBM-300
	BIT-042E01	541 207 0284	30°	35	50	11.5	
	BIT-120E01	541 205 1080	30°	60	60	11.5	
For Interior Beveling							
	BIT-024B06	541 205 1072	30°	14	30	8.0	FBM-24
	BIT-042B01	541 205 1070	30°	25	40	11.5	FBM-80A, 300
	BIT-042B02	541 205 1071	45°	25	50	11.5	
For Surface Beveling							
	BIT-024F01	541 205 1069	-	14	25	8.0	FBM-24
	BIT-042F02	541 205 1078	-	25	30	11.5	FBM-80A, 300
	BIT-120F01	541 205 1081	-	60	40	11.5	FBM-300

*Bit Tools provided: **FBM-16:** Bit-016E01. **FBM-24:** BIT-024E01, 024F01
FBM-80A: BIT-042E06, 042F02 **FBM-300:** BIT-120E01, 120F01

*Other sizes of Bit Tool are available. Specify dimensions when ordering.

SUMP PUMPS / PISTON PUMPS

SUMP PUMPS

Fuji Sump Pumps are indispensable for discharging water, oil, sewage and sludge from sumps, trenches, manholes, bilges and tanks. They may be used in non-spark environments and their housing are rust-proof.



FP-7-2



FP-20-1



FP-35-1

GLOBAL SPECIFICATIONS

Model	Capacity				Water Output Thread Size	Air Outlet Thread Size	Height		Weight		Max. Air Consumption		Air Hose Size	
	Head		Discharge				PT	mm	in	kg	lb	m ³ /min	ft ³ /min	mm
FP-7-2	15	49	4.2	70	PT3/4	PT3/4	234	9.25	4.3	9.4	0.8	28.2	9.5	3/8
FP-20-1	20	66	28.0	467	W82.5-5	PT1	374	14.75	22	48.4	3.4	120	19	3/4
FP-35-1	28	92	28.0	467	W82.5-5	PT1/4	410	16.140625	34	74.8	5.2	184	25.4	1

TOOL SELECTION GUIDE

Standard models

Model	Part Number
FP-7-2	541 205 3111
FP-20-1	541 205 3107
FP-35-1	541 205 3109

CE certified models

Model	Part Number
FP-7-2	541 207 2034
FP-20-1	541 207 2031
FP-35-1	541 207 2033

For CE region availability of non CE models, please inquire to your Fuji representative.

PUMPING PERFORMANCE CURVE

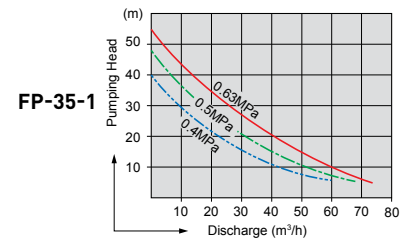
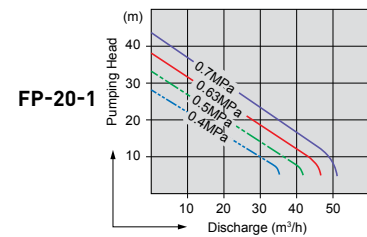
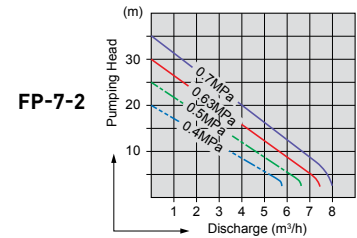

PISTON PUMPS



FP-11-1



FP-11-2

Fuji Piston Pumps FP-11 series are ideal pumps for pumping oil out from tanks and bilges in the vessels. Various flanges are optionally available for hose connection.

PUMPING PERFORMANCE CURVE

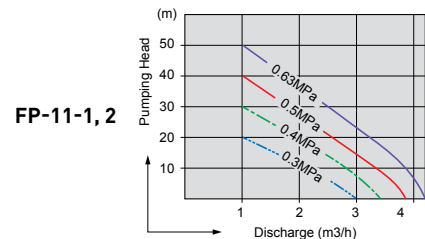

GLOBAL SPECIFICATIONS

Model	Discharge Volume		Piston Diameter		Stroke		Stroke N°	Overall Length		Weight		Max. Air Consumption		Air Hose Size	
	m ³ /h		mm	in	mm	in		Hz	mm	in	kg	lb	m ³ /min	ft ³ /min	mm
FP-11-1	0.0		48	1.9	100	4		622	24.5	4.7	10.3	0.2	7.1	9.5	3/8
FP-11-2	0.0		48	1.9	100	4		622	24.5	7.8	17.2	0.2	7.1	9.5	3/8

TOOL SELECTION GUIDE

Standard models

Model	Part Number
FP-11-1	541 205 3103
FP-11-2	541 205 3105

CE certified models

Model	Part Number
FP-11-1	541 207 2029

For CE region availability of non CE models, please inquire to your Fuji representative.

NPT models

Model	Part Number
FP-11-2	541 205 3106

For possibility of NPT inlet for other models, please inquire to your Fuji representative.

TIP DRESSERS

Fuji Tip Dresser FTD-18 series are designed to be compact, light weight and ideal for dressing tips in narrow space between opposing tips on electric spot welders. FTD-18A clamp system provides excellent tip center alignment and accurate tip repairing. Various types of welding tips can be dressed by replacing cutter and cutter case.



FTD-18-1



FTD-18A-1

GLOBAL SPECIFICATIONS

Model	Capacity Tip Size		Max. Clamp Height		Free Speed min ⁻¹	Overall Length		Weight		Max. Air Consumption		Air Hose Size	
	mm	in	mm	in		mm	in	kg	lb	m ³ /min	ft ³ /min	mm	in
FTD-18-1	12 - 16	0.47 - 0.63	-	-	1300	290	11.42	1.65	3.64	0.50	17.66	9.5	3/8
FTD-18A-1	13 - 16	0.51 - 0.63	25	0.98	1300	307	12.09	2.02	4.45	0.50	17.66	9.5	3/8

Air Inlet Thread Size: PT 1/4".

TOOL SELECTION GUIDE

Standard models

Model	Inside Diameter of cutter case		
	16	13	12
FTD-18-1	541 205 3495	541 205 3497	
FTD-18A-1	541 205 3501	541 205 3503	541 205 3502

CE certified models

Model	Inside Diameter of cutter case		
	16	13	12
FTD-18-1	541 207 2345	541 207 2344	
FTD-18A-1	541 207 2348	541 207 2347	541 207 2346

For CE region availability of non CE models, please inquire to your Fuji representative.

NPT models

Model	Inside Diameter of cutter case
	16
FTD-18-1	541 205 3499
FTD-18A-1	541 205 3505

For possibility of NPT inlet for other models, please inquire to your Fuji representative.

ACCESSORIES

CLASSIFICATION TABLE FOR CUTTERS

Type	Item N°	Part Number	Tip shape (Normal)	Max. diameter repaired (ØD)	Standard
(1)	CUT-1001	541 206 0307	6R	ø12	6R x ø12
	CUT-1002	541 205 0853	6.5R	ø13	6.5R x ø13
	CUT-1003	541 205 0854	8R	ø16	8R x ø16
(2)	CUT-2001	541 205 0855			16R x ø16
	-		10R~150R	ø16	-
(3)	-		øA x 6R	ø12	-
	-		øA x 6.5R	ø13	-
	CUT-3001	541 205 0856			ø5 x 8R x ø16
	CUT-3002	541 205 0857	øA x 8R	ø16	ø6 x 8R x ø16
(4)	-		r x øA x 6R	ø12	-
	CUT-1002	541 205 1227	r x øA x 6.5R	ø13	-
	CUT-1003	541 205 1228	r x øA x 8R	ø16	40r x ø6 x 8R x ø16
(5)	-		5~6r x 60°	ø13	-
	-		3r or more x 90°	ø16	-
(6)	-		7~ø9 x 50°	ø13	-
	-		ø10 or more x 50°	ø16	-
	CUT-6001	541 205 9009	5~ø7 x 60°	ø13	ø6 x 60° x ø13
	-		ø8 or more x 60°	ø16	-
	-		3~ø4 x 75°	ø13	-
	CUT-6002	541 205 9010	ø5 or more x 75°	ø16	ø6 x 75° x ø16
	CUT-6003		ø3 or more x 90°	ø16	ø4 x 90° x ø16
	CUT-6004	541 205 9012	ø3 or more x 90°	ø16	ø6 x 90° x ø16
	-		ø3 or more x 120°	ø16	-
	-		r x øA x'	øD	-
(7)	-		øA x r x'	øD	-
(8)	-		F	ø16	-
(9)	-				-

*Beside item listed above table, minimum 10pcs. per item is required for ordering optional cutters. Specify the nominal dimensions when ordering.

*Cutter is not provided as a standard accessory.

CUTTER CASES



Item N°	Part Number	ØD
S-167716-00	541 205 6123	16
S-167716-01	541 205 6124	13
S-167716-02	541 205 6125	12

*Cutter dresses Welding Tip correctly as inside diameter (dia. D) of cutter case act as a guide. Specify cutter case diameter which matches tip size. dia. 16 cutter case is included as a standard accessory. Specify cutter case dia. 12 or dia. 13 otherwise.

SHAPES OF TIPS AND CUTTERS

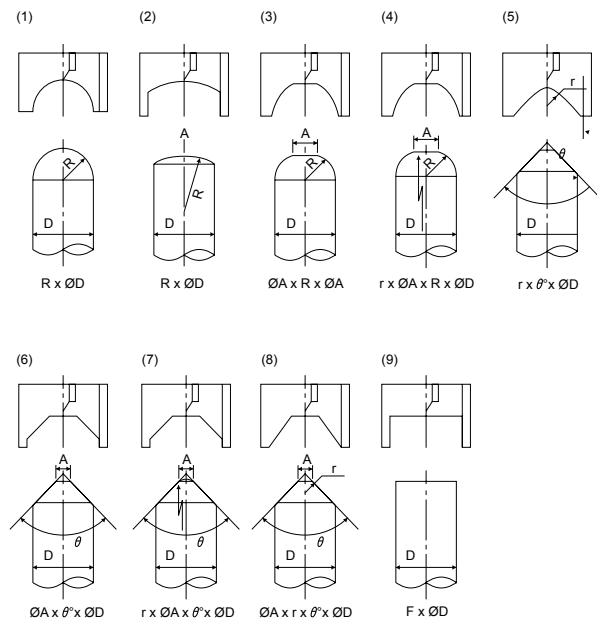

<FTD-18A-1> PAT.P

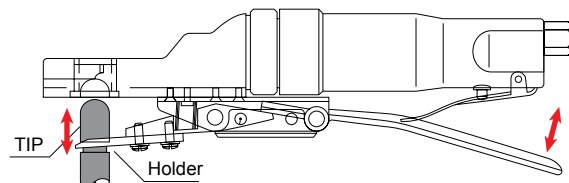

MARKING PEN / AIR CLEANERS

MARKING PEN

Fuji Marking Pen features a lower vibration level when compared to conventional marking pens enabling operators to use this tool for a full working day. This tool also requires no lubrication and meets requirements where oil free operation is specified.



GLOBAL SPECIFICATIONS

Model	Diameter		Overall Length		Weight		Air Consumption (at Load)	
	mm	in	mm	in	kg	lb	m ³ /min	ft ³ /min
G-400	20	0.787	140	5.51	0.15	0.331	0.03	1.06

TOOL SELECTION GUIDE

Standard models

Model	Part Number
G-400 E	541 205 4219

CE certified models

Model	Part Number
G-400 EC	541 207 2802

For CE region availability of non CE models, please inquire to your Fuji representative.

AIR CLEANERS

Fuji air cleaners remove dust, chips, sawdust, water and oil with their powerful vacuum action.



GLOBAL SPECIFICATIONS

Model	Vacuum Degree		Overall Length		Outside Dia. of Discharge	Weight		Max. Air Consumption		Air Hose Size	
	mm Hg	in Hg	mm	in		kg	lb	m ³ /min	ft ³ /min	mm	in
AC-200F	130	5.125	145	5.7	34	0.5	1.1	0.60	21.2	9.5	3/8
FJP-500	200	7.875	1020	40.1	37.5	1.5	3.3	0.60	38.8	9.5	3/8

Air Inlet Thread Size: PT : 1/4 for AC-200F - FJP-500 : 3/8.

TOOL SELECTION GUIDE

Standard models

Model	Part Number
AC-200F	541 205 0850
FJP-500 E	541 205 2961

CE certified models

Model	Part Number
AC-200F EC	541 207 0144
FJP-500 EC	541 207 1642

For CE region availability of non CE models, please inquire to your Fuji representative.

NPT models

Model	Part Number
FJP-500 N	541 205 2960

For possibility of NPT inlet for other models, please inquire to your Fuji representative.

ACCESSORIES

ACCESSORIES PROVIDED FOR AC-200F



Index N°	AC n°	Part Number	Name
1	ACB-1F	541 205 0852	Main Nozzle
2	ACB-2F	541 205 0853	Fan Shape Nozzle
3	ACB-3F	541 205 0854	Small-Size End Nozzle
4	ACB-4F	541 205 0855	Flexible Hose
5	ACB-5F	541 205 0856	Rubber Joint
6	ACB-6F	541 205 0857	Dust Bag
7	ACB-7F	541 205 0858	Hose Band

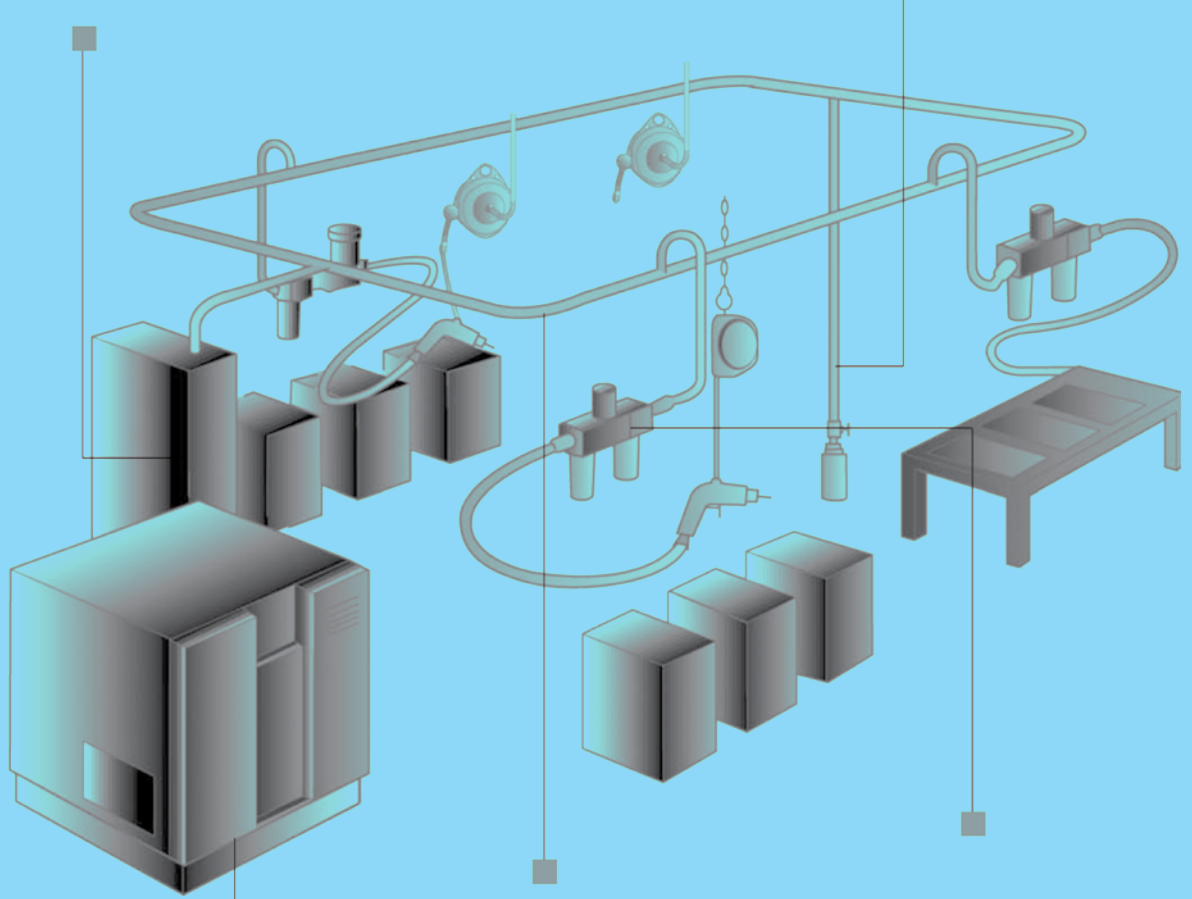

SERVICE TOOLING

SPANNERS AND WRENCHES FOR MAINTENANCE _____	104
AIR COMPRESSOR / AIR PRESSURE _____	105

SPANNERS AND WRENCHES FOR MAINTENANCE

OPEN-END WRENCHES

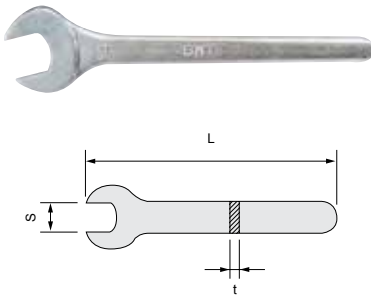

AC Number	Part Number	Size			Models
		S mm	L mm	t mm	
F-100	541 207 0992	5.5	81	2.5	FBM-2-1, 1F
F-101	541 205 2052	8.0	80	3.0	FG-13, 13X, TURBO-100
F-102	541 205 2053	9.5	80	1.5	FCD-6A, 6B
F-103	541 205 2054	10.0	80	3.0	FRD-5P-1, 5S-1, 1F, 6PX-2, 3, 5, *F-6SM-12, 21, 28, 28R, FRD-6S-2, 3, 5
F-103-1	541 207 0993	10.0	105	4.0	FBM-16, 24
F-104	541 205 2055	12.0	88	3.0	FG-12U, 12UX, 25D, 25DX, 50D, 50DX, FRD-8PX-1, 2, *F-5SM-2, 8.5, *8SMA-12, 28
F-105	541 205 2056	14.0	100	3.0	FG-12U, 12UX, 2VX-1F, 3VX-1F, 6F, 25D, 25DX, 50DX, 26, 26X, 50X, 50D, FA-2C, 2CX, TURBO-100A, FRD-6PX-7, 6S-7, 7F, 8PX-3, *F-6SM-2.5, 2.5R, *5, 8, F-6SE, 6SF, *8SM-8.5RA, *8SMA-8.5, 6PFX
F-106	541 205 2057	17.0	130	3.0	FRD-16Z, FCD-6X, F-10MT
F-117-1	541 207 0994	17.0	150	6.0	FBM-300
F-107	541 205 2058	19.0	130	3.0	FCD-10X, FA-2C, 2CX, FT-8PX, FBM-80A
F-117	541 205 2066	21.0	180	5.0	FG-3H, 3HL, 4HL, 50L, 50Y
F-109	541 205 2060	24.0	200	4.0	FA-5E-3 Series, 7E-5, 6, 8 Series, FV-7, 9BH-1M, FX-027-1, FA-6C-6M, 8M, 9M, 9C-4, 4M
F-110	541 205 2061	26.0	170	4.5	FA-150KG-5, 7, FA-5E-1, 2, 8, 13 Series, FA-7E-1, 2, 3 Series, 6C-1, 10, 12, 12M, 20, 9C-2, 2M, 7C-21
F-111	541 205 2062	27.0	170	4.5	FG-5PX, FD-4, 4P
F-112	541 205 2063	32.0	170	4.5	FG-3VX-2F, 3F, 4H, 4VA, 5HL, FA-4C, 4CH, 4CHK-1, FD-5, 5P
F-113	541 205 2064	41.0	180	4.0	FV-9BH-4M, FRC-300-1

* = Thread Spindle type

HOOK SPANNERS

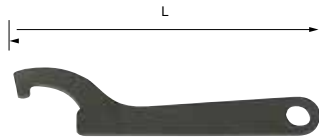

AC Number	Part Number	Size		Models
		S mm	L mm	
F-401	541 205 2118	130	2	FD-4P, 4
F-402	541 205 2119	160	2	FD-5P, 5
F-404	541 205 2120	135	4.5	FA-3C, 3CX
F-405	541 205 2121	170	4.5	FA-150K-20,30

ANGLE WRENCH

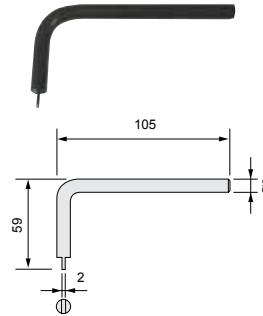

AC Number	Part Number	Models
F-601	541 205 2180	FD-5, 5P

OPEN-END PIN WRENCHES

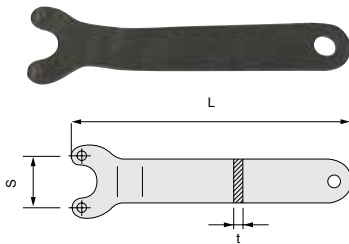

AC Number	Part Number	Size			Models
		S mm	L mm	t mm	
F-201	541 205 0853	16	130	4.0	FG-5PX
F-202	541 205 0854	30	160	4.5	FV-9BH-4M
F-203	541 205 0855	32	180	4.5	FA-6C, 9C, 5E-13 Series, 7E-5, 6, 8 Series, FV-7-1M, 2M, 4M, 9BH-1M

HEXAGONAL PIN WRENCHES

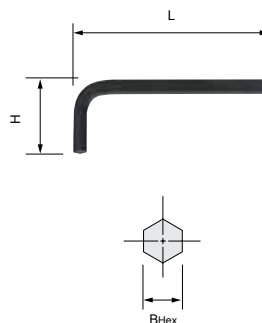

AC Number	Part Number	Size			
		B(Hex) mm	in	L mm	H mm
F-701-2	541 207 1057	1.27	-	45	10
F-701	541 205 2203	1.5	-	52	12
F-701-1	541 205 2204	1.5	-	52	52
F-712	541 205 2213	2.0	-	58	12
F-702-1	541 205 2208	2.0	-	60	60
F-702	541 205 2205	2.5	-	60	15
F-703	541 205 2206	3.0	-	65	20
F-704	541 205 2207	4.0	-	72	25
F-705	541 205 2208	5.0	-	80	28
F-706	541 205 2209	6.0	-	90	32
F-707	541 205 2210	-	1/4	90	32
F-708	541 205 2211	8.0	-	100	36
F-710	541 207 1058	-	3/8	112	40
F-709	541 205 2212	10.0	-	112	40

HEXAGONAL WRENCHES

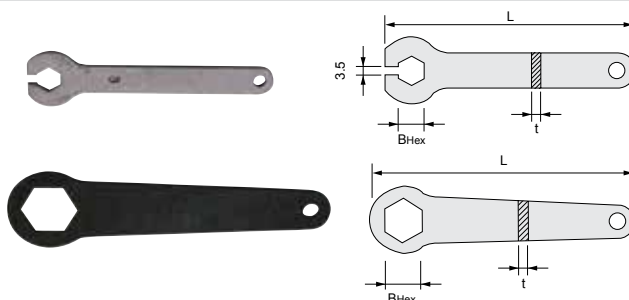

AC Number	Part Number	Size			Models
		B(Hex) mm	L mm	t mm	
F-301	541 205 2100	8	80	3	TURBO-100, FG-06-1, 06S-1, 13, 13X
F-304	541 205 2103	9	100	3	FG-06-1, 06S-1
F-306	541 205 2104	14	101	4	TURBO-100A
F-302	541 205 2101	17	135	2	FD-4P, 4
F-303	541 205 2102	21	138	2	FD-5P, 5

AIR COMPRESSOR / AIR PRESSURE

AIR COMPRESSOR

The capacity of an air compressor should be higher than the number of air tools in operation. In other words, when the respective factors are represented by the following signs, the expression should be $Q > Nq + a$.

- Q** : Capacity of Air Compressor
- q** : Air Consumption of Each Tool
- a** : Air Leakage in Piping
- N** : Number of Air Tools

The power of an air compressor necessary to compress air of 1 m³/min at the air pressure of 0.63 MPa is theoretically calculated at 4.44 kW (6 PS). But, the required power of an air compressor comes to 7.4 kW (10 PS) to 11.1 kW (15 PS) depending on the types of compressors (reciprocating or screw compressors) when the actual efficiency of an air compressor is taken into account. For instance, what capacity of an air compressor is required if 1 piece of FA-7C-4 angle grinder is used? Air of 1.4 m³/min is necessary to use 1 piece of FA-7C-4 angle grinder and the required power of an air compressor is calculated at 10.36 kW (14 PS) to 15.54 kW (21 PS). If 20 pieces of FA-7C-4 angle grinders are used at the same time, air of 19.6 m³/min is necessary and the required power of an air compressor is calculated at 145.0 kW to 217.6 kW (196 PS to 294 PS). Even if the number of tools changes, the required power of an air compressor can be obtained by simple calculation. Yet, when a number of air tools are used at the same time,

it does not seem that all the air tools are concurrently used at the maximum air consumption, so the following expression is given under our past experience.

- Air Tools : **A, B, C...**
- Number of Air Tools : **Na, Nb, Nc...**
- Air Consumption of Each Tool : **Ca, Cb, Cc...**
- Coefficient according to Number of Air Tools : **F**
- Total Air Consumption : **Q**

$$Q = F (Na \times Ca + Nb \times Cb + Nc \times Cc + \dots)$$

The coefficient is given as per the under-mentioned table according to the number of air tools. The coefficient is in inverse proportion to the number of air tools.

Number of Air tools	1-5	6-10	11-20	21-30	31-50	51-100
F	1.0	0.8	0.7	0.6	0.5	0.4

Those coefficients are obtained because air tools are not always in successive operation. It is usual that operations of air tools are intermitted for changing jobs, lubrication, changing grinding wheel, drill bit, chisel, etc. There is a case that even small capacity of an air compressor can be available due to an interval of jobs when such air tools as impact wrenches, screw drivers, etc. are in operation. The running time of those air tools for one job is 2 to 5 seconds and they are not used in succession for one job.

AIR PRESSURE

Air pressure should be maintained at less than the recommended air pressure at the inlet of the air tool. Our air tools are usually designed to be used at the air pressure of 0.63 MPa and the fluctuation of air pressure affects the performance of the air tool. For instance, if the power of an air tool is 0.74 kW (1 PS) at the air pressure of 0.63 MPa, the power of the air tool generally comes to the following figures at each air pressure.

Air Pressure (MPa)	0.70	0.63	0.50	0.40	0.30
Power (kW)	0.93	0.74	0.56	0.40	0.26

It should be taken into account that air pressure drops at the inlet of the air tool due to the resistance and leakage caused when air passes in the pipe even if the air pressure is 0.63 MPa at the outlet of the air compressor. Needless to say, the loss of power may be caused unless the appointed air hose is used.

On the contrary, when air pressure fluctuates higher than the recommended air pressure at the inlet of the air tool, parts may consume comparatively faster, and what is worse, accidental operations may be induced, so air pressure should be maintained at less than the recommended air pressure at the inlet of the air tool in any case.

ASSEMBLY TOOLS

Fig 01

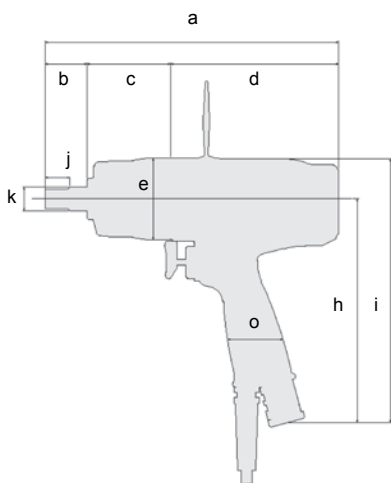
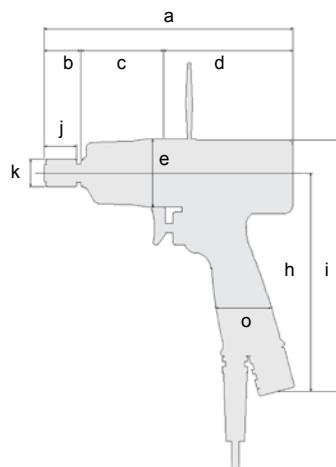

Fig 02



PULSE WRENCH

Non Shut-off type (square)

Fig N°	Model	a	b	c	d	e	h	i	j	k	o
01	FET-4-1	161,5	23,5	54	84	44	142	164	12	12	40
01	FET-5-1	161,5	23,5	54	84	44	142	164	12	12	40
01	FET-6-1	173,5	23,5	59	91	44	142	164	12	12	40
01	FET-7-1	177	23,5	52	101,5	48	145	168	12	12	40
01	FET-9-1	195	28	55,5	111,5	54	148	175	16,5	16	40
01	FET-11-1	206,5	28	66	112,5	59	157	185	16,5	16	45
01	FET-13-1	216,5	28	69,5	119	64	159	190	16,5	16	45
01	FET-16-1	262	35,5	88,5	138	82	217	269	24	25	55

PULSE WRENCH

Non Shut-off type (bit shank)

Fig N°	Model	a	b	c	d	e	h	i	j	k	o
02	FET-4D-1	162	24	54	84	44	142	164	21	18	40
02	FET-5D-1	162	24	54	84	44	142	164	21	18	40
02	FET-6D-1	174	24	59	91	44	142	164	21	18	40

Fig 01

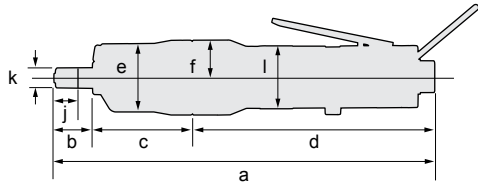
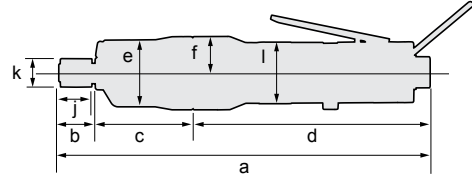

Fig 02



PULSE WRENCH

Non Shut-off type

Fig N°	Model	a	b	c	d	e	f	j	k	l
01	FL-4S-1	209	23,5	35,5	150	44	22	12	12	40
01	FL-5S-1	209	23,5	35,5	150	44	22	12	12	40
01	FL-6S-1	221	23,5	40,5	157	44	22	12	12	40
02	FL-4SD-1(10)	209,5	24	35,5	150	44	22	21	18	40
02	FL-5SD-1(10)	209,5	24	35,5	150	44	22	21	18	40
02	FL-6SD-1(10)	221,5	24	40,5	157	44	22	21	18	40

Fig 01

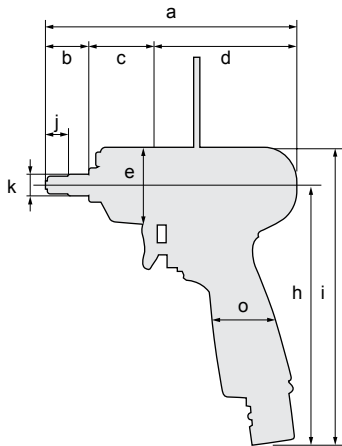
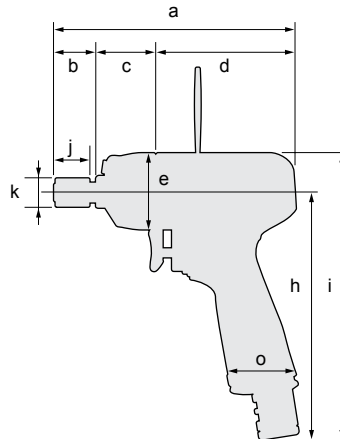

Fig 02



PULSE WRENCH

Non Shut-off type (square)

Fig N°	Model	a	b	c	d	e	h	i	j	k	o
01	FL-4-1	139.5	23.5	35.5	80.5	44	144	169	11	12	39
01	FL-5-1	139.5	23.5	35.5	80.5	44	144	169	11	12	39
01	FL-6-1	151.5	23.5	40.5	87.5	44	144	169	11	12	39
01	FL-7-1	157.0	24.5	53.0	79.5	51	147	173	12	12	39
01	FL-9-1	175.0	29.0	59.5	86.5	51	150	179	17	16	40
01	FL-11-1	184.5	29.0	64.5	91.0	65	160	191	17	16	44
01	FL-13-1	193.5	29.0	67.5	97.0	69	162	196	17	16	44

PULSE WRENCH

Non Shut-off type (bit shank)

Fig N°	Model	a	b	c	d	e	h	i	j	k	o
02	FL-4D-1(10)	140	24	35.5	80.5	44	144	169	20	18	39
02	FL-5D-1(10)	140	24	35.5	80.5	44	144	169	20	18	39
02	FL-6D-1(10)	152	24	40.5	87.5	44	144	169	20	18	39

ASSEMBLY TOOLS

Fig 01

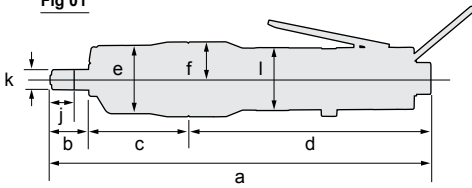

Fig 02

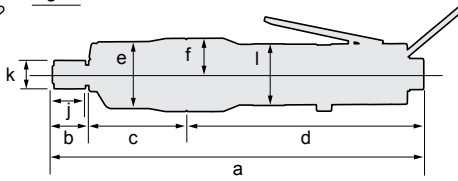
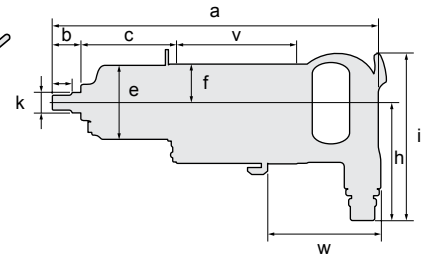

Fig 03



PULSE WRENCH

Non Shut-off type

Fig N°	Model	a	b	c	d	e	f	j	k	l
01	FLT-4S-1	221,5	23,5	54	144	41	22	12	12	40
01	FLT-5S-1	221,5	23,5	54	144	41	22	12	12	40
01	FLT-6S-1	233,5	23,5	59	151	41	22	12	12	40
02	FLT-4SD-1(10)	221,5	23,5	54	144	41	22	21,5	18	40
02	FLT-5SD-1(10)	221,5	23,5	54	144	41	22	21,5	18	40
02	FLT-6SD-1(10)	233,5	23,5	59	151	41	22	21,5	18	40

PULSE WRENCH

Straight Shut-off type (straight)

Fig N°	Model	a	b	c	v	w	e	f	h	i	j	k
03	FLT-20S-1	401	37	117	150	140	90	47.5	144	205	22	25

Fig 01

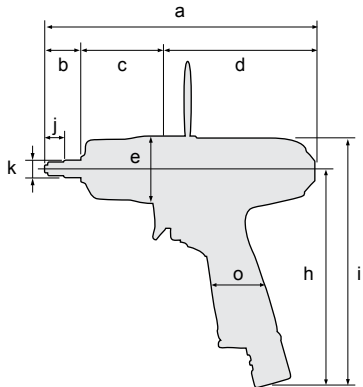
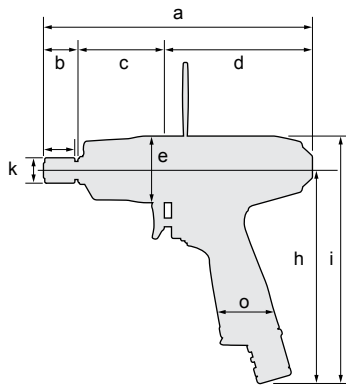

Fig 02



PULSE WRENCH

Shut-off type (square)

Fig N°	Model	a	b	c	d	e	f	h	i	j	k
01	FLT-4-2	180.5	23.5	54	103	44	142	169	11	12	40
01	FLT-5-2	180.5	23.5	54	103	44	142	169	11	12	40
01	FLT-6-2	192.5	23.5	59	110	44	142	169	11	12	40
01	FLT-7-2	191.5	23.5	54	114	50	147	177	13	12	40
01	FLT-9-2	210.5	28.0	61	122	56	150	181	18	16	40
01	FLT-11-2	219.5	28.0	65	127	65	160	192	17	16	43
01	FLT-13-2	229.5	28.0	67	135	68	163	200	17	16	45

PULSE WRENCH

Shut-off type (bit shank)

Fig N°	Model	a	b	c	d	e	f	h	i	j	k
02	FLT-4D-2(20)	181	24	54	103	44	142	169	20	18	40
02	FLT-5D-2(20)	181	24	54	103	44	142	169	20	18	40
02	FLT-6D-2(20)	193	24	59	110	44	142	169	20	18	40

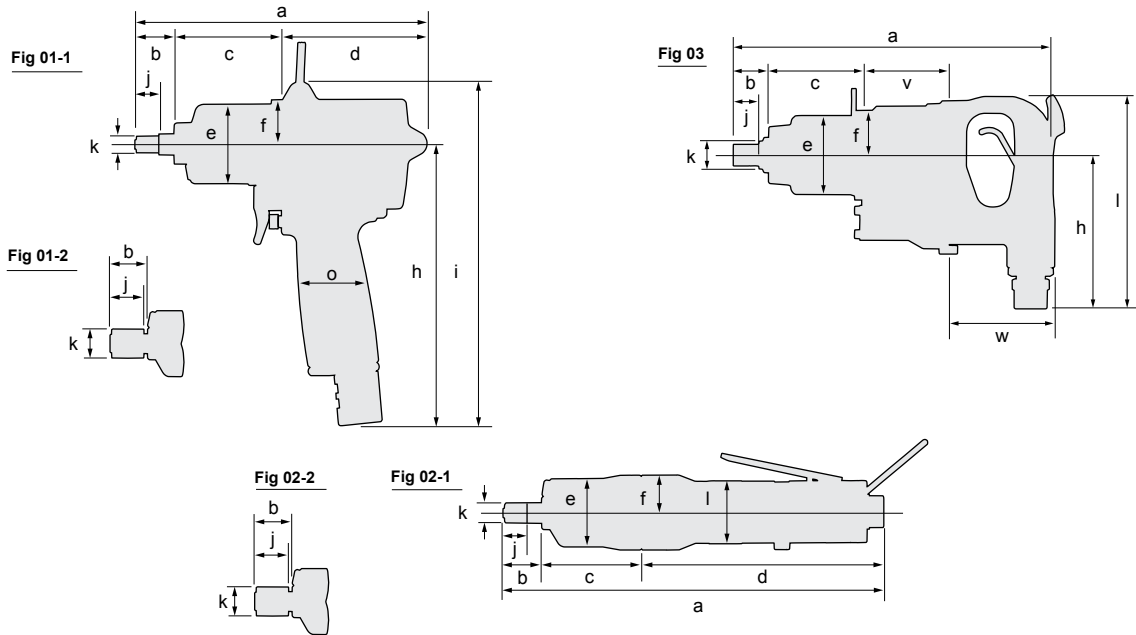

PULSE WRENCH

Pistol Grip Models

Fig N°	Model	a	b	c	d	e	f	h	i	j	k	o
01-1	FPW-110-1	143	23.5	63.5	56.0	35	20.0	144	163	12.0	12	33
01-1	FPW-1660-1	243	36.0	88.5	118.5	70	39.0	205	256	24.0	25.0	48
01-2	FPW-110D-1(10)	149	29.5	63.5	56.0	35	20.0	144	163	21.0	18	33

PULSE WRENCHES SHUT-OFF TYPE

Pistol Grip Models (High Air Pressure Use)

Fig N°	Model	a	b	c	d	e	f	h	i	j	k	o
01-1	FPT-110-1	195	23.5	68.0	103.5	35	20	143	163	12.0	12	41
01-1	FPT-1660-1	266	35.5	88.5	142.0	70	39	205	257	24.0	25	49
01-2	FPT-110D-1(10)	198	26.5	68.0	103.5	35	20	143	163	21.0	18	41

PULSE WRENCH

Straight Models

Fig N°	Model	a	b	c	d	e	f	j	k	l
02-1	FPW-110S-1	218	23.5	63.5	131	35	20.0	12	12	30.5
02-1	FPW-770S-1	240	24.0	67.0	149	44	27.0	12	12	47.0

Straight Models (High Air Pressure Use)

Fig N°	Model	a	b	c	d	e	f	j	k	l
02-1	FPT-110S-1	237	23.5	73	140.5	35	20	12	12	30.5
02-1	FPT-770S-1	275	22.5	80	172.5	45	54	12	12	45.0
02-2	FPT-110SD-1(10)	240	26.5	73	140.5	35	20	21	18	30.5

Fig N°	Model	a	b	c	d	e	f	j	k	l
02-2	FPW-110SD-1(10)	224	29	63	132	35	20.0	21	18	30.5

Fig N°	Model	a	b	c	v	w	e	f	h	i	j	k
03	FPW-2220S-1	352.5	36	103	112	101.5	90	47.5	144	204	24	25

ASSEMBLY TOOLS

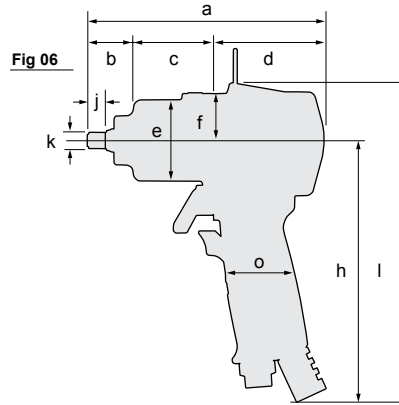
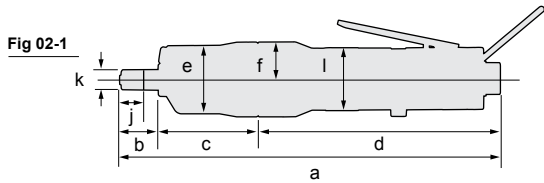

DUAL CHAMBER MOTOR IMPACT WRENCHES

Pistol Grip Models

Fig N°	Model	a	b	c	d	e	f	h	i	j	k	o
06	FW-44PA-2	131.0	23.0	38.0	70.0	39.5	22.5	144.0	166.0	12.0	12	38
06	FW-66PA-2	137.0	18.0	49.0	70.0	42.0	22.5	144.0	166.0	12.0	12	38
06	FW-88P-1	163.0	22.5	54.0	86.5	50.0	29.0	173.0	211.0	16.5	16	41

Straight Models

Fig N°	Model	a	b	c	d	e	f	j	k	l
02-1	FW-44SA-1	197.5	14.5	38	145	39.5	22.5	12	12	38
02-1	FW-66SA-1	212.0	18.0	49	145	42.0	22.5	12	12	38

IMPACT WRENCHES

Small Pistol Grip Models

Fig N°	Model	a	b	c	d	e	f	h	i	j	k	o
06	FW-5PX-6	150.0	14.0	49.0	87.0	34.0	18.0	137.0	155.0	12.0	12.0	36.0
06	FW-6PM-1	140.0	18.0	48.0	74.0	42.0	23.5	145.0	168.0	12.0	12.0	38.0
06	FW-6PL-1	175.0	18.0	52.5	104.5	42.0	27.0	122.0	152.0	12.0	12.0	35.0
06	FW-6PX-5(6)	166.0	15.0	57.0	94.0	44.0	24.0	146.0	172.0	12.0	14.0	40.0
06	FW-6PH-1(11)	147.0	16.5	62.0	68.5	50.0	29.0	162.0	198.0	12.0	14.0	43.0
06	FW-8PH-3	162.0	21.0	65.0	76.0	54.0	29.0	168.0	208.0	16.5	16.0	45.5
06	FW-10PX-5	181.8	20.8	78.0	83.0	55.5	29.0	188.0	229.0	17.0	17.0	44.0
06	FW-10PH-1	179.4	23.9	77.5	78.0	58.0	33.0	171.0	214.0	17.0	17.0	44.3
06	FW-10PH-2	179.0	24.0	77.0	78.0	58.0	31.0	171.0	213.0	16.5	17.0	44.3
06	FW-14PX-5	197.3	21.3	93.0	83.0	66.0	34.5	192.0	237.0	16.5	16.8	50.0
06	FW-14PH-1	202.0	23.0	94.5	84.5	67.0	37.5	181.5	229.5	16.5	16.8	47.6
06	FW-14PH-2	202.0	23.0	94.0	85.0	67.0	37.5	181.0	228.0	16.5	20.0	47.6
06	FW-14PH-3	202.0	23.0	94.0	85.0	67.0	37.5	181.0	228.0	18.5	20.0	47.6

Fig 02-1

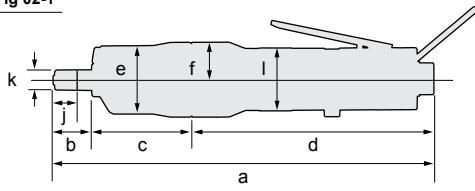

Fig 06

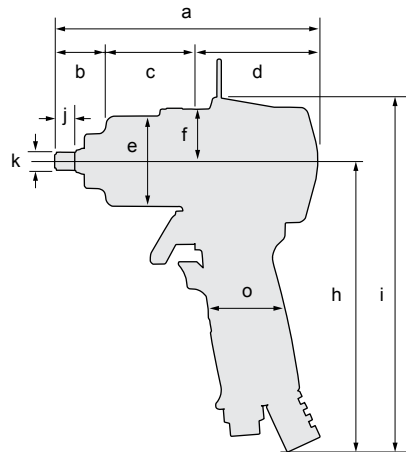

Fig 03

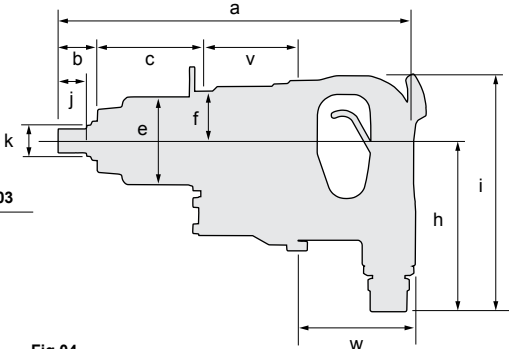

Fig 09

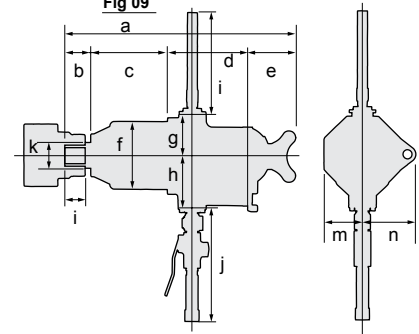

Fig 04

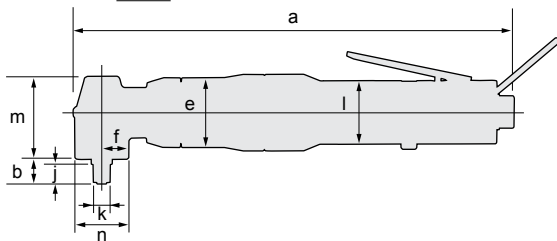
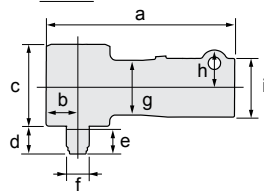

Fig 08



IMPACT WRENCHES

Straight Models

Fig N°	Model	a	b	c	d	e	f	j	k	l
02-1	FW-6SX-5	223	16	57	151	44.0	24	12.0	12	50
02-1	FW-6SX-6	225	16	57	152	44.0	24	12.0	14	50
02-1	FW-8SH-2	307	20	65	222	54.0	33	16.5	16	44
02-1	FW-10SX-5	318	21	78	219	55.5	33	17.0	17	44
02-1	FW-14SX-5	356	20	93	243	66.0	38	16.5	20	44

Angle Models

Fig N°	Model	a	b	e	f	j	k	l	m	n
04	FW-6SCX-6	262	13	44	17.5	12.0	12	49.5	46	35
04	FW-8SCH-2	354	20	58	22.0	16.5	16	44.0	63	44

CORNER ATTACHMENT (ANGLE HEAD)

Fig N°	Model	a	b	c	d	e	f	j	k	l
08	CA-14A	146	24.5	63	21	16.5	17	42	28	45

IMPACT WRENCHES

Middle Size Straight Models

Fig N°	Model	a	b	c	v	w	e	f	h	i	j	k
03	FW-19Z-5(5C)	322	29.0	109.0	72.0	112.0	72	39.0	111	175	54	25
03	FW-250-1(1C)	302	33.0	88.0	81.5	99.5	73	41.5	143	198	28	32
03	FW-250-2(2C)	302	33.0	88.0	81.5	99.5	73	41.5	143	198	24	32
03	FW-320-1(1C)	353	51.5	115.5	86.5	99.5	87	51.0	143	198	28	42
03	FW-320-1L(1CL)	484	182.0	116.0	86.5	99.5	87	51.0	143	198	28	40
03	FW-330-1(C)	356	44	126	114	56	126	196.5	31	39	79	107
03	FW-330-1L(CL)	512	200	126	114	56	126	196.5	31	39	79	107
03	FW-420-1(1C)	349	34.0	132.0	80.0	103.0	93	55.0	143	198	28	42
03	FW-420-1L(1CL)	501	186.0	132.0	80.0	103.0	93	55.0	143	198	28	42
03	FW-420-2(2C)	351	36.0	132.0	80.0	103.0	93	55.0	143	198	30	42

IMPACT WRENCHES

Middle Size Pistol Grip Models

Fig N°	Model	a	b	c	d	e	f	h	i	j	k	o
06	FW-190P-1	240	41	114	85	78.5	43.5	177.5	221	26	25	54
06	FW-250P-1	228.0	33.0	88.0	107.0	73.0	41.5	205.5	265.0	28.0	32	46
06	FW-250P-2	228.0	33.0	88.0	107.0	73.0	41.5	205.5	265.0	24.0	32	46
06	FW-320P-1	268.0	51.5	115.5	101.0	87.0	51.0	210.0	261.0	28.0	40	46
06	FW-330-P	283	44	126	113	114	63	223	286	31	39	54

Heavy Duty Straight Models

Fig N°	Model	a	b	c	d	e	f	g	h	i	j	k	l	m	n
09	FW-50-7	500	50	220	110	120	142	100	120	298	340	49.8	40	90	100
09	FW-75-7	608	68	264	134	142	175	120	150	298	340	84.0	58	164	107
09	FW-100-1	710	77	253	232	148	212	130	160	316	358	80.0	58	118	165

ASSEMBLY TOOLS

Fig 02-2

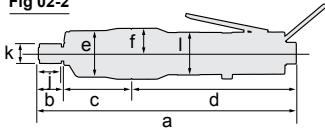

IMPACT WRENCHES

Impact clutch type

Straight Models

Fig N°	Model	a	b	c	d	e	f	j	k	l
02-2	FW-5SXD-7(70)	223	24	50	149	34	18	21	18	33.0
02-2	FW-5SXD-8(80)	194	27	50	117	34	18	21	18	33.0
02-2	FW-6SXD-6(60)	235	27	57	151	44	24	21	18	49.5

Pistol Grip Models

Fig N°	Model	a	b	c	d	e	f	h	i	j	k	o
06-2	FW-5PXD-6(60)	160	24.0	49.5	86.5	34	18.0	137	155	21	18	36
06-2	FW-6PMD-1(10)	146	24.0	48.0	74.0	42	23.5	145	168	21	18	38
06-2	FW-6PLD-1	180	23.5	52.5	104.0	42	30.0	122	152	20	19	35
06-2	FW-6PXD-6(60)	177	27.0	57.0	93.0	44	24.0	146	181	21	18	40
06-2	FW-6PHD-1	154	24.0	62.0	68.0	50	29.0	162	198	21	19	43

Fig N°	Model	a	b	c	d	e	f	j	k	l
02-2	FW-44SAD-1(10)	207	24	38	145	39.5	22.5	21	18	38
02-2	FW-66SAD-1(10)	218	24	49	145	42.0	22.5	21	18	38

Fig N°	Model	a	b	c	d	e	f	h	i	j	k	o
06-2	FW-44PAD-2(20)	132.0	24	38.0	70	39.5	22.5	144	166	21	18	38
06-2	FW-66PAD-2(20)	143.0	24	49.0	70	42.0	22.5	144	166	21	18	38

Fig 06-2

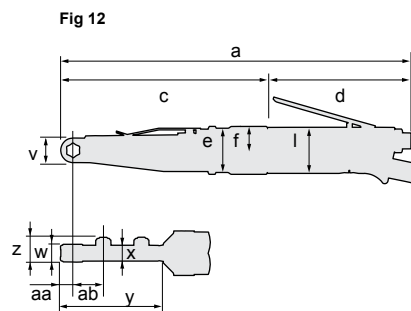
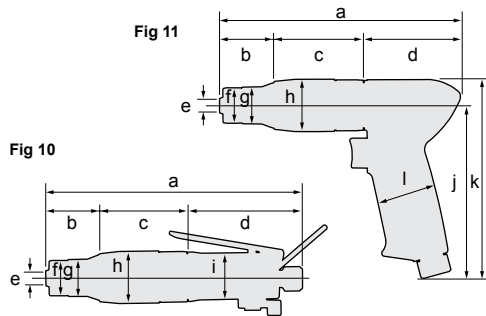
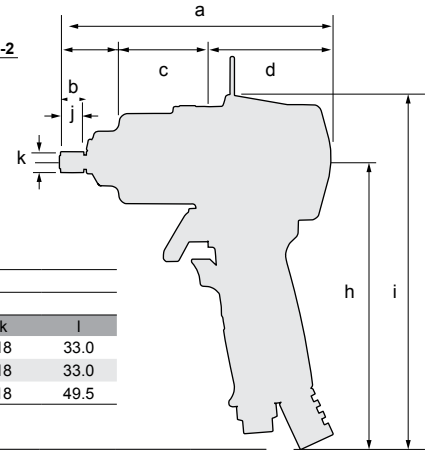

Slip clutch type

Straight Models

Fig N°	Model	a	b	c	d	e	f	g	h	i
10	FD-4	174	38.5	64	71.5	7.4	25	26	37	32
10	FD-5	233	45.0	92	96.0	7.4	25	32	42	38

Pistol Grip Models

Fig N°	Model	a	b	c	d	e	f	g	h	j	k	l
11	FD-4P	173	39	64	70	7.4	25	26	37	125	143	42
11	FD-5P	210	45	92	73	7.4	25	32	42	130	150	42

RATCHET WRENCHES

Fig N°	Model	a	c	d	e	f	l	v	w	x	y	z	aa	ab
12	FRW-6NX-3(3A)	316.0	182.0	134	38.6	21.5	32	20	13(10)	13(10)	88.0	20.2(15.2)	10.0	28.0
12	FRW-6NX-4(4A)	320.0	186.0	134	38.6	21.5	32	24	13(10)	13(10)	92.7	20.2(15.2)	12.0	30.7
12	FRW-8NX-2(2A)	380.0	217.0	163	46.0	25.0	48	25	18(10)	16(10)	108.0	25.5(15.2)	12.5	32.0
12	FRW-10N-2	417.0	228.0	189	46.0	29.0	32	33	18	16	115.0	25.5	16.5	37.5
12	FRW-13N-3	418.5	229.5	189	46.0	29.0	32	36	18	16	116.0	25.5	18.0	37.5
12	FRW-13N-4	431.0	242.0	189	46.0	29.0	32	46	18	16	129.0	25.5	23.0	45.0

Fig 14

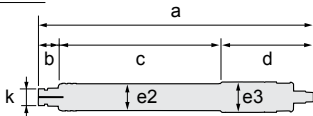

Fig 15

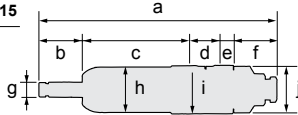

Fig 15 bis

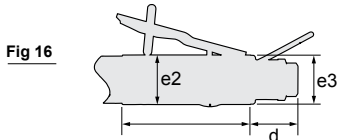
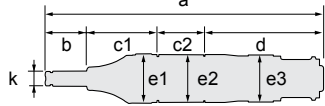

Fig 16 bis

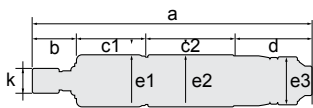

Fig 20

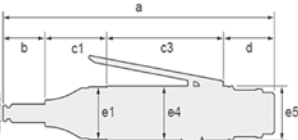

Fig 17

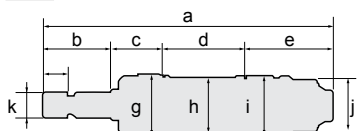

Fig 18

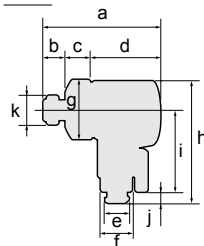

Fig 22

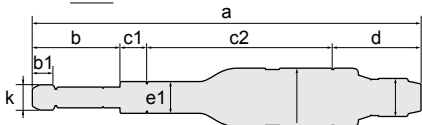
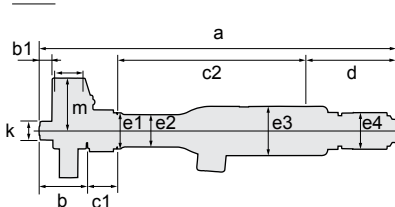

Fig 23



PENCIL GRINDERS

Fig N°	Model	a	b	c	d	e2	e3	k
14	FG-06-1	153	11	90	52	14.5	16	9.5
14	FG-06S-1	166	6	107	53	15	17	8,3

TURBO GRINDERS

Fig N°	Model	a	b	c	d	e	f	g	h	i	j
15	TURBO-100	153	28	70	18	9.0	28	9.5	29	31	29
15	TURBO-100A	155	30	70	18	9.0	28	16.0	29	31	29

Fig N°	Model	a	b	c1	c2	d	e1	e2	e3	k
15 bis	FG-13-2	149.5	27.0	42.0	35.0	45.5	30.5	29	33	9.5
15 bis	FG-13-20	149.5	44.0	25.5	35.0	45.5	30.5	29	33	9.5
15 bis	FG-13X-2	179.0	27.0	42.0	35.5	74.5	30.5	29	30	9.5
15 bis	FG-13X-20	179.0	44.0	25.5	35.5	74.5	30.5	29	30	9.5
15 bis	FG-26H-2	152	38	23.5	43.5	47	35	35.5	35	16
15 bis	FG-50H-2	165.5	38.5	25	54	48	39	38.5	39	16
15 bis	FG-26HX-2	193	40	23.5	43	86.5	35	35	35	16
15 bis	FG-50HX-2	203.5	38	25.5	54	86	39	38.5	40	16

DIE GRINDERS

Fig N°	Model	a	b	c1	c2	e1	e2	e3	d	k
16	FG-12U-1(F)	188.0	28.5	48.0	101.5	10.0	36.0	35	34.0	17.0
16	FG-13-1(F)	158.0	27.0	42.0	76.0	13.0	30.5	32	32.0	9.5
16	FG-13-10(F)	158.0	43.5	25.5	76.0	13.0	30.5	32	32.0	9.5
16	FG-25D-1(F)	198.0	28.0	52.0	108.0	10.0	38.5	39	38.0	17.0
16	FG-50D-1(F)	210.0	28.0	51.0	121.0	10.0	40.5	41	40.0	17.0
16	FG-12UX-1(F)	213.0	28.0	40.0	111.0	34.0	35.5	36	34.0	17.0
16	FG-13X-1(F)	183.0	27.0	42.0	83.5	30.5	30.5	32	32.0	9.5
16	FG-13X-10(F)	183.0	43.5	25.5	83.5	30.5	30.5	32	32.0	9.5
16	FG-25DX-1(F)	231.0	28.0	50.0	119.0	34.0	38.5	39	34.0	17.0
16	FG-50DX-1(F)	243.0	26.0	52.5	129.0	35.5	40.5	41	34.0	17.0
16 bis	FG-12U-2	191	28.5	47.5	79.5	35.5	36.0	35	33.0	17
16 bis	FG-25D-2	202	28.0	54.5	84.0	35.5	38.5	39	33.0	30
16 bis	FG-50D-2	213	28.0	51.0	98.5	35.5	40.5	41	37.0	17
16 bis	FG-12UX-2	211	29.0	40.0	54.0	88.0	36.0	36	30.5	17
16 bis	FG-25DX-2	227	28.0	50.0	61.0	88.0	38.5	36	30.5	17
16 bis	FG-50DX-2	237	26.5	52.5	72.0	86.0	40.5	42	30.5	17

DIE GRINDERS

Fig N°	Model	a	b	c1	c3	d	e1	e4	e5	k
20	FG-26H-1	161	38	23.5	93	6.5	35	36	35	16
20	FG-50H-1	176.5	38.5	25	106.5	6.5	39	41	38	16
20	FG-26HX-1	188	40	23.5	90.5	34	35	36	35	16
20	FG-50HX-1	200	38	25.5	103	33.5	39	41	37	16

DIE GRINDERS

Fig N°	Model	a	b	c	d	e	f	g	h	i	j	k
17	FG-50-25	187	44	34.5	53.5	57	16	39.5	36	38	33	16
17	FG-26H-2N	162	35	26.5	43.5	57	16	35	35.5	35	33	16
17	FG-50H-2N	174.5	38.5	25	54	57	16	39	38.5	39	33	16

DIE GRINDERS

Fig N°	Model	a	b	c	d	e	f	g	h	i	j	k
18	FG-25T	76	14	17.5	44.5	14	21	39	80	54	7.5	17Hex

Extension Type Models

Fig N°	Model	a	b1	b	c1	c2	d	e1	e2	e3	k
22	FG-3HA-1	316	18	70.5	23	150.8	71.7	27	48	32	17Hex

Extension Type Models

Fig N°	Model	a	b1	b	c1	c2	d	e1	e2	e3	k
22	FG-3HA-2	316	18	70.5	23	150.8	71.7	27	48	32	17Hex

Fig N°	Model	a	b1	b	c1	c2	d	e1	e2	e3	e4	k	l	m
23	FG-3H-6	329	14	56	24	148	101	32	27	48	32.0	17Hex	29.3	41.0
23	FG-4VA-1	385	14	53	31	203	98	38	34	52	38.5	17Hex	30.0	45.5
23	FG-4VA-2	391	17	59	31	203	98	38	34	52	38.5	21Hex	31.0	58.5

ABRASIVE TOOLS

Fig 20

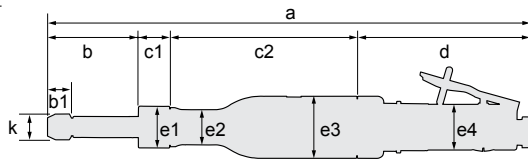
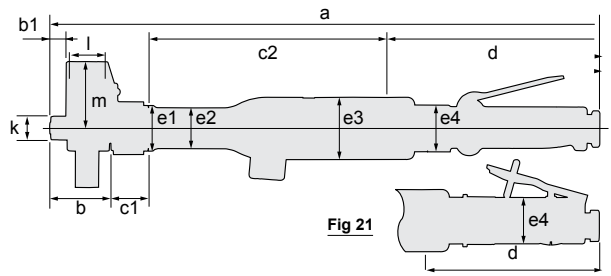

Fig 21-2



LOW SPEED GRINDERS

Locking Lever Handle Models

Fig N°	Model	a	b1	b	c1	c2	d	e1	e2	e3	e4	k
20	FG-2VX-1F	216.0	18	47.0	57.0	83	29.0	16	39	44.0	44	17Hex
20	FG-3VX-1F	331.0	18	70.5	26.5	97	137.0	16	40	41.0	34	17Hex
20	FG-3VX-6F	331.0	18	70.5	26.5	97	137.0	16	40	41.0	34	17Hex
21	FG-3VX-2F	316.0	14	55.5	26.5	97	137.0	-	40	41.0	34	17Hex
21	FG-3VX-3F	316.0	14	55.5	26.5	97	137.0	-	40	41.0	34	17Hex

STRAIGHT GRINDERS

Locking Lever Handle Models

Fig N°	Model	a	b1	b	c1	c2	d	e1	e2	e3	e4	k	l	m
21	FG-3H-1(F)	342.0	14	44.0	24	148	126.0	32	27	48.0	38.0	17Hex	18.0	41.0
21	FG-3H-2(F)	342.0	14	44.0	24	148	126.0	32	27	48.0	38.0	17Hex	18.0	46.0
21	FG-4H-1(F)	411.0	14	52.0	31	202	126.0	38	34	52.0	38.0	17Hex	31.0	58.5
21	FG-4H-2(F)	419.0	14	60.0	31	202	126.0	38	34	52.0	38.0	21Hex	31.0	58.5
21-2	FG-5H-1(M)	506.0	14	58.0	31	210	207.0	38	34	58.0	38.0	21Hex	27.0	72.0
21-2	FG-5H-2(M)	511.0	23	63.0	31	210	207.0	38	34	58.0	38.0	26Hex	27.0	72.0
21-2	FG-6H-1(M)	531.0	23	76.0	31	210	214.0	38	36	64.0	38.0	26Hex	34.0	84.7
21-2	FG-8H-1(M)	557.0	23	78.0	30	232	217.0	52	40	80.0	38.0	26Hex	38.0	111.2
21-2	FG-8H-2(M)	557.0	23	78.0	30	232	217.0	52	40	80.0	38.0	26Hex	34.8	99.7

Fig 21-3

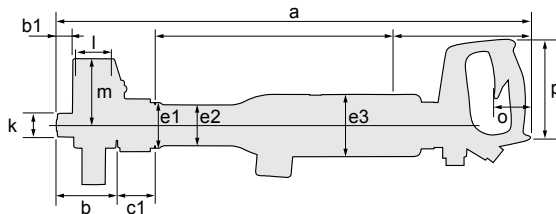

STRAIGHT GRINDERS

Grip Handle Models

Fig N°	Model	b1	b	c1	c2	d	e1	e2	e3	k	l	m	o	p
21-3	FG-8H-1C	23	78.0	30	232	198.0	52	40	80.0	26Hex	38.0	111.2	57	124

Fig 20

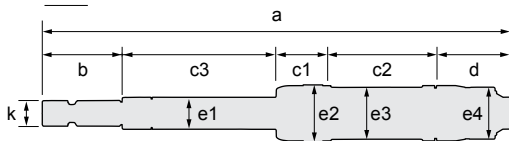
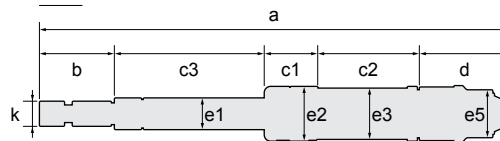

Fig 21



Extension Type Models

Fig N°	Model	a	b	c	d	e	f	g	h	i	j	k
20	FG-26L-1	297	51	98	31	70	47	20	36	33	33	16
20	FG-26HL-2	263	55	94	23.5	43.5	47	16	35	35.5	33	16

Fig N°	Model	a	b	c	d	e	f	g	h	i	j	k
21	FG-26L-1N	304	51	98	31	70	54	20	36	33	38	16
21	FG-26HL-2N	273	55	94	23.5	43.5	57	16	35	35.5	33	16

Fig 17

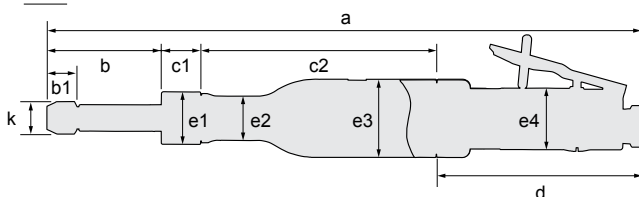
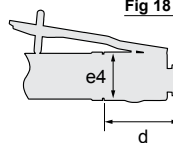

Fig 18



Extension Type Models

Fig N°	Model	a	b1	b	c1	c2	d	e1	e2	e3	e4	k
17	FG-3H-5F	369	18	71	24	148	126	32	27	48	38	17Hex

Fig N°	Model	a	b	c3	c1	c2	d	e1	e2	e3	e4	k
18	FG-26L-1BF	307	51	98	31	71	56	20	36	33	35	16

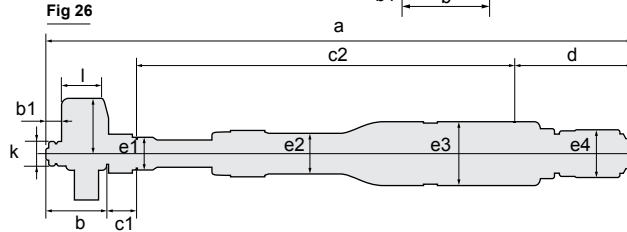
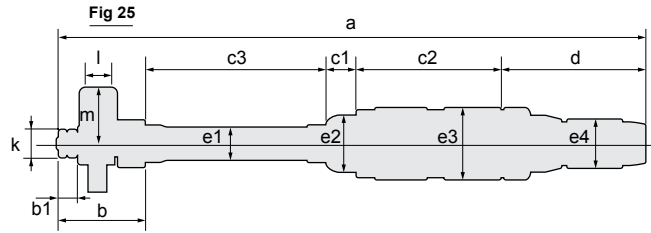
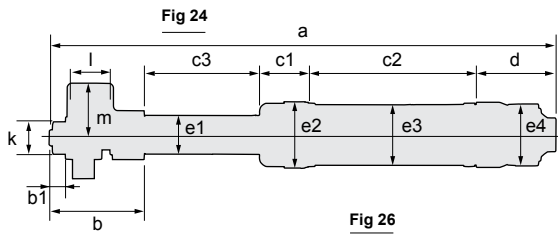

Extension Type Models

Fig N°	Model	a	b1	b	c3	c1	c2	d	e1	e2	e3	e4	k	l	m
24	FG-50L-1(A)	307.5	8	36.0	91	29	103.5	48	23	39.5	36	37	17Hex	22	32
24	FG-50Y-1(A)	523.0	8	36.5	306	29	103.5	48	23	39.5	36	37	17Hex	22	32

Fig N°	Model	a	b1	b	c3	c1	c2	d	e1	e2	e3	e4	k	l	m
25	FG-3HL-1(A)	522	14	43	252	21	105	101	23	40	48	32	17Hex	22.5	40.5
25	FG-3HY-1(A)	702	14	43	405	21	104	102	23	40	48	32	17Hex	22.5	40.5

Fig N°	Model	a	b1	b	c1	c2	d	e1	e2	e3	e4	k	l	m
26	FG-4HL-1(A)	585.0	14.0	50	22	415.0	98	27	34	52	38.5	17Hex	30	45.5
26	FG-5HL-1(A)	957.5	17.0	63	24	764.5	106	46	34	58	38.5	17Hex	30	43.5
26	FG-5HL-2(A)	953.0	14.0	63	24	760.0	106	36	34	58	38.5	17Hex	31	58.5
26	FG-5HL-11(A)	599.0	16.0	50	22	418.5	108	27	34	58	38.0	19Hex	30	45.5
26	FG-5HL-13(A)	599.0	16.5	50	23	418.5	108	27	34	58	38.0	19Hex	31	56.5
26	FG-5HL-14	599.0	16.5	50	23	418.5	108	27	34	58	38	19Hex	31	56.5

Fig 21-2

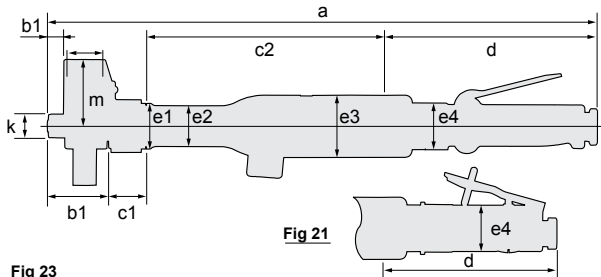

Fig 23

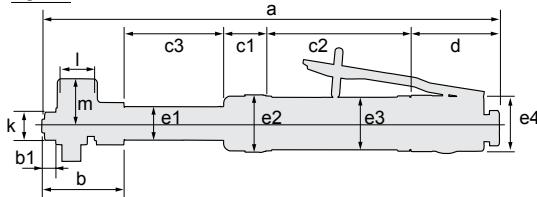
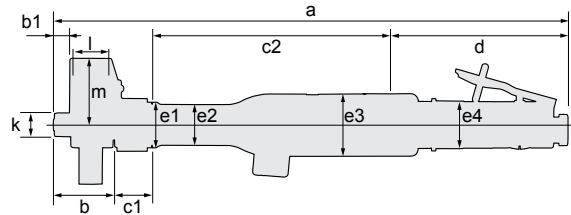

Fig 21-4



EXTENDED GRINDERS

Locking Lever Handle Models

Fig N°	Model	a	b1	b	c3	c1	c2	d	e1	e2	e3	e4	k	l	m
23	FG-50L-1BF	316.5	8	36.0	91	29	103.5	57	23	39.5	36	39	17Hex	22.0	32.0
23	FG-50Y-1BF	532.0	8	36.5	306	29	103.5	57	23	39.5	36	39	17Hex	22.0	32.0
23	FG-3HL-1F	547.0	14	43.0	252	21	105.0	126	23	40.0	48	38	17Hex	22.5	40.5

Fig N°	Model	a	b1	b	c3	c1	c2	d	e1	e2	e3	e4	k	l
21-4	FG-4HL-1F	613.0	14	50.0	22	415	126.0	27	34	52.0	38	17Hex	33	45.5
21-2	FG-5HL-2M	1055.0	14	63.0	24	760	208.0	36	34	58.0	38	21Hex	31	58.5

ABRASIVE TOOLS

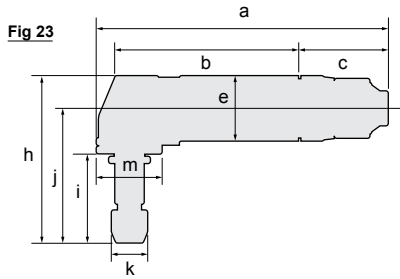

ANGLE GRINDERS

Roll Throttle Models

Fig N°	Model	a	b	c	e	h	i	j	k	m
23	FA-2C-30	156.5	98.5	48	35	80	37	62	16	35.5
23	FA-2CX-30	197.5	98.5	89	35	80	37	62	16	35.5

AngleType Models

Side Exhaust Type

Fig N°	Model	a	b	c	d	e	f	h	i	j	l	m
19	FA-2C-2BF	190	110	80	42.5	35	35	5	90.3	18	17Hex	
19	FA-2C-30F	190	108.5	81.5	43	35	35	5	80	16	17Hex	35.5
19	FA-2CX-30F	226	108.5	117.5	43	35	35	5	80	16	16	35.5

Rear Exhaust Type

Fig N°	Model	a	b	c	d	e	f	h	i	j	l
19	FA-2CX-2BF	226	109	117	42.5	35	35.0	5	90.3	18	17Hex
19	FA-2CX-3BF	226	109	117	42.5	35	35.0	5	90.3	18	17Hex

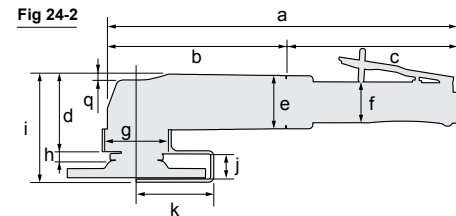
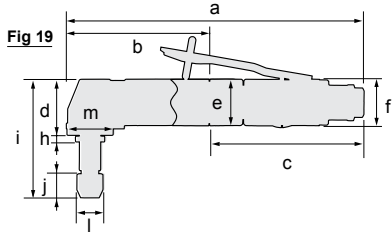

ANGLE GRINDERS

Locking Lever Handle Models

Fig N°	Model	a	b	c	d	e	f	g	h	i	j	k	q
24-2	FA-30	180.5	118.5	62	53.6	38	38	55	7	78.5	23.3	57.6	5.3
24-2	FA-30X-2	208.5	118.5	90	53.6	38	36	55	7	78.5	23.3	57.6	5.3
24-2	FA-40	208	123	85	64.5	50	37	57.5	9	91	24.8	59.1	15
24-2	FA-30-2F	191.5	118.5	73	53.6	38	35	55	7	78.5	23.3	57.6	5.3
24-2	FA-30X-2F	219	118.5	100.5	53.6	38	35	55	7	78.5	23.3	57.6	5.3
24-2	FA-40-1F	247	123	124	64.5	50	38	57.5	9	91	24.8	59.1	15
24-2	FA-2C-1BF	190.0	111.0	79.0	42.5	35	35	35	5	59.5	18.8	33.6	
24-2	FA-3C-1F	192.5	116.5	76.0	56.0	38	35	45	7	76.2	17.0	46.1	
24-2	FA-3C-2F	192.5	116.5	76.0	56.0	38	35	45	7	78.2	19.0	57.6	
24-2	FA-2CX-1BF	226.0	109.0	117.0	42.5	35	35	35	5	59.5	18.8	33.6	
24-2	FA-3CX-1F	247.0	133.0	114.0	56.0	40	35	45	8	76.2	17.0	46.1	
24-2	FA-3CX-2F	247.0	133.0	114.0	56.0	40	35	45	7	78.2	19.0	57.6	
24-2	FA-5E-13F	279.5	110.5	169.0	61.5	52	40	45	13	90.7	18.5	72.6	4.5
24-2	FA-5E-13VF	260.5	110.5	150.0	61.5	52	40	45	13	90.7	18.5	72.6	4.5
24-2	FA-6C-8M	353.0	146.0	207.0	74.0	56	38	60	32.0	126.0	25.8	98.0	-
24-2	FA-7E-6VF	307.0	145.5	161.5	75.6	62	40	60	26.2	120.5	21.0	100.5	6

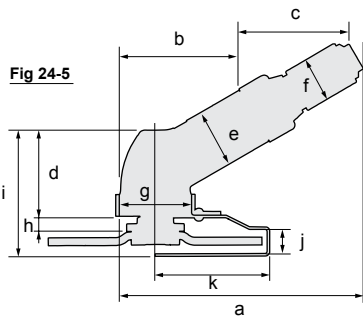

ANGLE GRINDERS

Roll Throttle Models

Fig N°	Model	a	b	c	d	e	f	g	h	i	j	k
24-5	FA-3CK-2	164	95	70	63	40	33	45	14.5	95	23.8	57.6
24-5	FA-150KG-5	206	127	79	72	50	36	60	15.0	107	20.8	96.6

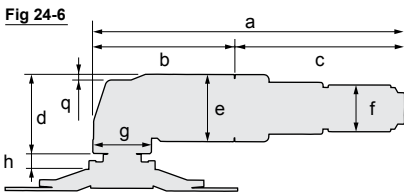

ANGLE GRINDERS

Roll Throttle Models

Fig N°	Model	a	b	c	d	e	f	g	h	q
24-6	FA-5E-7V	210.5	110.5	100	61.5	52	36	45	13.0	4.5

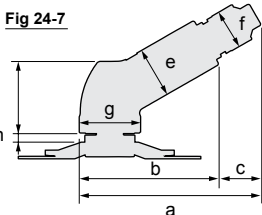

ANGLE GRINDERS

Roll Throttle Models

Fig N°	Model	a	b	c	d	e	f	g	h
24-7	FA-150KG-7	206	127	79	72.0	50	36.0	60	15.0
24-7	FA-150K-20	179	137	42	71.6	60	39.5	60	9.0

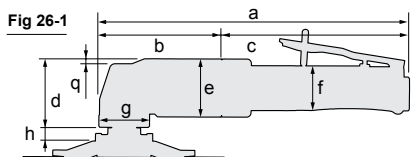

ANGLE GRINDERS

Locking Lever Handle Models

Fig N°	Model	a	b	c	d	e	f	g	h	q
26-1	FA-5E-6VF	260.5	110.5	150.0	61.5	52.0	40.0	45	13.0	4.5
26-1	FA-7E-5VF	307.0	145.5	161.5	75.6	62.0	40.0	60	26.2	6.0

Fig 24

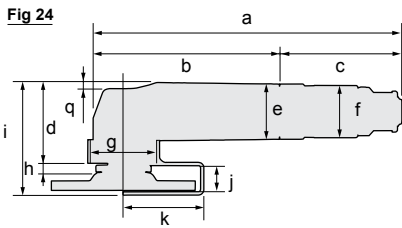

ANGLE GRINDERS

Roll Throttle Models

Fig N°	Model	a	b	c	d	e	f	g	h	i	j	k
24	FA-4C-1	212	111	101	69.0	48	32	52	8	95	14.8	57.6
24	FA-4C-3	212	110	103	69.0	48	37	52	8	95	14.8	57.6
24	FA-6C-1	252	146	106	74.0	56	38	60	15	108	20.8	96.6
24	FA-6C-7	252	146	106	74.0	56	38	60	18	108	17.8	84.1
24	FA-7C-1	263	143	120	74.0	63	42	60	15	109	17.8	96.6
24	FA-9C-1	305	166	139	80.0	69	42	60	15	114	20.0	110.0
24	FA-9C-6	305	166	139	80.0	69	42	60	17	117	21.0	122.0

Fig N°	Model	a	b	c	d	e	f	g	h	i	j	k	q
24	FA-5E-1V	210.5	110.5	100.0	61.5	52	36	45	13.0	90.7	18.5	72.6	4.5
24	FA-5E-3V	210.5	110.5	100.0	61.5	52	36	45	13.0	90.2	19.0	57.6	4.5
24	FA-5E-11V	210.0	109.0	101.0	63.0	52	36	45	10.5	96.0	19.0	100.5	4.5
24	FA-7E-2V	266.0	145.5	120.5	75.6	62	42	60	17.0	110.5	21.0	100.5	6.0
24	FA-30-2	180.5	118.5	62	53.6	38	38	55	7	78.5	23.3	57.6	5.3
24	FA-30X-2	208.5	118.5	90	53.6	38	36	55	7	78.5	23.3	57.6	5.3
24	FA-40-1	208	123	85	64.5	50	37	57.5	9	91	24.8	59.1	15

Fig N°	Model	a	b	c	d	e	f	g	h	i	j	k	q
24	FA-7E-4V	305	135	163	77.5	62	42	60	20	112.5	19	95.8	6

Fig 28

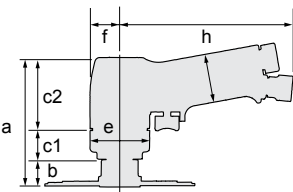

Fig 29-1

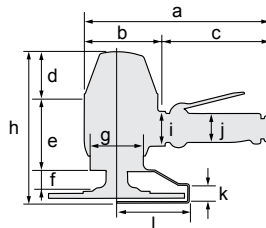

Fig 29-2



Fig 29-3



DISC SANDERS

Fig N°	Model	a	b	c1	c2	e	f	g	h
28	FG-5PX-10	108.0	21.0	24.0	63.0	50.0	25.0	41	147.0

VERTICAL GRINDERS

Standard Type

Fig N°	Model	a	b	c	d	e	f	g	h	i	j	k	l
29-1	FV-7-1M	247.0	100.0	147.0	63.0	94.4	26.2	64	201.0	46	38	22.0	96.6
29-1	FV-7-4M	247.0	100.0	147.0	63.0	94.4	26.2	64	201.0	46	38	22.0	96.6
29-1	FV-9BH-1M	266.0	127.5	138.5	69.0	119.0	50.2	69	238.2	46	38	30.0	122.0

Cup Wheel Type

Fig N°	Model	a	b	c	d	e	f	g	h	i	j	l	m
29-3	FV-9BH-4M	266.0	127.5	138.5	69.0	119.0	76	69	264.0	46	38	88.4	56-85

Sanding Disc Type

Fig N°	Model	a	b	c	d	e	f	g	i	j
29-2	FV-7-2M	247.0	100.0	147.0	63.0	94.4	38	64	46	38

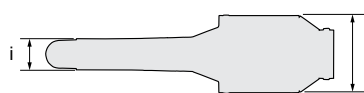
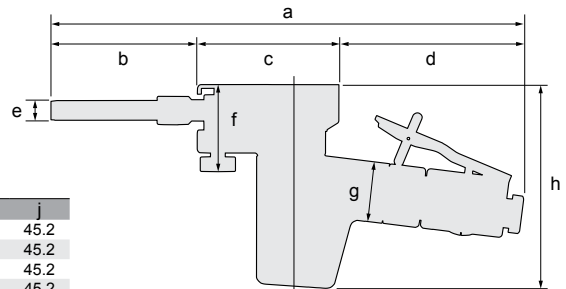

Fig 30



BELT SANDERS

Fig N°	Model	a	b	c	d	e	f	g	h	i	j
30	FBS-1-1	281	87	84	110	10	51	35	121	18	45.2
30	FBS-1-2	375	181	84	110	20	51	35	121	22	45.2
30	FBS-1-3	345	151	84	110	13	51	35	121	18	45.2
30	FBS-1-4	345	151	84	110	20	51	35	121	22	45.2

Fig 31

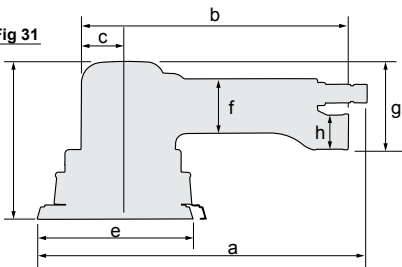
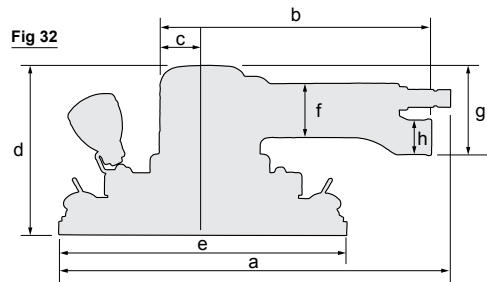

Fig 32



ORBITAL SANDERS

Locking Lever Handle Models

Fig N°	Model	a	b	c	d	e	f	g	h
31	DA-125L-E(-M)	172	142	33	97	125	-	45	26
31	DA-125C-E(-M)	172	142	33	117	125	-	45	26
31	FOR-125B-E(-M)	259	216	35	122	125	42	69	26
31	FOR-150B-E(-M)	276	124	35	122	150	42	68	26
31	FOR-125BF-E(-M)	259	216	35	122	125	42	69	26
31	FOR-150BF-E(-M)	276	124	35	122	150	42	68	26
32	FOS-175BF-E(-M)	285	216	35	130	100X175	42	69	26
32	FOS-230BF-E	312	217	35	132	100X230	42	68	26
32	FOS-400BF-E	400	211	32	138	100X400	43	66	26

DRILLS

Fig 33

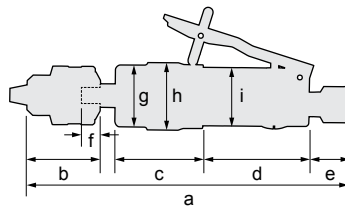
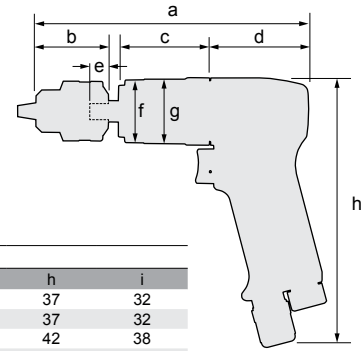

Fig 34-1



DRILLS

Straight / Side Exhaust Type

Fig N°	Model	a	b	c	d	e	f	g	h	i
33	FRD-5S-1(F)	179	40	49	58.5	22.5	12	34	37	32
33	FRD-5S-2T(F)	168	32	49	58.5	22.5	12	34	37	32
33	FRD-6S-2(F)	209	40	57	82.5	22.5	12	39	42	38
33	FRD-6S-3(F)	212	43	57	82.5	22.5	12	39	42	38
33	FRD-6S-5(F)	230	51	69	82.5	22.5	12	41	46	38
33	FRD-6S-7(F)	265	64	91	82.5	22.5	15	32	42	38

Pistol / Rear Exhaust Type

Fig N°	Model	a	b	c	d	e	f	g	h
34-1	FRD-5P-1	155	40	46.5	60.5	12	34	35	159
34-1	FRD-8PX-1	187	43	62.0	75.0	12	40	45	191
34-1	FRD-8PX-2	210	51	77.0	75.0	12	40	52	191
34-1	FRD-8PX-3	240	64	95.0	75.0	15	48	51	191
34-1	FRD-6PH-2 (TH)	202	45	56	49	14	37	42	158
34-1	FRD-6PH-3 (TH)	202	45	56	49	14	37	42	158
34-1	FRD-6PH-3 8 (TH)	204	47	56	49	14	37	42	158
34-1	FRD-6PH-5 (TH)	247	52	91	49	15	42	42	158
34-1	FRD-6PH-7 (TH)	260	65	88	49	20	42	42	158
34-1	FRD-6PH-2 W/O C	-	-	56	49	14	37	42	158
34-1	FRD-6PH-3 W/O C	-	-	56	49	14	37	42	158
34-1	FRD-6PH-5 W/O C	-	-	91	49	15	42	42	158
34-1	FRD-6PH-7 W/O C	-	-	88	49	20	42	42	158

Fig 35-1

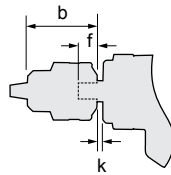
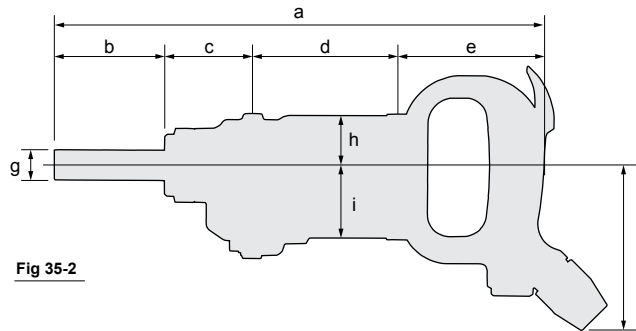

Fig 35-2



Grip Handle Middle Size Drills

Fig N°	Model	a	b	c	d	e	f	k	g	h	i	j
35-1	FRD-12Z-1(C)	349	51	58	96	97	15	5	-	33	47	108
35-1	FRD-16Z-1(C)	374	73	58	96	97	20	8	-	33	47	108

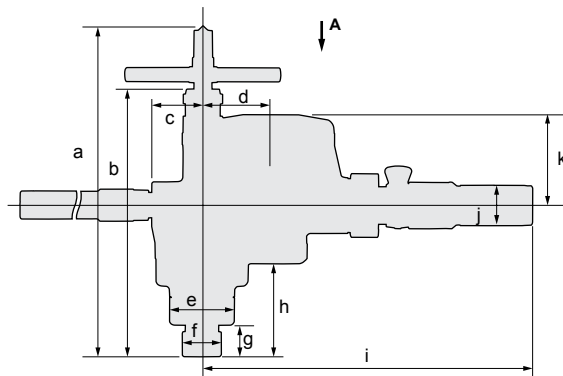
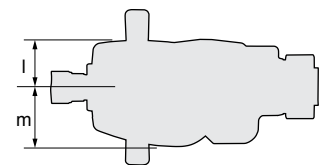

Fig 36



A VIEW

Grip Handle Middle Size Drills

Fig N°	Model	a	b	c	d	e	f	g	h	i	j	k	l	m
36	FRD-20R-21(S)	278.5~345.5	220.5	37	56.7	52	26	15.6	85.6	300.7	38	75.9	39	39
36	FRD-20R-22(S)	305~372	247.0	37	56.7	48	32	27.1	112.1	300.7	38	75.9	39	39
36	FRD-23R-21(S)	278.5~345.5	220.5	37	56.7	52	26	15.6	85.6	300.7	38	75.9	39	39
36	FRD-23R-22(S)	305~372	247.0	37	56.7	48	32	27.1	112.1	300.7	38	75.9	39	39
36	FRD-25R-11(S)	354.4~450.4	293.4	55	75.0	70	42	34.6	102.6	364.0	43	99.4	51	65
36	FRD-28R-11(S)	354.4~450.4	293.4	55	75.0	70	42	34.6	102.6	364.0	43	99.4	51	65
36	FRD-32R-11(S)	354.4~450.4	293.4	55	75.0	70	42	34.6	102.6	364.0	43	99.4	51	65
36	FRD-32R-12(S)	382.4~478.4	321.4	55	75.0	70	49	62.6	130.6	364.0	43	99.4	51	65
36	FRD-40R-11(S)	446.4~539.4	385.4	55	75.0	78	52	41.6	195.1	364.0	43	99.4	65	65
36	FRD-50R-11(S)	446.4~539.4	385.4	55	75.0	78	52	41.6	195.1	364.0	43	99.4	65	65
36	FRD-65R-1	466~591	391.0	82	121.7	87	70	46.0	141.0	572.0	48	122.0	68	68
36	FRD-75R-1	600~728	525.0	82	121.7	87	70	67.0	165.0	572.0	48	122.0	68	68
36	FRD-75R-1S	600~728	525.0	82	121.7	87	70	67.0	165.0	552.0	43	122.0	68	68
36	FRD-100R-1	600~728	525.0	82	121.7	87	70	67.0	165.0	572.0	48	122.0	68	68

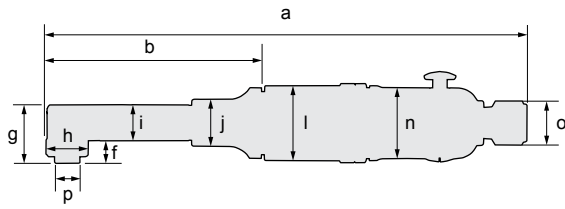

Fig 37

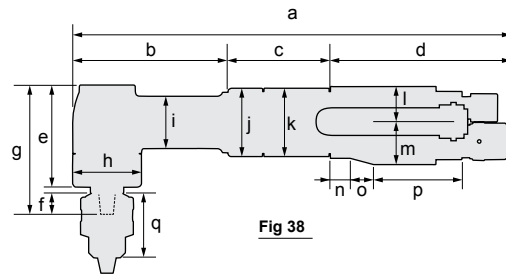

Fig 38

BABY ANGLE DRILLS

Fig N°	Model	a	b	f	g	h	i	j	l	n	o	p
37	FCD-6A-1	223	99.5	10.5	26.5	19	16	21	34	32	19.6	9.5Hex
37	FCD-6B-1(F)	222	99.5	10.5	26.5	19	16	21	34	32	19.6	9.5Hex
37	FCD-6EX-3	246	94.0	7.0	27.0	17	17	22	38	35	27.0	-
37	FCD-6EX-4	246	94.0	7.0	27.0	17	17	22	38	35	27.0	-

BABY ANGLE DRILLS

Fig N°	Model	a	b	c	d	e	f	g	h	i	j	k	l	m	n	o	p	q
38	FCD-6X-1(F)	273	97	64	112	63	12	79	42	32	42	42	22.0	26.0	12	15	54	40
38	FCD-6X-2(F)	286	97	77	112	63	12	79	42	32	42	44	22.0	26.0	12	15	54	43
38	FCD-10X-1(F)	377	93	60	224	62	14	82	42	36	46	50	24.5	17.5	82	10	84	51

Fig 39

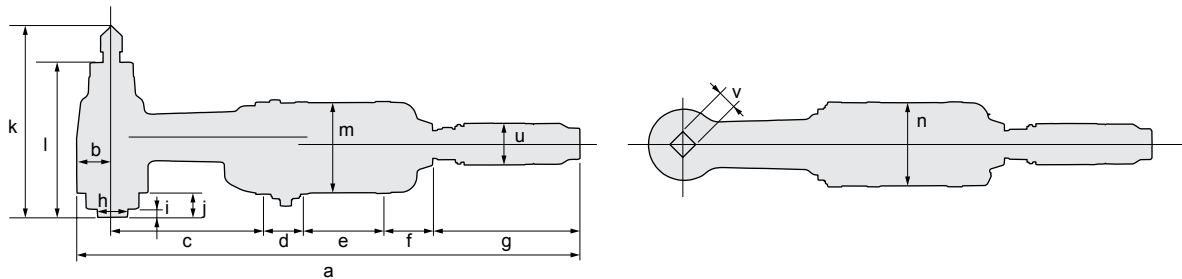

HEAVY-DUTY CORNER DRILLS

Fig N°	Model	a	b	c	d	e	f	g	h	i	j	k	l	m	n	u	v
39	F-14CN(-1S)	414	24	150	20	70	55	95	22	6.0	21.0	135.0~173.0	110.0	71.7	62	40	16
39	F-14CN(-2S)	414	24	150	20	70	55	93	29	16.5	33.5	147.5~185.5	122.5	71.7	62	40	16
39	F-22RCN(-1S)	499	35	150	39	79	50	146	29	8.0	24.0	177.0~237.0	152.0	88.0	82	38	16
39	F-32RCN(-1S)	529	40	175	39	79	50	146	34	11.0	21.0	195.0~255.0	170.0	88.0	82	38	16
39	F-32RCNS(-1S)	529	40	175	39	79	50	146	35	1.0	9.0	126.0~151.0	107.0	88.0	82	38	14
39	F-22RCR(-1S)	528	35	150	39	79	50	175	29	8.0	24.0	177.0~237.0	152.0	88.0	82	38	16
39	F-32RCR(-1S)	558	40	175	39	79	50	175	34	11.0	21.0	195.0~255.0	170.0	88.0	82	38	16
39	FCD-23R(-11S)	473	27	96	39	80	60	172	27	5.5	15.5	151.5~186.5	126.5	91.5	81	38	16
39	FCD-23R(-12S)	473	27	96	39	80	60	172	31	14.5	37.5	172.5~207.5	147.5	91.5	81	38	16
39	FCD-32R-11(S)	579	35	118	50	101	72	203	35	10.0	26.0	194.0~247.0	164.0	110.0	96	43	16
39	FCD-50R-11(S)	596	42	128	50	101	75	200	44	16.0	38.0	230.0~288.0	191.0	110.0	96	43	22.2
39	FCD-75R-11(S)	652	49	157	50	121	75	200	60	18.0	48.0	272.0~329.0	227.0	110.0	96	43	25.4
39	FCD-100R-11(S)	729	62	241	50	101	75	200	60	38.0	75.0	306.0~411.0	285.0	110.0	96	43	23

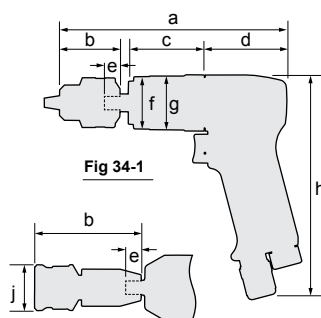

Fig 34-2

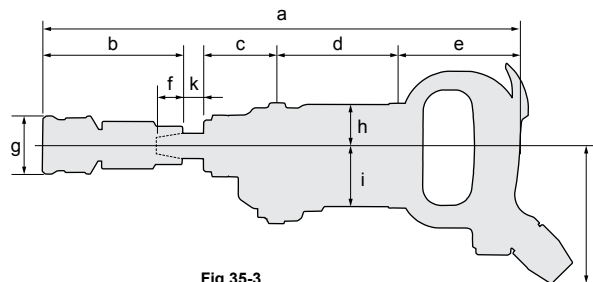

Fig 35-3

TAPPERS

Fig N°	Model	a	b	c	d	e	f	g	h	j
34-1	FT-6P-1	236	45	112	63.5	15	38	45	154.0	-
34-1	FT-6BX-1D	206	40	34	128.0	15	46	47	143.5	-
34-2	FT-6BX-1T	241	75	34	128.0	15	46	47	143.5	32
34-2	FT-8PX-1	232	78	27	121.0	14	46	45	193.0	32

Fig N°	Model	a	b	c	d	e	f	g	h	i	j	k
35-3	FT-13Z-1	427	70	92	108	97	20	45	37	65	108	18

PERCUSSIVE TOOLS

FLUX CHIPPERS

Fig N°	Model	a	b	c	d	e	f	g	h
41	FCH-20(-1F)	176	66	52	58	33	32	36	9.0
41	FCH-20F(-1F)	182	42	82	58	39	32	36	12.7
41	FCH-25(-1F)	204	44	92	68	39	40	44	12.7
41	FCH-25B(-1F)	239	44	92	103	39	40	44	12.7

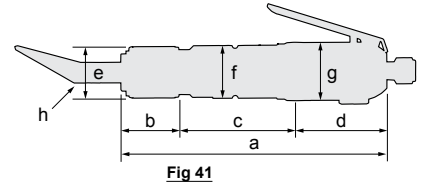

Fig 41

LIGHT HAMMERS

Fig N°	Model	a	b	c	d	e	f	g	h	b1
42	FRH-3-1	140	39.5	10	38	52.5	30	25	121	38
42	FRH-3-2	140	39.5	10	38	52.5	30	25	121	38
42	FRH-6-1	206	39.5	76	38	52.5	30	25	121	38
42	FRH-6-2	206	39.5	76	38	52.5	30	25	121	38
42	FRH-6A-1	193	42.0	63	36	52.0	36	25	121	36
42	FRH-6A-2	193	42.0	63	36	52.0	36	25	121	36

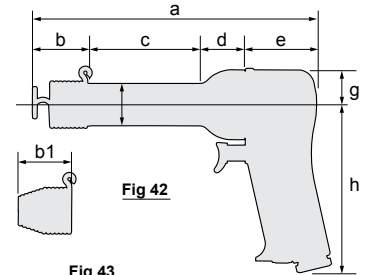

Fig 42

CHIPPING AND CALKING HAMMERS

Fig N°	Model	a	b	c	d	e	f	g	h	i	j
43	FC-01SA-H	281.0	49.0	65	37.0	119	11	23	39	53	142
43	FC-01SA-R	281.0	49.0	65	37.0	119	11	23	39	53	142
43	FC-01-3	284.0	60.0	57	37.0	119	11	30	40	44	142
43	FC-01-4	284.0	60.0	57	37.0	119	11	30	40	44	142
43	FC-1Z-1	343.5	79.5	54	39.5	147	23	46	59	63	158
43	FC-1Z-2	343.5	79.5	54	39.5	147	23	46	59	63	158
43	FC-2Z-1	384.5	79.5	95	39.5	147	23	46	59	63	158
43	FC-2Z-2	384.5	79.5	95	39.5	147	23	46	59	63	158
43	FC-3Z-1	428.5	79.5	139	39.5	147	23	46	59	63	158
43	FC-3Z-2	428.5	79.5	139	39.5	147	23	46	59	63	158
43	FC-4Z-1	467.5	79.5	178	39.5	147	23	46	59	63	158
43	FC-4Z-2	467.5	79.5	178	39.5	147	23	46	59	63	158

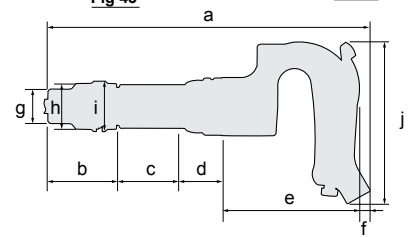

Fig 43

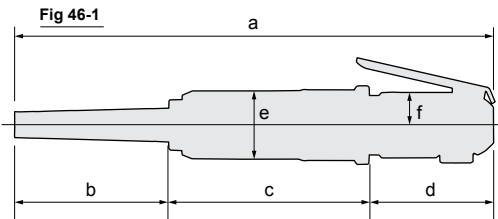

Fig 46-1

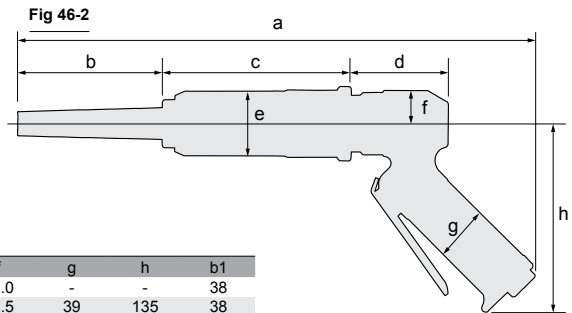

Fig 46-2

NEEDLE SCALERS

Fig N°	Model	a	b	c	d	e	f	g	h	b1
46-1	FNS-2(-1F)	325	104	136	85	46	22.0	-	-	38
46-2	FNS-2P(-1F)	372	104	136	70	46	23.5	39	135	38

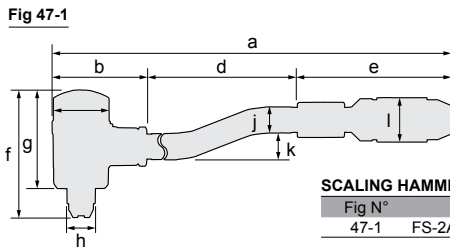

Fig 47-1

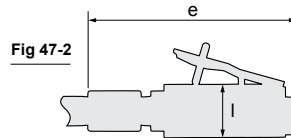

Fig 47-2

SCALING HAMMERS

Fig N°	Model	a	b	c	d	e	f	g	h	i	j	k	l
47-1	FS-2A-1(F)	535	82	-	295	158	110-94	85	21	50	22	23	40

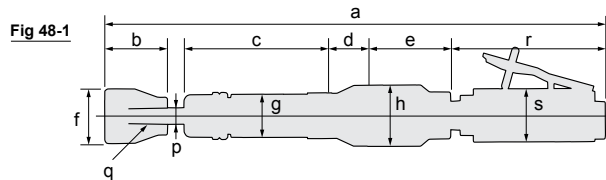

Fig 48-1

SAND RAMMERS

Fig N°	Model	a	b	c	d	e	f	g	h	s	i	j	p	q
48-1	FR-18B-2(F)	390-440	47	114	28	63	41	118	32	46	40	-	-	12.0 taper 1:20
48-1	FR-22B-2(F)	465-529	60	154	35	68	51	118	38	50	40	-	-	14.0 taper 1:20
48-1	FR-25B-2(F)	630-713	80	228	49	90	67	118	46	60	40	-	-	17.5 taper 1:20

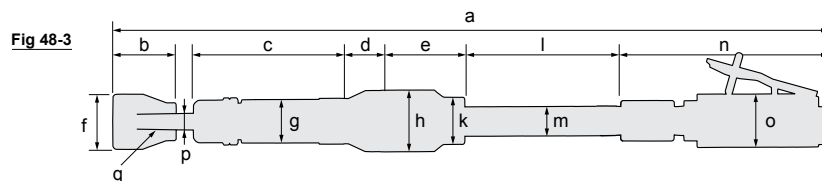
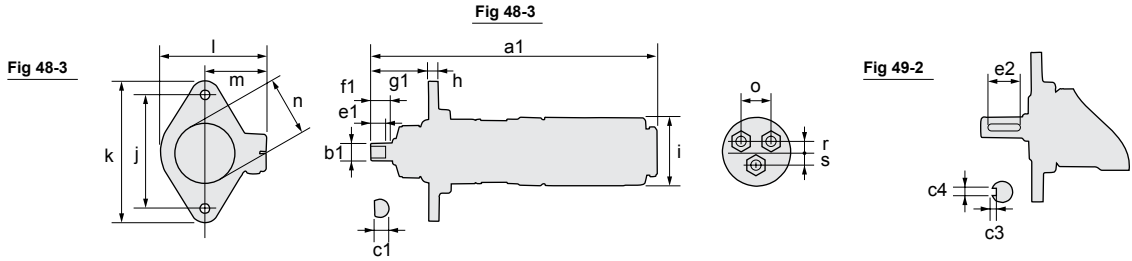

Fig 48-3

Fig N°	Model	a	b	c	d	e	f	g	h	k	l	m	n	p	q
48-4	FR-18L-2(F)	542-592	60	113	28	64.0	51	32	46	35	124	21.7	158	40	12.0 taper 1:20
48-4	FR-22L-2(F)	614-678	60	154	35	68.0	51	38	50	35	124	21.7	158	40	14.0 taper 1:20
48-4	FR-25L-2(F)	1038-1121	80	228	49	90.0	67	46	60	45	400	21.7	158	40	17.5 taper 1:20
48-4	FR-32-2(F)	1123-1250	92	260	60	85.6	75	53	68	50	401	27.5	158	40	19.0 taper 1:20



AIR MOTORS

Reversible Type

Fig N°	Model	a1	b1	c1	c3	c4	e1	e2	f1	g1	h	i	j	k	l	m	n	o	r	s
49-1	F-5SM-8.5R	147	8	7.0	-	-	10	-	12	20.0	5	40	60	74	55	33	35	18	6.5	8.0
49-1	F-5SM-2R	180	8	7.0	-	-	10	-	12	25.0	5	40	60	74	55	33	35	18	6.5	8.0
49-1	F-6SM-28R	146	10	8.5	-	-	12	-	14	19.0	6	42	70	88	64	38	39	20	6.5	8.0
49-1	F-6SM-21R	146	10	8.5	-	-	12	-	14	19.0	6	42	70	88	64	38	38	20	6.5	8.0
49-1	F-6SM-12R	157	10	8.5	-	-	12	-	14	18.0	6	42	70	88	64	38	39	20	6.5	8.0
49-1	F-6SM-8R	179	10	8.5	-	-	12	-	14	36.0	6	42	70	88	64	38	39	20	6.5	8.0
49-1	F-6SM-5R	179	10	8.5	-	-	12	-	14	36.0	6	42	70	88	64	38	38	20	6.5	8.0
49-1	F-6SM-2.5R	192	10	8.5	-	-	12	-	14	36.0	6	42	70	88	64	38	38	20	6.5	8.0
49-2	F-8SM-28R	183	12	-	2.5	4.0	-	18	25	29.0	6	58	70	88	64	38	45	26	11.0	17.0
49-2	F-8SM-12R	199	12	-	2.5	4.0	-	18	25	49.0	8	58	90	114	81	48	52	26	11.0	17.0
49-2	F-8SM-8.5R	222	16	-	3.0	5.0	-	25	32	46.5	8	58	90	114	81	48	51	26	11.0	17.0

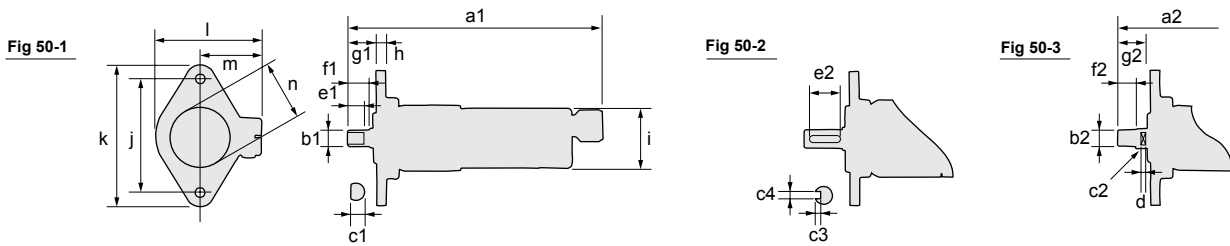

Non-Reversible Type

Fig N°	Model	a1	b1	c1	c3	c4	e1	e2	f1	g1	h	i	j	k	l	m	n	a2	b2	c2	d	f2	g2	
50-1	F-5SM-8.5	152	8	7.0	-	-	10	-	12	20.0	5	32	60	74	55	33	35	-	-	-	-	-	-	-
50-1	F-5SM-2	185	8	7.0	-	-	10	-	12	25.0	5	32	60	74	55	33	35	-	-	-	-	-	-	-
50-1,3	F-6SM-28	167	10	8.5	-	-	12	-	14	19.0	6	38	70	88	64	38	39	169	3/8-24	10	4	12	21.0	
50-1,3	F-6SM-21	167	10	8.5	-	-	12	-	14	19.0	6	38	70	88	64	38	39	167	3/8-24	10	4	12	19.0	
50-1,3	F-6SM-12	178	10	8.5	-	-	12	-	14	18.0	6	38	70	88	64	38	41	178	3/8-24	10	4	12	18.0	
50-1,3	F-6SM-8	200	10	8.5	-	-	12	-	14	36.0	6	38	70	88	64	38	38	200	3/8-24	14	5	12	36.0	
50-1,3	F-6SM-5	200	10	8.5	-	-	12	-	14	36.0	6	38	70	88	64	38	38	200	3/8-24	14	5	12	36.0	
50-1,3	F-6SM-2.5	213	10	8.5	-	-	12	-	14	36.0	6	38	70	88	64	38	38	214	3/8-24	14	5	12	36.0	
50-2,3	F-8SMA-28	181	12	-	2.5	4.0	-	18	25	30.0	6	50	70	88	64	38	43	173	3/8-24	12	5	12	20.0	
50-2,3	F-8SMA-12	200	12	-	2.5	4.0	-	18	25	28.0	8	50	90	114	81	48	51	189	3/8-24	12	5	12	17.0	
50-2,3	F-8SMA-8.5	222	16	-	3.0	5.0	-	25	32	46.5	8	50	90	114	81	48	51	208	1/2-20	14	6	15	32.5	

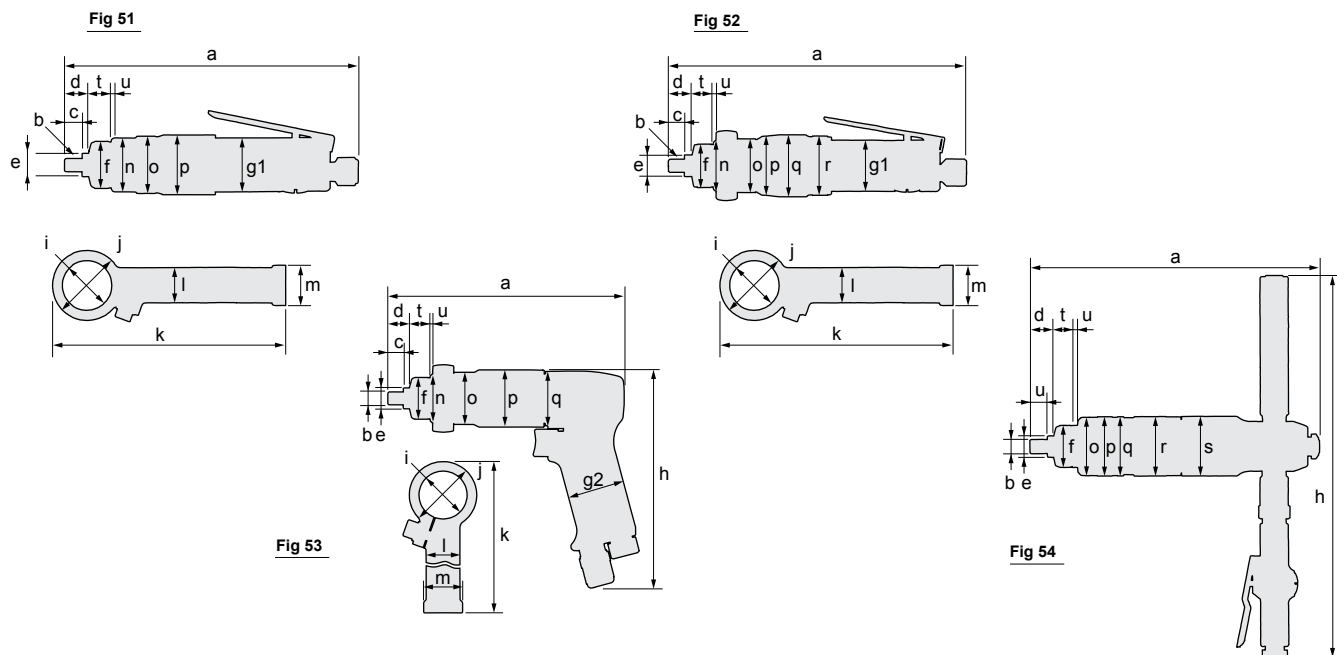

Non-Reversible Type

Fig N°	Model	a	b	c	d	e	f	g1	g2	h	i	j	k	l	m	n	o	p	q	r	s	t	u
51	F-6SE	210	3/8-24	12	17	15.88	32	38	-	-	38	52	176	26	30	38	40	42	-	-	-	16	2
52	F-6SF	225	3/8-24	12	17	15.88	32	38	-	-	38	52	176	26	30	38	40	44	46	44	-	16	2
53	F-6PFX	184	3/8-24	12	17	15.88	32	-	44	170	38	52	176	26	30	38	40	44	42	-	-	16	2
54	F-10MT	266	1/2-20	16	22	19.05	38	-	-	352	-	-	-	-	-	-	53	54	54	54	54	17	5

COMPLEMENTARY RANGE

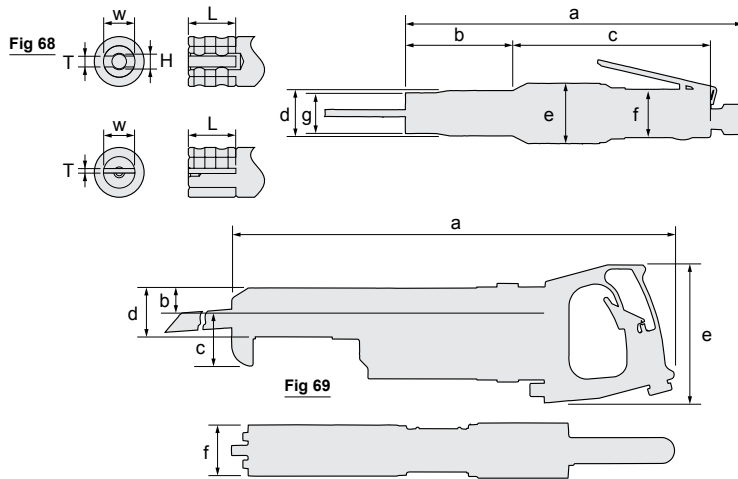

AIR FILES

Fig N°	Model	a	b	c	d	e	f	g	T	W	L	H
68	FRF-4-1F	228	73	133.5	30	40	32	27	4	13	21	6

AIR SAWS

Fig N°	Model	a	b	c	d	e	f	g	T	W	L
68	FRF-4-2F	232	77	133.5	30	40	32	27	2	13	21

Fig N°	Model	a	b	c	d	e	f
69	FRS-45	421	24	50	46	131	48

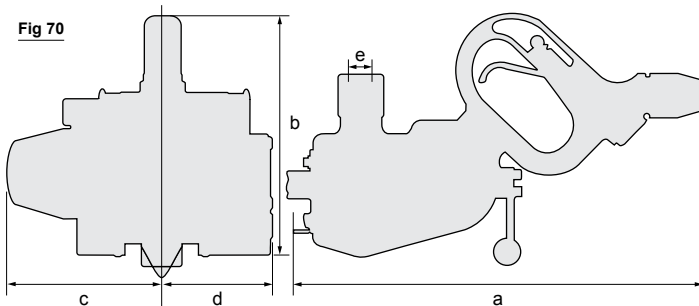

ALUMINUM MILLING MACHINES

Fig N°	Model	a	b	c	d	e
70	FRC-200-1	295	172	111	79	24

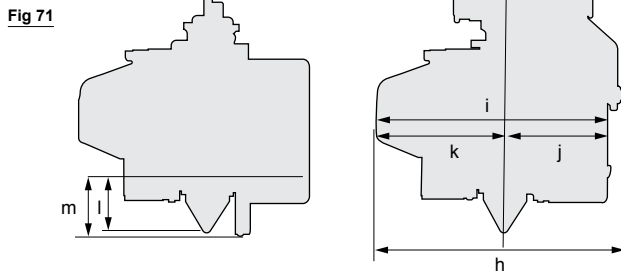

ALUMINUM MILLING MACHINES

Fig N°	Model	a	b	c	d	e	f	g	h	i	j	k	l	m
71	FRC-300-1	376	252	250	79	140.5	30.5	100	240	222	97	125	50	50.5

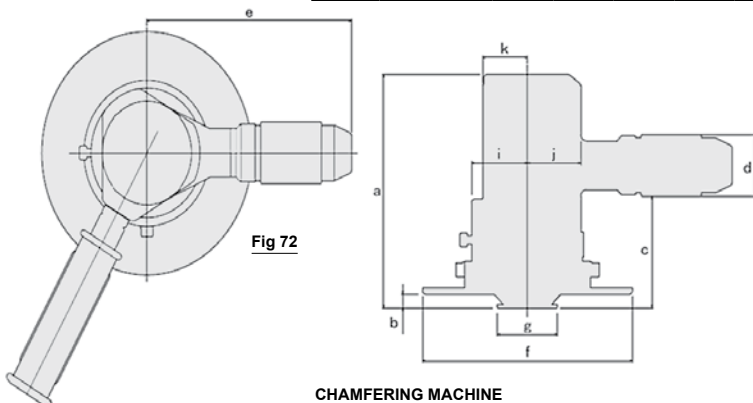

CHAMFERING MACHINE

Fig N°	Model	a	b	c	d	e	f	g	h	i	j	k
72	FBM-2-1	144	8,5	69	38	146	150	43	40	38	32	
	FBM-2-1F	144	8,5	68	40	170	150	43	40	38	32	

COMPLEMENTARY RANGE

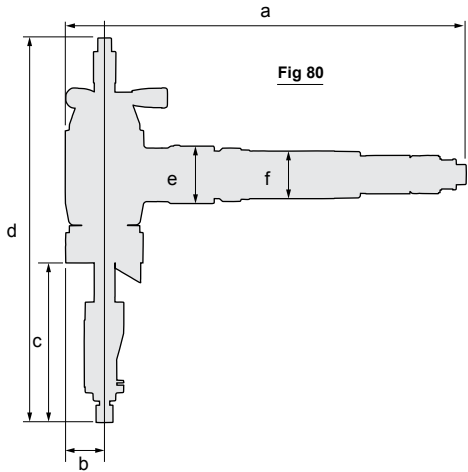

PIPE BEVELLING MACHINES

Fig N°	Model	a	b	c	d	e	f
80	FBM-16-1(S)	261	19.0	51	268	48	42
80	FBM-24-1(S)	278	27.5	67	240	48	42
80	FBM-80A-2(S)	403	39.0	160	388	58	48
80	FBM-80A-3(S)	403	39.0	160	388	58	48
80	FBM-80A-4(S)	403	39.0	160	388	58	48
80	FBM-80A-5(S)	403	39.0	160	388	58	48
80	FBM-80A-6(S)	403	39.0	160	388	58	48
80	FBM-300-2(S)	524	56.0	179	511	74	93
80	FBM-300-3(S)	524	135.0	179	511	74	93
80	FBM-300-4(S)	524	135.0	179	511	74	93

PISTON PUMPS

Fig N°	Model	a	b	c	d	e	f	g
82	FP-11-1	622	137.5	55	PT 1/4	PT 3/4	PT 11/2	84
82	FP-11-2	622	137.5	55	PT 1/4	PT 3/4	PT 11/2	84

SUMP PUMPS

Fig N°	Model	a	b	c	d	e	f
81	FP-7-2	288.6	231.0	9	110	63	PT 3/4
81	FP-20-1	500.0	374.0	52	200	177	W82.5-5
81	FP-35-1	607.0	452.6	50	220	187	W82.5-5

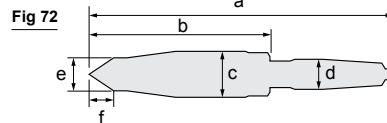
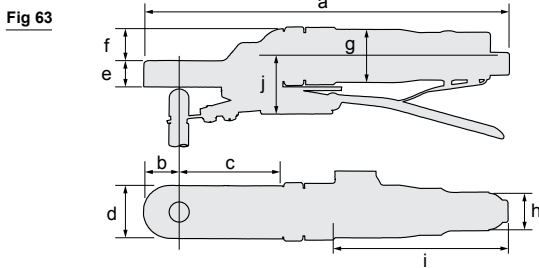
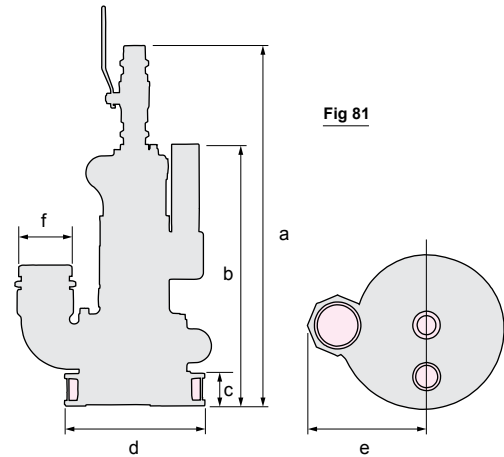
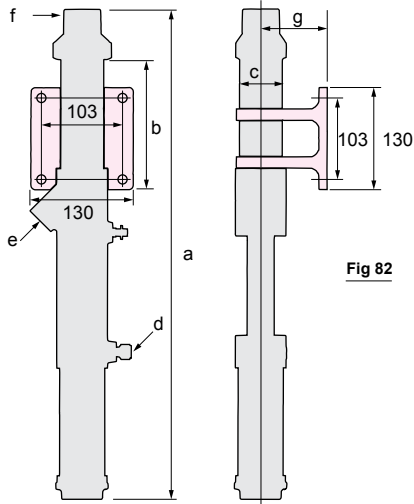

MARKING PEN

Fig N°	Model	a	b	c	d	e	f
72	G-400	147.5	76	19.5	17.5	2.15	1.5

TIP DRESSERS

Fig N°	Model	a	b	c	d	e	f	g	h	i	j
63	FTD-18-1	292	30	87	44	21.5	29	47	-	-	-
63	FTD-18A-1	307	30	83	44	22.0	26	46	30	147	54

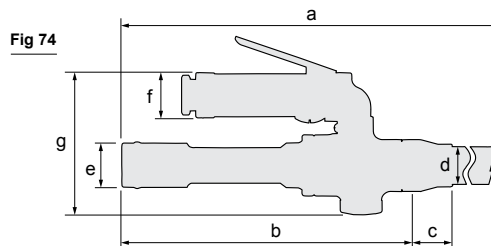
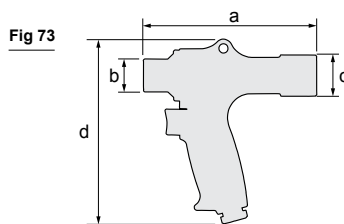

AIR CLEANERS

Fig N°	Model	a	b	c	d	e	f	g
73	AC-200F	145	27	34	153			
74	FJP-500	1020	248.5	32	32	38	38	121

VIBRATION AND NOISE

MODEL	SOUND PRESS.	SOUND POWER	VIBRATION LEVEL ISO 28927 (m/s ²)	
	ISO 15744 - dB(A)		a	k
FG-13-1F	85	96	< 2.5	0.4
FG-13-2	85	96	< 2.5	0.4
FG-13-20	85	96	< 2.5	0.5
FG-13X-1	79	90	< 2.5	0.5
FG-13X-10	79	90	< 2.5	0.5
FG-13X-10F	79	90	< 2.5	0.5
FG-13X-1F	79	90	< 2.5	0.5
FG-13X-2	85	96	< 2.5	0.5
FG-13X-20	85	96	< 2.5	0.5
FG-26H-1	78	89	1.8	0.6
FG-26H-1F	78	89	1.8	0.6
FG-26H-2	78	89	1.8	0.6
FG-26H-2N	78	89	1.8	0.6
FG-26HL-1F	80	91	3	1
FG-26HL-2	80	91	3	1
FG-26HL-2N	80	91	3	1
FG-26HX-1	79	90	< 2.5	1
FG-26HX-1F	79	90	< 2.5	1
FG-26HX-2 6	78	89	< 2.5	1
FG-2VX-1F	81	92	3.6	1.2
FG-3H-1	84.5	95.5	2.71	0.85
FG-3H-1F	80.6	91.6	2.87	0.86
FG-3H-2	80.6	91.6	2.87	0.86
FG-3H-2F	80.6	91.6	2.87	0.86
FG-3H-5	82.4	93.4	2.93	0.93
FG-3H-5F	82.4	93.4	2.93	0.93
FG-3H-6	82	93	2.93	0.93
FG-3HL-1	82.5	93.5	3.12	0.94
FG-3HL-1A	82.5	93.5	3.52	1.07
FG-3HL-1F	82.5	93.5	3.1	0.90
FG-3HY-1	79.9	90.9	2.56	0.83
FG-3HY-1A	79.9	90.9	2.6	0.80
FG-3VX-1F	72.5	83.5	< 2.5	0.80
FG-3VX-2F	72.5	83.5	< 2.5	0.80
FG-3VX-3F	72.5	83.5	< 2.5	0.80
FG-3VX-6F	72.5	83.5	< 2.5	0.80
FG-4H-1	82.7	93.7	< 2.5	0.75
FG-4H-1F	82.7	93.7	3.21	1.67
FG-4H-2	82.7	93.7	3.21	1.67
FG-4H-2F	82.7	93.7	3.21	1.67
FG-4HL-1	80.9	91.9	2.6	0.80
FG-4HL-1A	80.9	91.9	2.6	0.80
FG-4HL-1F	80.9	91.9	2.6	0.80
FG-4VA-1	90	101	< 2.5	0.60
FG-4VA-2	90	101	< 2.5	0.60
FG-50H-1	79	90	< 2.5	0.7
FG-50H-1F	79	90	< 2.5	0.7
FG-50H-2	79	90	< 2.5	0.7
FG-50H-2N	79	90	< 2.5	0.7
FG-50H-3	79	90	< 2.5	0.7
FG-50HX-1	79	90	< 2.5	0.7
FG-50HX-1F	79	90	< 2.5	0.7
FG-50HX-2	79	90	< 2.5	0.7
FG-50L-1	83.6	94.6	3.3	1.80
FG-50L-1A	83.6	94.6	3.3	1.80
FG-50L-1BF	83.6	94.6	3.3	1.80
FG-50Y-1	85.9	96.9	3.3	1.80
FG-50Y-1A	85.9	96.9	3.3	1.80
FG-50Y-1BF	85.9	96.9	3.3	1.80
FG-5H-1	79.5	90.5	< 2.5	0.54
FG-5H-1M	79.5	90.5	< 2.5	0.54
FG-5H-2	79.5	90.5	< 2.5	0.30
FG-5H-2M	79.5	90.5	< 2.5	0.30
FG-5H-3	75.8	86.8	1.09	0.38
FG-5HL-1	82.8	93.8	< 2.6	0.30
FG-5HL-11	90.1	101.1	4.84	1.48
FG-5HL-11A	90.1	101.1	4.84	1.48
FG-5HL-13	82.8	93.8	4.84	1.48
FG-5HL-13A	82.8	93.8	4.84	1.48
FG-5HL-1A	90.1	101.1	6.7	3.50
FG-5HL-2	82.8	93.8	< 2.5	0.30
FG-5HL-2A	82.8	93.8	< 2.5	0.30
FG-5HL-2M	82.8	93.8	< 2.5	0.30
FG-5PX-1	84	95	< 2.5	0.51
FG-6H-1	83.3	94.3	< 2.5	1.27
FG-6H-1M	83.3	94.3	< 2.5	1.27
FG-8H-1	86.7	97.7	< 2.5	0.30
FG-8H-1C	86.7	97.7	< 2.5	0.30
FG-8H-1M EC	86.7	97.7	< 2.5	0.30
FG-8H-2	88.2	99.2	< 2.5	0.30
FG-8H-2M	88.2	99.2	< 2.5	0.30
FJP-500 E	98	109	< 2.5	
FL-11-1	85.3	96.3	< 2.5	0.70
FL-13-1	83.9	94.9	4.10	2.10
FL-4-1	76	87	< 2.5	0.80
FL-4D-1	76	87	< 2.5	0.60
FL-4D-10	76	87	< 2.5	0.60
FL-4S-1	72.1	83.1	< 2.5	0.80
FL-4SD-1	72.1	83.1	3.00	1.40
FL-4SD-10	72.1	83.1	3.00	1.40
FL-5-1	79.2	90.2	< 2.5	0.40
FL-5D-1	79.2	90.2	< 2.5	0.70
FL-5D-10	79.2	90.2	< 2.5	0.70
FL-5S-1 BF	79.2	90.2	4.30	2.20
FL-5SD-1	79.2	90.2	< 2.5	0.70
FL-5SD-10	79.2	90.2	< 2.5	0.70
FL-6-1	82.2	93.2	< 2.5	0.60
FL-6D-1	82.2	93.2	< 2.5	0.70
FL-6D-10	82.2	93.2	< 2.5	0.70
FL-6S-1	79.8	90.8	5.20	2.40
FL-6SD-1	79.8	90.8	4.90	2.30

MODEL	SOUND PRESS.	SOUND POWER	VIBRATION LEVEL ISO 28927 (m/s ²)	
	ISO 15744 - dB(A)		a	k
FL-6SD-10	79.8	90.8	4.90	2.30
FL-7-1	83.6	94.6	< 2.5	0.60
FL-9-1	79.3	90.3	3.40	1.30
FLT-11-2	85.1	96.1	3.90	1.80
FLT-11-2L	85.1	96.1	< 2.5	0.70
FLT-13-2	83.2	94.2	4.90	2.40
FLT-13-2L	83.2	94.2	4.90	2.40
FLT-20S-1	91	102	6.34	3.07
FLT-4-2	74.7	85.7	< 2.5	0.40
FLT-4-2L	70.8	81.8	< 2.5	0.30
FLT-4D-2	74.7	85.7	< 2.5	0.70
FLT-4D-20	74.7	85.7	< 2.5	0.70
FLT-4D-20L	70.8	81.8	< 2.5	0.30
FLT-4D-2L	70.8	81.8	< 2.5	0.30
FLT-4S-1	76.7	87.7	3.70	2.30
FLT-4SD-1	76.7	87.7	< 2.5	1.00
FLT-4SD-10	76.7	87.7	< 2.5	1.00
FLT-5-2	79.1	90.1	< 2.5	0.80
FLT-5-2L	79.2	90.2	< 2.5	1.00
FLT-5D-2	79.1	90.1	< 2.5	0.70
FLT-5D-20	79.1	90.1	< 2.5	0.70
FLT-5D-20L	75	86	< 2.5	0.70
FLT-5D-2L	75	86	< 2.5	0.70
FLT-5S-1	79.9	90.9	3.40	1.60
FLT-5SD-1	79.9	90.9	3.70	2.00
FLT-5SD-10	79.9	90.9	3.70	2.00
FLT-6-2	79.2	90.2	< 2.5	0.80
FLT-6-2L	74.4	85.4	< 2.5	0.53
FLT-6D-2	79.2	90.2	< 2.5	0.80
FLT-6D-20	79.2	90.2	< 2.5	0.80
FLT-6D-20L	74.4	85.4	< 2.5	0.80
FLT-6D-2L	74.4	85.4	< 2.5	0.80
FLT-6S-1	78.8	89.8	6.20	2.10
FLT-6SD-1	78.8	89.8	4.60	2.20
FLT-6SD-10	78.8	89.8	4.60	2.20
FLT-7-2	80.7	91.7	< 2.5	0.90
FLT-7-2L	80.7	91.7	< 2.5	0.90
FLT-9-2	79.5	90.5	3.70	1.50
FLT-9-2L	79.8	90.8	< 2.5	0.60
FNS-2	99.2	110.2	8	2.5
FNS-2-1F	99.2	110.2	8	2.5
FNS-2P	98.5	109.5	7.4	2.3
FNS-2P-1F	98.5	109.5	7.4	2.3
FOR-125B-E	81	92	3	1.3
FOR-125BF-M EC	81	92	3	1.3
FOR-125B-M	81	92	3	1.3
FOR-150BF-E	81	92	3	1.3
FOR-150BF-M	81	92	3	1.3
FOR-150B-M	81	92	3	1.3
FOS-175B-M	81	92	3	1.3
FOS-175T-M	81	92	3	1.3
FOS-230B-E	81	92	3	1.3
FOS-230T-E	81	92	3	1.3
FOW-10-1	90	101	< 2.5	0.30
FOW-10-2	90.4	101.4	< 2.5	0.60
FP-11-1	89	78	3	1.4
FP-11-2	89	78	3	1.4
FP-20-1	89	78	3	1.4
FP-35-1	89	78	3	1.4
FP-7-2	89	78	3	1.4
FPT-110-1	72	83	< 2.5	0.50
FPT-110D-1	72	83	< 2.5	0.50
FPT-110D-10	72	83	< 2.5	0.50
FPT-110S-1 BF	72	83	< 2.5	0.50
FPT-110SD-1	72	83	< 2.5	0.50
FPT-110SD-10	72	83	3.50	1.10
FPT-1660-1	89	100	7.10	3.30
FPT-770S-1	82	93	4.60	2.20
FPT-770SC-1	82	93	4.60	2.20
FPW-110-1	72	83	< 2.5	0.50
FPW-110D-1	72	83	< 2.5	0.50
FPW-110D-10	72	83	< 2.5	0.50
FPW-110S-1	71.6	82.6	2.80	0.90
FPW-110SD-1	71.6	82.6	3.00	0.90
FPW-110SD-10	71.6	82.6	3.00	0.90
FPW-1660-1	89	100	7.10	3.30
FPW-2220S-1	91.3	102.3	6.34	3.07
FPW-770S-1	82	93	2.20	1.40
FPW-770SC-1	82	93	2.20	1.40
FR-18B	94.9	105.9	19.4	5.9
FR-18B-2F	94.9	105.9	19.4	5.9
FR-18L	94.9	105.9	19.4	5.9
FR-18L-2F	94.9	105.9	19.4	5.9
FR-22B	93.7	104.7	19.4	6.1
FR-22B N	93.7	104.7	19.4	6.1
FR-22B-2F	93.7	104.7	19.4	6.1
FR-22L	93.7	104.7	19.4	6.1
FR-22L-2F	93.7	104.7	19.4	6.1
FR-22L-2F EC	93.7	104.7	19.4	6.1
FR-25B	93.7	104.7	22.3	7.4
FR-25B-2F	93.7	104.7	22.3	7.4
FR-25L	93.7	104.7	22.3	7.4
FR-25L-2F	93.7	104.7	22.3	7.4
FR-32	95.8	106.8	25.8	7.8
FR-32-2F	95.8	106.8	25.8	7.8
FRC-200-1	104	115	< 2.5	0.6
FRC-300-1	107	118	2.5	0.8
FRD-100R-1	110	121	< 2.5	0.80
FRD-12Z-1	89.1	100.1	< 2.5	0.50
FRD-12Z-1C	89.1	100.1	< 2.5	0.50
FRD-16Z-1	90	101	< 2.5	0.48

VIBRATION AND NOISE

MODEL	SOUND PRESS.	SOUND POWER	VIBRATION LEVEL ISO 28927 (m/s ²)	
	ISO 15744 - dB(A)		a	k
FRD-16Z-1C	90	101	< 2.5	0.48
FRD-20R-21	97.7	108.7	3.80	1.20
FRD-20R-21S	97.7	108.7	3.80	1.20
FRD-20R-22	97.7	108.7	3.80	1.20
FRD-20R-22S	97.7	108.7	3.80	1.20
FRD-23R-21	97.7	108.7	3.80	1.20
FRD-23R-21S	97.7	108.7	3.80	1.20
FRD-23R-22	97.7	108.7	3.80	1.20
FRD-23R-22S	97.7	108.7	3.80	1.20
FRD-25R-11	97.7	108.7	3.80	1.20
FRD-28R-11	97.7	108.7	3.80	1.20
FRD-28R-11S	97.7	108.7	3.80	1.20
FRD-32R-11	107.4	118.4	< 2.5	0.80
FRD-32R-11S	107.4	118.4	< 2.5	0.80
FRD-32R-12	107.4	118.4	< 2.5	0.80
FRD-32R-12S	107.4	118.4	< 2.5	0.80
FRD-40R-11	110	121	< 2.5	0.80
FRD-40R-11S	110	121	< 2.5	0.80
FRD-50R-11	110	121	< 2.5	0.80
FRD-50R-11S	110	121	< 2.5	0.80
FRD-5P-1	75.2	86.2	< 2.5	0.53
FRD-5S-1	85.1	96.1	< 2.5	0.73
FRD-5S-1F	85.1	96.1	< 2.5	0.73
FRD-5S-2T	85.1	96.1	3.00	0.90
FRD-65R-1	110	121	< 2.5	0.90
FRD-65R-1S	110	121	< 2.5	0.90
FRD-6PH-2	73	83.7	< 2.5	0.74
FRD-6PH-3	72.6	83.6	< 2.5	1.03
FRD-6PH-5	71	82	< 2.5	1.08
FRD-6PH-5	71	82	< 2.5	1.08
FRD-6PH-7	72.7	83.7	< 2.5	0.74
FRD-6PX-1T	71	82	< 2.5	1.08
FRD-6S-1T	71	82	< 2.5	1.08
FRD-6S-2	71	82	2.60	0.79
FRD-6S-2F	71	82	2.60	0.79
FRD-6S-3	92	103	2.70	0.83
FRD-6S-3F	92	103	2.70	0.83
FRD-6S-5	85.8	96.8	2.90	0.91
FRD-6S-5F	85.8	96.8	2.90	0.91
FRD-6S-7	90.9	101.9	4.30	1.32
FRD-6S-7F	90.9	101.9	4.30	1.32
FRD-75R-1	110	121	< 2.5	0.80
FRD-75R-1S	110	121	< 2.5	0.80
FRD-8PX-1	82	93	< 2.5	0.51
FRD-8PX-2	82	93	< 2.5	0.56
FRD-8PX-3	81.9	92.3	< 2.5	0.57
FRF-4-1	90.8	79.8	8.12	2.52
FRF-4-1F	90.8	79.8	8.12	2.52
FRF-4-2	90.8	79.8	8.12	2.52
FRF-4-2F	90.8	79.8	8.12	2.52
FRH-3-1	91	102	8.1	2.5
FRH-3-2	90.9	101.9	6.3	1.9
FRH-6-1	90.9	101.9	5.6	1.7
FRH-6-2	90.9	101.9	5.6	1.7
FRH-6A-1	101	112	11.8	3.5
FRH-6A-2	101.4	112.4	11.8	3.5
FRS-45	92	82	10.4	3.1
FRW-10N-2	89.5	100.5	< 2.5	0.70
FRW-13N-3	91	102	< 2.5	0.60
FRW-13N-4	91	102	< 2.5	0.70
FRW-6NX-3	85.2	96.2	< 2.5	0.60
FRW-6NX-3A	85.2	96.2	< 2.5	0.60
FRW-6NX-4	89	100	3.5	1.20
FRW-6NX-4A	89	100	3.5	1.20
FRW-8NX-2	89.7	100.7	< 2.5	0.60
FRW-8NX-2A 10	89.7	100.7	< 2.5	0.60
FS-2A	88	99	4.9	6.9
FS-2A-1F	88	99	4.9	6.9
FT-13Z-1C	89	100	< 2.5	0.5
FT-6BX-1	71	82	< 2.5	0.4
FT-6P-1	71	82	< 2.5	0.6
FT-8PX-1	82	93	< 2.5	0.4
FTD-18-1	94.7	83.7	4.65	1.5
FTD-18A-1	96.4	85.4	3.67	1.5
FV-7-1M	89	100	6.3	2.1
FV-7-2M	89	100	2.9	0.9
FV-7-4M	93	104	4.94	1.52
FV-9BH-1M	93	104	3.04	0.91
FV-9BH-4M	89	100	< 2.5	0.55
FW-100-1	107	118	4.5	1.6
FW-10PH-1	92.6	103.6	5	1.6
FW-10PH-2	95.7	106.7	5.7	1.7
FW-10SX-5	87.8	98.8	4.2	1.3
FW-14PH-1	92.1	103.1	4.2	1.3
FW-14PH-2	92.1	103.1	4.2	1.3
FW-14PH-3	95.4	106.4	4.2	1.3
FW-14SX-5	90	101	3.1	1
FW-190P-1	91	102	8.4	2.7
FW-250-1	93.9	104.9	8.8	3.7
FW-250-1C	93.9	104.9	8.8	3.7
FW-250-2	93.9	104.9	6.9	2.1

MODEL	SOUND PRESS.	SOUND POWER	VIBRATION LEVEL ISO 28927 (m/s ²)	
	ISO 15744 - dB(A)		a	k
FW-250-2C	93.9	104.9	6.9	2.1
FW-250P-1	98.2	109.2	9.2	3
FW-250P-2	98.2	109.2	10.3	3.2
FW-320-1	92.5	103.5	13.3	4.3
FW-320-1C	92.5	103.5	13.3	4.3
FW-320-1CL	92.5	103.5	13.3	4.3
FW-320-1L	92.5	103.5	13.3	4.3
FW-320P-1	99.9	110.9	20.1	6.2
FW-330-1	100	111	8.4	2.7
FW-330-1C	100	111	8.4	2.7
FW-330-1CL	102	113	9.2	3
FW-330-1L	102	113	9.2	3
FW-330P-1	97	108	8.9	2.8
FW-420-1	97.5	108.5	13.7	4.4
FW-420-1C	97.5	108.5	13.7	4.4
FW-420-1CL	97.5	108.5	13.7	4.4
FW-420-2	97.5	108.5	13.7	4.4
FW-420-2C	97.5	108.5	13.7	4.4
FW-44PAD-2	77.4	88.4	5.2	1.6
FW-44PAD-20	77.4	88.4	5.2	1.6
FW-44SA-1 P	85.9	96.9	5.5	1.7
FW-44SAD-1	85.9	96.9	5.2	1.7
FW-44SAD-10	85.9	96.9	5.2	1.7
FW-50-7	103.5	114.5	4.7	1.7
FW-5PX-6	88.8	99.8	3.1	1.2
FW-5PXD-6	88.8	99.8	4	1.2
FW-5PXD-60	88.8	99.8	4	1.2
FW-5SXD-7	82.2	93.2	9.5	2.8
FW-5SXD-70	82.2	93.2	9.5	2.8
FW-5SXD-8	80.5	91.5	9.4	2.8
FW-5SXD-80	80.5	91.5	9.4	2.8
FW-66PA-2	78.2	89.2	6.5	1.9
FW-66PAD-2	78.2	89.2	4.5	1.4
FW-66PAD-20	78.2	89.2	4.5	1.4
FW-66SA-1	83.1	94.1	7.6	2.3
FW-66SAD-1	83.1	94.1	6.6	2
FW-6PH-1	95.1	106.1	4.5	1.4
FW-6PH-11	95.1	106.1	9	2.7
FW-6PHD-1	95.1	106.1	5.3	1.7
FW-6PL-1	90.8	101.8	4.8	1.5
FW-6PLD-1	90.8	101.8	4.7	1.4
FW-6PM-1	94.3	105.3	4.8	1.6
FW-6PMD-1	94.3	105.3	4.6	1.5
FW-6PMD-10	94.3	105.3	4.6	1.5
FW-6PX-5	94.2	105.2	4.2	1.3
FW-6PX-6	94.2	105.2	3.7	1.2
FW-6PXD-6	94.2	105.2	4.1	1.4
FW-6PXD-60	94.2	105.2	4.1	1.4
FW-6SCX-6	93.2	104.2	8.9	2.8
FW-6SX-5	94.6	105.6	5	1.5
FW-6SX-6	95	106	5.3	1.6
FW-6SXD-6	92.1	103.1	7.2	2.2
FW-6SXD-60	92.1	103.1	7.2	2.2
FW-75-7	107	118	4.5	1.5
FW-88P-1	94	105	4.5	1.4
FW-8PH-3	94.2	105.2	5.1	1.6
FW-8SCH-2	91.5	102.5	7.4	2.3
FW-8SH-2	95	106	6.3	1.9
G-400	79	90	5.1	2.4
OB-75L-E	81	92	3	1.3
OB-75L-M	81	92	3	1.3
TURBO-100	85	96	< 2.5	2
TURBO-100A	85	96	< 2.5	1.7

Fuji Tools follows a policy of continuous product improvement. Specifications and descriptions are thus subject to change without notice. Please contact your Fuji representative for the latest product information.

INDEX

MODELS	RANGE	PAGE	MODELS	RANGE	PAGE	MODELS	RANGE	PAGE
AC-200F	Air Cleaners	102	FA-6C-9M	Angle Grinders	57	FG-13-10F	Die Grinders	46
DA-125C-E	Orbital Sanders	62	FA-6C-20	Angle Grinders	58	FG-13-1F	Die Grinders	46
DA-125C-M	Orbital Sanders	62	FA-7C-1	Angle Grinders	57	FG-13-2	Die Grinders	46
DA-125L-E	Orbital Sanders	62	FA-7C-21	Angle Grinders	58	FG-13-20	Die Grinders	46
DA-125L-M	Orbital Sanders	62	FA-7C-3	Angle Grinders	57	FG-13X-1	Die Grinders	46
DA-125T-E	Orbital Sanders	62	FA-7C-3M	Angle Grinders	57	FG-13X-10	Die Grinders	46
DA-125T-M	Orbital Sanders	62	FA-7E-1V	Angle Grinders	57	FG-13X-10F	Die Grinders	46
F-10MT	Air Motors	92	FA-7E-1VF	Angle Grinders	57	FG-13X-1F	Die Grinders	46
F-14CN	Corner Drills	77	FA-7E-2V	Angle Grinders	57	FG-13X-2	Die Grinders	46
F-14CN-1S	Corner Drills	77	FA-7E-3V	Angle Grinders	57	FG-13X-20	Die Grinders	46
F-14CN-2	Corner Drills	77	FA-7E-4V	Angle Grinders	57	FG-26H-1	Die Grinders	47
F-14CN-2S	Corner Drills	77	FA-7E-5V	Angle Grinders	57	FG-26H-1F	Die Grinders	47
F-22RCN E	Corner Drills	77	FA-7E-5VF	Angle Sanders	60	FG-26H-2	Die Grinders	47
F-22RCN-1S	Corner Drills	77	FA-7E-6VF	Angle Grinders	57	FG-26H-2N	Die Grinders	47
F-22RCR	Corner Drills	77	FA-7E-7VF	Angle Sanders	60	FG-26HL-1F	Die Grinders	47
F-22RCR-1S	Corner Drills	77	FA-7E-8VF	Angle Grinders	57	FG-26HL-2	Die Grinders	47
F-32RCN	Corner Drills	77	FA-7E-9VF	Angle Grinders	57	FG-26HL-2N	Die Grinders	47
F-32RCN-1S	Corner Drills	77	FA-9C-1	Angle Grinders	58	FG-26HX-1	Die Grinders	47
F-32RCNS	Corner Drills	77	FA-9C-2	Angle Grinders	58	FG-26HX-1F	Die Grinders	47
F-32RCNS-1S	Corner Drills	77	FA-9C-2M	Angle Grinders	58	FG-26HX-2	Die Grinders	47
F-32RCR	Corner Drills	77	FA-9C-4	Angle Grinders	58	FG-2VX-1F	Die Grinders	49
F-32RCR-1S	Corner Drills	77	FA-9C-4M	Angle Grinders	58	FG-3H-1	Straight grinders	50
F-SSM-2	Air Motors	93	FBM-16-1	Pipe Beveling Machines	98	FG-3H-1F	Straight grinders	50
F-SSM-2R	Air Motors	92	FBM-16-1S	Pipe Beveling Machines	98	FG-3H-2	Straight grinders	50
F-SSM-8.5	Air Motors	93	FBM-2-1	Chamfering Machines	97	FG-3H-2F	Straight grinders	50
F-SSM-8.5R	Air Motors	92	FBM-2-1F	Chamfering Machines	97	FG-3H-5	Straight grinders	50
F-6SE	Air Motors	92	FBM-24-1	Pipe Beveling Machines	98	FG-3H-5F	Straight grinders	50
F-6SF	Air Motors	92	FBM-24-1S	Pipe Beveling Machines	98	FG-3H-6	Straight grinders	49
F-6SM-12	Air Motors	93	FBM-300-2	Pipe Beveling Machines	98	FG-3HL-1	Straight grinders	51
F-6SM-12 TH	Air Motors	93	FBM-300-3	Pipe Beveling Machines	98	FG-3HL-1A	Straight grinders	51
F-6SM-12R	Air Motors	92	FBM-300-4	Pipe Beveling Machines	98	FG-3HL-1F	Straight grinders	52
F-6SM-2.5	Air Motors	93	FBM-80A-1	Pipe Beveling Machines	98	FG-3HY-1	Straight grinders	51
F-6SM-2.5R	Air Motors	92	FBM-80A-1S	Pipe Beveling Machines	98	FG-3HY-1A	Straight grinders	52
F-6SM-21	Air Motors	93	FBM-80A-2	Pipe Beveling Machines	98	FG-3VX-1F	Straight grinders	49
F-6SM-21R	Air Motors	92	FBM-80A-3	Pipe Beveling Machines	98	FG-3VX-2F	Straight grinders	49
F-6SM-21R EC	Air Motors	92	FBM-80A-3S	Pipe Beveling Machines	98	FG-3VX-3F	Straight grinders	49
F-6SM-28	Air Motors	93	FBM-80A-4	Pipe Beveling Machines	98	FG-3VX-6F	Straight grinders	49
F-6SM-28R	Air Motors	92	FBM-80A-4S	Pipe Beveling Machines	98	FG-4H-1	Straight grinders	50
F-6SM-5	Air Motors	93	FBM-80A-5	Pipe Beveling Machines	98	FG-4H-1F	Straight grinders	50
F-6SM-5R	Air Motors	92	FBM-80A-6	Pipe Beveling Machines	98	FG-4H-2	Straight grinders	50
F-6SM-8	Air Motors	93	FBM-80A-6S	Pipe Beveling Machines	98	FG-4H-2F	Straight grinders	50
F-6SM-8R	Air Motors	92	FC-01-3	Calking Hammers	85	FG-4HL-1	Straight grinders	51
F-8SM-12R	Air Motors	92	FC-01-4	Calking Hammers	85	FG-4HL-1F	Straight grinders	51
F-8SM-28R	Air Motors	92	FC-01SA-H	Calking Hammers	85	FG-4VA-1	Straight grinders	49
F-8SM-8.5R	Air Motors	92	FC-01SA-R	Calking Hammers	85	FG-4VA-2	Straight grinders	49
F-8SM-8.5R TH	Air Motors	92	FC-1Z-1	Calking Hammers	85	FG-50H-1	Die Grinders	48
F-8SMA-12	Air Motors	93	FC-1Z-2	Calking Hammers	85	FG-50H-1F	Die Grinders	48
F-8SMA-12 TH	Air Motors	93	FC-2Z-1	Calking Hammers	85	FG-50H-2	Die Grinders	48
F-8SMA-28	Air Motors	93	FC-2Z-2	Calking Hammers	85	FG-50H-2N	Die Grinders	48
F-8SMA-28 TH	Air Motors	93	FC-3Z-1	Calking Hammers	85	FG-50H-3	Die Grinders	48
F-8SMA-8.5	Air Motors	93	FC-3Z-2	Calking Hammers	85	FG-50HX-1	Die Grinders	48
F-8SMA-8.5 TH	Air Motors	93	FC-4Z-1	Calking Hammers	85	FG-50HX-1F	Die Grinders	48
FA-150K-20	Angle Sanders	60	FC-4Z-2	Calking Hammers	85	FG-50HX-2	Die Grinders	48
FA-150K-30	Angle Sanders	60	FCD-100R-11(S)	Corner Drills	77	FG-50L-1	Straight grinders	51
FA-150KG-7	Angle Sanders	60	FCD-10X-1	Corner Drills	76	FG-50L-1A	Straight grinders	52
FA-2C-1	Angle Grinders	54	FCD-10X-1F	Corner Drills	76	FG-50L-1BF	Straight grinders	51
FA-2C-1BF	Angle Grinders	54	FCD-23R-11(S)	Corner Drills	77	FG-50Y-1	Straight grinders	51
FA-2C-2	Die Grinders	53	FCD-23R-12(S)	Corner Drills	77	FG-50Y-1A	Straight grinders	52
FA-2C-2BF	Die Grinders	53	FCD-32R-11(S)	Corner Drills	77	FG-50Y-1BF	Straight grinders	51
FA-2C-30	Die Grinders	53	FCD-50R-11(S)	Corner Drills	77	FG-5H-1	Straight grinders	50
FA-2C-30F	Die Grinders	53	FCD-6A-1	Corner Drills	76	FG-5H-1M	Straight grinders	50
FA-2CX-1	Angle Grinders	54	FCD-6B-1	Corner Drills	76	FG-5H-2	Straight grinders	50
FA-2CX-1BF	Angle Grinders	54	FCD-6B-1F	Corner Drills	76	FG-5H-2M	Straight grinders	50
FA-2CX-2	Die Grinders	53	FCD-6EX-3	Corner Drills	76	FG-5H-3	Straight grinders	50
FA-2CX-2BF	Die Grinders	53	FCD-6EX-4	Corner Drills	76	FG-5HL-1	Straight grinders	51
FA-2CX-30	Die Grinders	53	FCD-6X-1	Corner Drills	76	FG-5HL-11	Straight grinders	51
FA-2CX-30F	Die Grinders	53	FCD-6X-1F	Corner Drills	76	FG-5HL-11A	Straight grinders	52
FA-30-2	Angle Grinders	55	FCD-6X-2 E	Corner Drills	76	FG-5HL-13	Straight grinders	51
FA-30-2F	Angle Grinders	55	FCD-6X-2F	Corner Drills	76	FG-5HL-13A	Straight grinders	52
FA-30X-2	Angle Grinders	55	FCD-75R-11	Corner Drills	77	FG-5HL-1A	Straight grinders	52
FA-30X-2F	Angle Grinders	55	FCD-75R-11S	Corner Drills	77	FG-5HL-2	Straight grinders	51
FA-3CK-1	Angle Sanders	60	FCH-20	Chipping Hammers	83	FG-5HL-2A	Straight grinders	52
FA-3CK-1	Angle Sanders	60	FCH-20-1F	Chipping Hammers	83	FG-5HL-2M	Straight grinders	51
FA-3CK-2	Angle Grinders	55	FCH-20F	Chipping Hammers	83	FG-5PX-1	Disc Sanders	60
FA-40-1	Angle Grinders	55	FCH-20F-1F	Chipping Hammers	83	FG-6H-1	Straight grinders	50
FA-40-1F	Angle Grinders	55	FCH-25	Chipping Hammers	83	FG-6H-1M	Straight grinders	50
FA-4C-1	Angle Grinders	55	FCH-25-1F	Chipping Hammers	83	FG-8H-1	Straight grinders	50
FA-4C-1F	Angle Grinders	55	FCH-25B	Chipping Hammers	83	FG-8H-1C	Straight grinders	50
FA-4C-3	Angle Grinders	55	FCH-25B-1F	Chipping Hammers	83	FG-8H-1M	Straight grinders	50
FA-5C-1	Angle Grinders	56	FD-4	Screwdrivers	36	FG-8H-2	Straight grinders	50
FA-5C-4	Angle Grinders	56	FD-4P	Screwdrivers	36	FG-8H-2M	Straight grinders	50
FA-5C-4F	Angle Grinders	56	FD-5	Screwdrivers	36	FJP-500	Air Cleaners	102
FA-5C-5	Angle Sanders	60	FD-5P	Screwdrivers	36	FJT-10-1	Testers	16
FA-5C-5	Angle Sanders	60	FET-11-1	Pulse Wrenches	19	FJT-16-1	Testers	16
FA-5E-11V	Angle Grinders	58	FET-13-1	Pulse Wrenches	19	FJT-5-1	Testers	16
FA-5E-13VF	Angle Grinders	56	FET-16-1	Pulse Wrenches	19	FL-11-1	Pulse Wrenches	23
FA-5E-15VF	Angle Grinders	56	FET-4-1	Pulse Wrenches	19	FL-13-1	Pulse Wrenches	23
FA-5E-16VF	Angle Grinders	56	FET-4D-1	Pulse Wrenches	19	FL-4-1	Pulse Wrenches	23
FA-5E-1F	Angle Grinders	56	FET-5-1	Pulse Wrenches	19	FL-4D-1	Pulse Wrenches	23
FA-5E-1V	Angle Grinders	56	FET-5D-1	Pulse Wrenches	19	FL-4D-10	Pulse Wrenches	23
FA-5E-1VF	Angle Grinders	56	FET-6-1	Pulse Wrenches	19	FL-4S-1	Pulse Wrenches	23
FA-5E-2F	Angle Grinders	56	FET-6D-1	Pulse Wrenches	19	FL-4SD-1	Pulse Wrenches	23
FA-5E-2V	Angle Grinders	56	FET-7-1	Pulse Wrenches	19	FL-4SD-10	Pulse Wrenches	23
FA-5E-2VF	Angle Grinders	56	FET-9-1	Pulse Wrenches	19	FL-5-1	Pulse Wrenches	23
FA-5E-6VF	Angle Sanders	60	FG-06-1	Pencil grinder	44	FL-5D-1	Pulse Wrenches	23
FA-5E-6VF	Angle Sanders	60	FG-06S-1	Pencil grinder	44	FL-5D-10	Pulse Wrenches	23
FA-5E-8V	Angle Grinders	58	FG-12U-1	Die Grinders	45	FL-5S-1	Pulse Wrenches	23
FA-6C-1	Angle Grinders	57	FG-12U-1F	Die Grinders	45	FL-5SD-1	Pulse Wrenches	23
FA-6C-10	Angle Grinders	57	FG-12U-2	Die Grinders	45	FL-5SD-10	Pulse Wrenches	23
FA-6C-12	Angle Grinders	57	FG-12UX-1	Die Grinders	45	FL-6-1	Pulse Wrenches	23
FA-6C-12M	Angle Grinders	57	FG-12UX-1F	Die Grinders	45	FL-6D-1	Pulse Wrenches	23
FA-6C-6M	Angle Grinders	57	FG-12UX-2	Die Grinders	45	FL-6D-10	Pulse Wrenches	23
FA-6C-7	Angle Grinders	58	FG-13-1	Die Grinders	46	FL-6SD-1	Pulse Wrenches	23
FA-6C-8M	Angle Grinders	57	FG-13-10	Die Grinders	46	FL-6SD-10	Pulse Wrenches	23

INDEX

MODELS	RANGE	PAGE
FL-7-1	Pulse Wrenches	23
FL-9-1	Pulse Wrenches	23
FLT-11-2	Pulse Wrenches	26
FLT-11-2L	Pulse Wrenches	28
FLT-13-2	Pulse Wrenches	26
FLT-13-2L	Pulse Wrenches	28
FLT-20S-1	Pulse Wrenches	26
FLT-4-2	Pulse Wrenches	26
FLT-4-2L	Pulse Wrenches	28
FLT-4D-2	Pulse Wrenches	26
FLT-4D-20	Pulse Wrenches	27
FLT-4D-20L	Pulse Wrenches	28
FLT-4S-1	Pulse Wrenches	26
FLT-4SD-1	Pulse Wrenches	26
FLT-4SD-10	Pulse Wrenches	26
FLT-5-2	Pulse Wrenches	26
FLT-5-2L	Pulse Wrenches	28
FLT-5D-2	Pulse Wrenches	26
FLT-5D-20	Pulse Wrenches	27
FLT-5D-20L	Pulse Wrenches	28
FLT-5D-2L	Pulse Wrenches	28
FLT-5S-1	Pulse Wrenches	26
FLT-5SD-1	Pulse Wrenches	26
FLT-5SD-10	Pulse Wrenches	26
FLT-6-2	Pulse Wrenches	26
FLT-6-2L	Pulse Wrenches	28
FLT-6D-2	Pulse Wrenches	26
FLT-6D-20	Pulse Wrenches	27
FLT-6D-20L	Pulse Wrenches	28
FLT-6D-2L	Pulse Wrenches	28
FLT-6S-1	Pulse Wrenches	26
FLT-6SD-1	Pulse Wrenches	26
FLT-6SD-10	Pulse Wrenches	26
FLT-7-2	Pulse Wrenches	26
FLT-7-2L	Pulse Wrenches	28
FLT-9-2	Pulse Wrenches	26
FLT-9-2L	Pulse Wrenches	28
FNS-2	Needle Scalers	86
FNS-2-1F	Needle Scalers	86
FNS-2P	Needle Scalers	86
FNS-2P-1F	Needle Scalers	86
FOR-125B-E	Orbital Sanders	62
FOR-125B-M	Orbital Sanders	62
FOR-150BF-E	Orbital Sanders	62
FOR-150BF-M	Orbital Sanders	62
FOR-150B-M	Orbital Sanders	62
FOS-175B-M	Orbital Sanders	62
FOS-175T-M	Orbital Sanders	62
FOS-230B-E	Orbital Sanders	62
FOS-230T-E	Orbital Sanders	62
FOW-10-1	Open-End Wrenches	37
FOW-10-2	Open-End Wrenches	37
FP-11-1	Piston Pumps	100
FP-11-2	Piston Pumps	100
FP-20-1	Sump Pumps	100
FP-35-1	Sump Pumps	100
FP-7-2	Sump Pumps	100
FPT-110-1	Pulse Wrenches	29
FPT-110D-1	Pulse Wrenches	29
FPT-110D-10	Pulse Wrenches	29
FPT-110S-1	Pulse Wrenches	29
FPT-110SD-1	Pulse Wrenches	29
FPT-110SD-10	Pulse Wrenches	29
FPT-1660-1	Pulse Wrenches	29
FPT-770S-1	Pulse Wrenches	29
FPT-770SC-1	Pulse Wrenches	29
FPW-110-1	Pulse Wrenches	24
FPW-110D-1	Pulse Wrenches	24
FPW-110D-10	Pulse Wrenches	24
FPW-110S-1	Pulse Wrenches	24
FPW-110SD-1	Pulse Wrenches	24
FPW-1660-1	Pulse Wrenches	24
FPW-2220S-1	Pulse Wrenches	24
FPW-770S-1	Pulse Wrenches	24
FPW-770SC-1	Pulse Wrenches	24
FR-18B	Sand Rammers	87
FR-18B-2F	Sand Rammers	87
FR-18L	Sand Rammers	87
FR-18L-2F	Sand Rammers	87
FR-22B	Sand Rammers	87
FR-22B-2F	Sand Rammers	87
FR-22L	Sand Rammers	87
FR-22L-2F	Sand Rammers	87
FR-25B	Sand Rammers	87
FR-25B-2F	Sand Rammers	87
FR-25L	Sand Rammers	87
FR-25L-2F	Sand Rammers	87
FR-32	Sand Rammers	87
FR-32-2F	Sand Rammers	87
FRC-200-1	Aluminum Milling Machines	97
FRC-300-1	Aluminum Milling Machines	97
FRD-100R-1	Drills	75
FRD-12Z-1	Drills	75
FRD-12Z-1C	Drills	75
FRD-16Z-1	Drills	75
FRD-16Z-1C	Drills	75
FRD-20R-21	Drills	75
FRD-20R-21S	Drills	75
FRD-20R-22	Drills	75
FRD-20R-22S	Drills	75
FRD-23R-21	Drills	75
FRD-23R-21S	Drills	75

MODELS	RANGE	PAGE
FRD-23R-22	Drills	75
FRD-23R-22S	Drills	75
FRD-25R-11	Drills	75
FRD-25R-11S	Drills	75
FRD-28R-11	Drills	75
FRD-28R-11S	Drills	75
FRD-32R-11	Drills	75
FRD-32R-11S	Drills	75
FRD-32R-12	Drills	75
FRD-32R-12S	Drills	75
FRD-40R-11	Drills	75
FRD-40R-11S	Drills	75
FRD-50R-11	Drills	75
FRD-50R-11S	Drills	75
FRD-5P-1	Drills	74
FRD-5S-1	Drills	73
FRD-5S-1F	Drills	73
FRD-5S-2T	Drills	73
FRD-65R-1	Drills	75
FRD-65R-1S	Drills	75
FRD-6PH-2	Drills	74
FRD-6PH-3	Drills	74
FRD-6PH-5	Drills	74
FRD-6PH-7	Drills	74
FRD-6PX-1T	Drills	74
FRD-6S-1T	Drills	73
FRD-6S-2	Drills	73
FRD-6S-2F	Drills	73
FRD-6S-3	Drills	73
FRD-6S-3F	Drills	73
FRD-6S-5	Drills	73
FRD-6S-5F	Drills	73
FRD-6S-7	Drills	73
FRD-6S-7F	Drills	73
FRD-75R-1	Drills	75
FRD-75R-1S	Drills	75
FRD-8PX-1 E	Drills	74
FRD-8PX-2 E	Drills	74
FRD-8PX-3 E	Drills	74
FRF-4-1	Air Files	96
FRF-4-1F	Air Files	96
FRF-4-2	Air Saws	96
FRF-4-2F	Air Saws	96
FRH-3-1	Percussive Tools	84
FRH-3-2	Percussive Tools	84
FRH-6-1	Percussive Tools	84
FRH-6-2	Percussive Tools	84
FRH-6A-1	Percussive Tools	84
FRH-6A-2	Percussive Tools	84
FRS-45	Air Saws	96
FRW-10N-2	Ratchets	38
FRW-13N-3	Ratchets	38
FRW-13N-4	Ratchets	38
FRW-6NX-3	Ratchets	38
FRW-6NX-3A	Ratchets	38
FRW-6NX-4	Ratchets	38
FRW-6NX-4A	Ratchets	38
FRW-8NX-2	Ratchets	38
FRW-8NX-2A	Ratchets	38
FS-2A	Percussive Tools	87
FS-2A-1F	Percussive Tools	87
FT-13Z-1	Tappers	80
FT-13Z-1C	Tappers	80
FT-6BX-1	Tappers	80
FT-6P-1	Tappers	80
FT-8PX-1	Tappers	80
FTD-18-1	Tip Dressers	101
FTD-18A-1	Tip Dressers	101
FV-7-1M	Vertical Grinders	59
FV-7-2M	Vertical Grinders	59
FV-7-4M	Vertical Grinders	59
FV-9BH-1M	Vertical Grinders	59
FV-9BH-4M	Vertical Grinders	59
FW-100-1	Impact Wrenches	34
FW-10PH-1	Impact Wrenches	31
FW-10PH-2	Impact Wrenches	31
FW-10SX-5	Impact Wrenches	32
FW-14PH-1	Impact Wrenches	31
FW-14PH-2	Impact Wrenches	31
FW-14PH-3	Impact Wrenches	31
FW-14PX-5	Impact Wrenches	31
FW-14SX-5	Impact Wrenches	32
FW-190P-1	Impact Wrenches	34
FW-250-1	Impact Wrenches	33
FW-250-1C	Impact Wrenches	33
FW-250-2	Impact Wrenches	33
FW-250-2C	Impact Wrenches	33
FW-250P-1	Impact Wrenches	34
FW-250P-2	Impact Wrenches	34
FW-320-1	Impact Wrenches	33
FW-320-1C	Impact Wrenches	33
FW-320-1CL	Impact Wrenches	33
FW-320-1L	Impact Wrenches	33
FW-320P-1	Impact Wrenches	34
FW-330-1	Impact Wrenches	33
FW-330-1C	Impact Wrenches	33
FW-330-1CL	Impact Wrenches	33
FW-330-1L	Impact Wrenches	33
FW-330P-1	Impact Wrenches	34
FW-420-1	Impact Wrenches	33
FW-420-1C	Impact Wrenches	33
FW-420-1CL	Impact Wrenches	33

MODELS	RANGE	PAGE
FW-420-2	Impact Wrenches	33
FW-420-2C	Impact Wrenches	33
FW-44PAD-2	Impact Wrenches	36
FW-44PAD-20	Impact Wrenches	36
FW-44SA-1	Impact Wrenches	30
FW-44SAD-1	Impact Wrenches	35
FW-44SAD-10	Impact Wrenches	35
FW-50-7	Impact Wrenches	34
FW-5PX-6	Impact Wrenches	31
FW-5PXD-6	Impact Wrenches	36
FW-5PXD-60	Impact Wrenches	36
FW-5SXD-7	Impact Wrenches	35
FW-5SXD-70	Impact Wrenches	35
FW-5SXD-8	Impact Wrenches	35
FW-5SXD-80	Impact Wrenches	35
FW-66PA-2	Impact Wrenches	30
FW-66PAD-2	Impact Wrenches	36
FW-66PAD-20	Impact Wrenches	36
FW-66SA-1	Impact Wrenches	30
FW-66SAD-1	Impact Wrenches	35
FW-6PH-1	Impact Wrenches	31
FW-6PH-11	Impact Wrenches	31
FW-6PHD-1	Impact Wrenches	36
FW-6PL-1	Impact Wrenches	31
FW-6PLD-1	Impact Wrenches	36
FW-6PM-1	Impact Wrenches	31
FW-6PMD-1	Impact Wrenches	36
FW-6PMD-10	Impact Wrenches	36
FW-6PX-5	Impact Wrenches	31
FW-6PXD-6	Impact Wrenches	36
FW-6PXD-60	Impact Wrenches	36
FW-6SCX-6	Impact Wrenches	32
FW-6SX-5	Impact Wrenches	32
FW-6SX-6	Impact Wrenches	32
FW-6SXD-6	Impact Wrenches	35
FW-6SXD-60	Impact Wrenches	35
FW-75-7	Impact Wrenches	34
FW-88P-1	Impact Wrenches	30
FW-8PH-3	Impact Wrenches	31
FW-8SCH-2	Impact Wrenches	32
FW-8SH-2	Impact Wrenches	32
G-400	Marking Pen	102
OB-75L-E	Orbital Sanders	62
OB-75L-M	Orbital Sanders	62
TURBO-100	Die Grinders	44
TURBO-100A 6 E	Die Grinders	44



Fuji



POWER AND PRECISION
IN PERFECT HARMONY

INDUSTRIAL TOOLS FROM FUJI

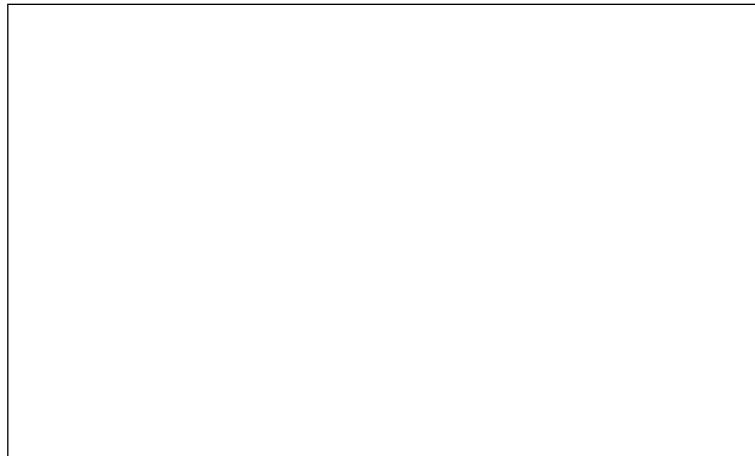

2 - 1 - 14, Kamiji, Higashinari-ku
Osaka 537-0003, JAPAN
www.fujitools.com

Specifications and designs in this catalogue are subject to change without notice



> www.linkedin.com/company/fuji-air-tools