



Industrial & Production Tools



REAL TOOLS FOR REAL WORK.™

Technical Symbols

	Bitholder outer diameter		Drilling		Piston stroke length
	Bitholder inner diameter		External drilling		Piston stroke height
	Collet capacity		Studding		Tool length
	Shank diameter		Spindle attachment		Tool height
	Spindle Thread angle		Maximum torque in reverse		Tool weight
	Thread diameter		Max. free speed		Drilling capacity in steel
	Connection thread		Recommended forward torque range		Tapping capacity in steel
	Air inlet diameter		Spring max.		Reaming capacity in steel
	Minimum hose diameter		Spring low		Wheel diameter
	Bolt capacity		Max. air consumption		Orbital movement
	Bolt head capacity		Blows per minute		Pad diameter
	Torque range peak		Vibration level / uncertainty		Belt sander / size
	Max. chuck/collet capacity		Sound pressure		Communication
	Rivet capacity				Voltage
					Rated Power

Tools Performance Classification

★★★ **Super-duty tools** These tools are designed to tackle the most extreme jobs. Advanced technology gives these tools superior strength and durability across the widest range of applications.
 ★★ **Heavy-duty tools**
 ★ **Maintenance-duty tools**

★★★ **Super-duty tools** The heavy-duty tools are top-quality models that exceed the requirements of highly demanding applications and environments. They are engineered with special features for top power, speed and comfort.
 ★★ **Heavy-duty tools**
 ★ **Maintenance-duty tools**

★★★ **Super-duty tools** Maintenance-duty tools are durable, high-quality, impressively powerful.
 ★★ **Heavy-duty tools**
 ★ **Maintenance-duty tools**

Contents

Cordless Tools

Cordless Precision Bolting	6
Cordless 20V Impact Tools	10
Cordless 12V Impact Tools	12



Cordless Tools

Pneumatic Bolting & Drilling

Selection Chart	16
Bolting Torques	17
Air Impacttools	18
ATEX Certified Air Impacttools	24
Large Drills up to 76 mm capacity Applications	26
Impacttools Accessories	27



Pneumatic Bolting & Drilling

Pneumatic Grinding & Finishing

Selection Chart	32
Air Grinders and Sanders	33
Special Air Grinders/Sanders	42
Air Random Orbital Sanders	44
Accessories	45



Grinding & Finishing

Pneumatic Percussive Tools

Air Impact Riveters	48
Air Hammers and Reciprocating Saws	49
Air Scalers and Needle Scalers	50
Air Chippers	51



Percussive Tools

Airline & Additional Accessories

Air Filters, Regulators and Lubricators	56
Quick Release Couplings, Nipples and Hoses	57
Spring Balancers – Tools Lubricants	59



Accessories

Our engineers know that a cordless tool has to Do the Job, Do it Fast, Do it Every Time.

Cordless Tools

- 6 | Cordless Precision Bolting
- 10 | Cordless 20V Impact Tools
- 12 | Cordless 12V Impact Tools

As a world leader in enhancing productivity, Ingersoll Rand is the only company offering cordless tools specifically engineered for industrial MRO tool users. Our cordless tools deliver portability with the reliability of advanced battery/charger technologies and proven Ingersoll Rand power and durability. With Ingersoll Rand you get cordless tools that work as hard as you. Do the Job, Do it Fast, Do it Every Time.

QXM Cordless Torque Multiplier

The innovative QX Series Cordless Torque Multiplier will reduce your assembly time and cost, while ensuring repeatable accuracy for all torque-critical joints. Designed with a premium gearbox and an efficient, time-tested closed-loop transducer, this tool will fasten the bolt, validate, and record each result, managing your total operation.

Accuracy: Ingersoll Rand's closed-loop transducer control at the heart of the tool delivers precise torque and accurate, traceable results—it's precision where you need it most.

Control: A multi-function display module allowing for quick setup and feedback on every QX Series™ tool. User-programmable configurations such as torque, angle and gang count that reduce the number of tools needed for multiple applications.

Comfort: Cordless and compact, the QX Series™ Torque Multiplier allows operators to move freely without the need of bulky air or hydraulic hoses, compressors, generators or powerpacks. Tethering points to safely secure the tool.



QX Multiplier

Communication: USB standard, wireless communication optional. Data management, process control and the ability to adjust tool configurations (Ethernet, fieldbus and I/O capable).

Versatility: Fast programming that makes the tool adaptable to multiple applications. Cordless and portable to allow operators to move freely around any workplace or environment.

QX Multiplier



40-200Nm
100-500Nm



200-1,000Nm
270-1,350Nm



400-2,000Nm

QX Series™ Torque Multiplier Kit



**Kit includes (1) tool, (2) BL2022 5.0 Ah batteries, (1) BC1121-EU charger and (1) tool bag. Hard case available as a separate option.

QX Series™ Angle Torque Multiplier



Ingersoll Rand offers custom Angle Torque Multiplier tools within the torque range from 16 to 2000Nm. Please contact your sales representative for more details.

Common Bolting Strategies

Torque



Achieve desired torque within high and low limits

Angle



Achieve target rotation within high and low limits

Gang Count



Counts all rundowns to ensure all bolts have been fastened

+ If additional control is needed, Ingersoll Rand's ICS software gives you even more options to adapt to the most complicated bolting applications.

Technical Specifications at 6.2 bar (90 psi) dynamic pressure at inlet

Model No.	MAX nm	1 min rpm	kg	L mm	mm	V	in	Communication
QX Series™ Pistol								
QXC2PT200NPS12	40-200	45	3.62	373	56	20V	3/4"	Via USB Cable Only
QXC2PT500NPS12	100-500	18	3.62	373	56	20V	3/4"	Via USB Cable Only
QXC2PT1000NPS12	200-1,000	9	5.44	419	80	20V	3/4"	Via USB Cable Only
QXC2PT1350NPS16	270-1,350	7	5.44	419	80	20V	1"	Via USB Cable Only
QXC2PT2000NPS16	400-2,000	5	6.80	452	80	20V	1"	Via USB Cable Only
QXX2PT200NPS12	40-200	45	3.62	373	56	20V	3/4"	Wireless Enabled
QXX2PT500NPS12	100-500	18	3.62	373	56	20V	3/4"	Wireless Enabled
QXX2PT1000NPS12	200-1,000	9	5.44	419	80	20V	3/4"	Wireless Enabled
QXX2PT1350NPS16	270-1,350	7	5.44	419	80	20V	1"	Wireless Enabled
QXX2PT2000NPS16	400-2,000	5	6.80	452	80	20V	1"	Wireless Enabled
QX Series™ Pistol Kit*								
QXC2P200S12K2	40-200	45	3.62	373	56	20V	3/4"	Via USB Cable Only
QXC2P500S12K2	100-500	18	3.62	373	56	20V	3/4"	Via USB Cable Only
QXC2P1000S12K2	200-1,000	9	5.44	419	80	20V	3/4"	Via USB Cable Only
QXC2P1350S16K2	270-1,350	7	5.44	419	80	20V	1"	Via USB Cable Only
QXC2P2000S16K2	400-2,000	5	6.80	452	80	20V	1"	Via USB Cable Only
QXX2P200PS12K2	40-200	45	3.62	373	56	20V	3/4"	Wireless Enabled
QXX2P500PS12K2	100-500	18	3.62	373	56	20V	3/4"	Wireless Enabled
QXX2P1000PS12K2	200-1,000	9	5.44	419	80	20V	3/4"	Wireless Enabled
QXX2P1350PS16K2	270-1,350	7	5.44	419	80	20V	1"	Wireless Enabled
QXX2P2000PS16K2	400-2,000	5	6.80	452	80	20V	1"	Wireless Enabled
QX Series™ Angle Wrench								
QXX5A45T0180PS12	16-180	110	4.25	560	150	40V	3/4"	Wireless Enabled
QXX5A45T0270PS12	54-270	77	4.25	560	150	40V	3/4"	Wireless Enabled
QXX2A52T0396PS12	79-395	21	3.54	535	175	20V	3/4"	Wireless Enabled
QXX2A52T0594PS12	119-594	14	4.06	535	175	20V	3/4"	Wireless Enabled
QXX5A52T0880PS12	180-880	23	4.60	560	175	40V	3/4"	Wireless Enabled
QXX5A72T1080PS16	216-1,080	19	5.97	575	195	40V	1"	Wireless Enabled
QXX5A72T1620PS16	324-1,620	13	5.97	575	195	40V	1"	Wireless Enabled

*Kits include bare tool, two (2) BL2022-EU batteries, BC1121-EU charger and TB2 tool bag

Reaction Arms

Ingersoll Rand offers the following variety of reaction arms for different applications. Reaction arms are available in both 52 mm and 72 mm spline drives, depending on the size of the gearbox.

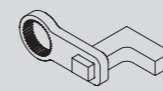

Cranked, 45 or 90 degrees

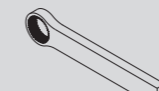

Straight, aluminum or steel (multiple lengths available)

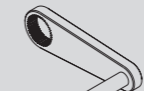
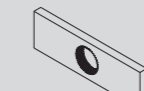

Plate and pin (multiple lengths available)



Double-sided



Sliding slave kit (multiple lengths available)

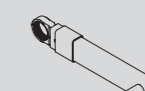

Sliding peg and yoke assembly (multiple lengths available)

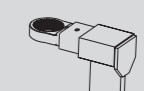

Sliding yoke, paddle and yoke assembly (multiple lengths available)



Blank welding ring

IQV20 Series

As power tools are called on to perform, our cordless IQV20 Series 20-volt tools is specially designed by our engineers for industrial MRO and manufacturing applications.

Performance with high power and long-life 20V lithium-ion battery that delivers max torque.

Durability with robust, patented metal reinforced housing withstands repeated drops.

Versatility as cordless portability delivers performance where you need it the most.



IQV20 Impact Wrenches



Technical Specifications

	Model No.	CPN	V	in	Max. Nm	1 min rpm	1 min bpm	kg	L mm	dB(A)	m/s ² /K ⁽²⁾
Impacttools											
Tool only	W5130	48377840	20	3/8" Hog Ring	245	1,700	2,900	1.60	168	91.0	8.8/2.6
Kit ⁽¹⁾	W5130-K22-EU	47530973001									
Tool only	W5131P	48620819	20	3/8", Pin Detent	215	1,900	2,800	1.60	150	86.0	4.7/1.2
Kit ⁽¹⁾	W5131P-K22-EU	47530975001									
Tool only	W5133	47636405001	20	3/8", Square Hog Ring	500	2,100	3,300	2.40	179	90.0	12.6/1.7
Kit ⁽²⁾	W5133-K22-EU	47637349001									
Tool only	W5133P	47624610001	20	3/8", Pin Retainer	500	2,100	3,300	2.40	179	90.0	12.6/1.7
Tool only	W5150	48620801	20	1/2", Hog Ring	245	1,700	2,900	1.60	168	91.0	8.8/2.6
Kit ⁽¹⁾	W5150-K22-EU	47530977001									
Tool only	W5151P	48620827	20	1/2", Pin Detent	215	1,900	2,800	1.60	154	86.0	4.7/1.2
Kit ⁽¹⁾	W5151P-K22-EU	47530979001									
Tool only	W5153	47636406001	20	1/2", Hog Ring	500	2,100	3,300	2.40	183	90.0	12.6/1.7
Kit ⁽²⁾	W5153-K22-EU	47637362001									
Tool only	W5153P	47624611001	20	1/2", Pin Retainer	400	2,100	3,300	2.10	179	90.0	16.1/2.6
Tool only	W7150EU	48391692	20	1/2", Hog Ring	1,057	1,900	2,300	3.10	238	89.0	12.2/1.8
Kit ⁽¹⁾	W7150EU-K22	47524963001									
Tool only	W7152	47633386001	20	1/2", Hog Ring	1,360	1,900	2,450	3.40	207	95.0	17.0/3.7
Kit ⁽¹⁾	W7152-K22-EU	47633406001									
Tool only	W7152P	47633391001	20	1/2", Pin Retainer	1,360	1,900	2,450	3.40	207	95.0	17.0/3.7
Kit ⁽¹⁾	W7152P-K22-EU	47633407001									
Tool only	W7172	47663441001	20	3/4", Square	1,360	1,900	-	3.50	215	95.0	17.0/3.7
Kit ⁽¹⁾	W7172-K22-EU	47663446001									
Tool only	W7252	47633389001	20	1/2", Hog Ring	1,360	1,900	2,035	3.60	257	95.0	17.2/2.3
Kit ⁽¹⁾	W7252-K22-EU	47633408001									
1/4" Hex Impact Driver											
Tool only	W5111	48620793	20	1/4", Hex	215	1,900	2,800	1.60	154	86.0	4.7/1.2
Kit ⁽¹⁾	W5111-K22-EU	47530971001									

(1) Kits include a carrying case with the tool and 2 Li-Ion batteries (5.0 Ah for K22B or 2.5 Ah for K22) and universal charger
(2) Kits include a carrying case with the tool and 2 Li-Ion batteries (2.5 and 5.0 Ah for K22A) and universal charger
(3) ISO28927 – 3-axis measurement: vibration level/measurement uncertainty.



IQV20 Ratchet & Angle Wrenches

Technical Specifications

	Model No.	CPN	V	in	Max. Nm	1 min rpm	kg	L mm	dB(A)	m/s ² /K ⁽³⁾
Ratchet Wrenches										
Tool only	R3130	48621023								
Kit ⁽¹⁾	R3130-K12-EU	47530966001	20	3/8", Square	73	225	2.00	445	86.0	2.8/0.7
Kit ⁽¹⁾	R3130-K22-EU	47530967001								
Tool only	R3150	48621056								
Kit ⁽¹⁾	R3150-K12-EU	47530968001	20	1/2", Square	73	225	2.00	445	86.0	2.8/0.7
Kit ⁽¹⁾	R3150-K22-EU	47530969001								
Tool only	W5350	47514541001	20	1/2", Hog Ring	245	1,900	2.06	439	85.0	10.3/6.3
Kit	W5350-K12-EU	47530981001								
Tool only	W5330	47514540001	20	3/8", Hog Ring	245	1,900	2.06	439	85.0	10.3/6.3
Kit	W5330-K12-EU	47530980001								

IQV20 Drill/Driver

Technical Specifications

	Model No.	CPN	V	Max. Ø mm	Max. Nm	1 min rpm	kg	L mm	dB(A)	m/s ² /K ⁽³⁾
Drill/Driver										
Tool only	D5140	48489546	20	13	80	500/1,900	2.45	235	75.0	< 2.5
Kit ⁽²⁾	D5140-K22-EU	47530987001								

(1) Kits include a carrying case with the tool, 1 Li-Ion battery 2.5 Ah and universal charger.
(2) Kit includes a carrying case with the tool, 2 Li-Ion batteries 5.0 Ah and universal charger.
(3) ISO28927 – 3-axis measurement: vibration level/measurement uncertainty.



IQV20 Cordless Tools Accessories & other tools

Model No.	CPN	Description	Compatibility
BC1121-EU	47507874001	12/20V Charger	All IQV20 tools
BL2012	47515903001	20 V, 2.5 Ah, Li-Ion battery	All IQV20 tools
BL2022	47515902001	20 V, 5.0 Ah, Li-Ion battery	All IQV20 tools
L5110	48489561	LED Task-light 180 LUX	All IQV20 batteries
W7150-BOOT	48401855	Protective tool boot in vinyl material	W7150EU
W7152-BOOT	47621732001	Protective tool boot in vinyl material	W7152, W7152P
W5130-BOOT	48624753	Protective tool boot in vinyl material	W5130, W5150
W5111-BOOT	47499747001	Protective tool boot in vinyl material	W5131P, W5151P, W5111
LUB5130	47503006	Cordless Grease Gun	LUB5130
LUB5130-K12-EU	47503151001	20V Grease Gun 1 Bat Kit, 2.5AH, EU	LUB5130

IQV12 Series

The IQV12 Series 12-volt tools is offering versatile performance, cordless convenience and rugged durability in a light weight and compact tool combined with an ergonomic design that improve accessibility and minimize the operator fatigue.

Accessibility: the compact, cordless design of every IQV12 Series tool makes accessing tight spaces easier.

Comfort: lightweight design and small handles help minimize fatigue, making tools more ergonomic and comfortable to hold.

Durability: reinforced, chemical and impact resistant housings, designed to withstand tough environments.



D1130

IQV12 Impacttools and Screwdrivers



W1130 (with BL1203)

W1110 (with BL1203)

D1410 (with BL1203)

W1130EU-K2 (1)

Technical Specifications

	Model No.	CPN	V	in	Recom. Nm	Max. Nm	1 min rpm	bpm	kg	mm	dB(A)	m/s ² /K ⁽³⁾
Impacttool												
Tool only	W1130	47500084001	12	3/8", Hog Ring	20-100	135	2,700	3,300	1.04	150	82.0	3.8/2.7
Kit (1)	W1130EU-K2	47500089001										
Tool only	W1120	47500081001	12	1/4", Hog Ring	20-100	135	2,700	3,300	1.03	150	82.0	3.8/2.7
Kit (1)	W1120EU-K2	47500088001										
1/4" Hex Impact Driver												
Tool only	W1110	47500078001	12	1/4", Hex	20-100	135	2,700	3,300	1.05	150	82.0	4.5/3.0
Kit (1)	W1110EU-K2	47500087001										
Screwdriver												
Tool only	D1410	47500114001	12	1/4", Hex	2-20	23	400-1,600	-	0.95	130	64.0	< 2.5
Kit (1)	D1410EU-K2	47500117001										

(1) Kits include a bag with the tool, 2 Li-Ion batteries and universal charger.
(2) ISO28927 - 3-axis measurement: vibration level/measurement uncertainty.



See accessories on following page



R1130 (with BL1203)

R1130EU-K1 kit (1)

D1130 (with BL1203)

D1130EU-K2 (2)

IQV12 Ratchet Wrenches

Technical Specifications

	Model No.	CPN	V	in	Recom. Nm	Max. Nm	1 min rpm	kg	mm	dB(A)	m/s ² /K ⁽³⁾
Ratchet Wrenches											
Tool only	R1120	47500060001	12	1/4" Square	7-34	40	260	0.98	280	86.0	2.8/0.7
Kit (1)	R1120EU-K1	47500064001									
Tool only	R1130	47500062001	12	3/8" Square	7-34	40	260	0.98	280	76.0	< 2.5
Kit (1)	R1130EU-K1	47500065001									

IQV12 Drill/Driver

Technical Specifications

	Model No.	CPN	V	Max. Nm	1 min rpm	kg	mm	dB(A)	m/s ² /K ⁽³⁾
Drill/Driver									
Tool only	D1130	47500112001	12	23	400-1,600	1.10	190	64.0	< 2.5
Kit (2)	D1130EU-K2	47500116001							

IQV12 Specialty Tools

Technical Specifications

	Model No.	CPN	V	mm	mm	1 min rpm	bpm	kg	mm	dB(A)	m/s ² /K ⁽³⁾	
Polisher / Sander												
Tool	G1621	47542795001	12	50 (2")	-	-	2,200	-	1.28	144	67.0	3.0 / 0.8
Kit (2)	G162EU-K2	47540140001										
Belt Sander												
Tool	G1811	47559185001	12	-	-	10x330	7,000	-	1.00	212	67.0	3.0 / 0.8
Kit (2)	G1811EU-K2	47559180001										
Reciprocating Saw												
Tool	C1101	47559324001	12	-	14	-	-	3,300	0.97	298	77.0	17.9 / 7.8
Kit (2)	C1101EU-K2	47559320001										

IQV12 Cordless Tools Accessories

Model No.	CPN	Description	Compatibility
BC1110-EU	47499973001	12/20V Charger	All IQV20 tools
BL1203	24206179	12 V, 2 Ah Li-Ion battery	All IQV12 tools
L1110	47500109001	LED Task-light 180 LUX	BL1203 battery

(1) Kits include a bag with the tool, 1 Li-Ion battery and universal charger.
(2) Kit includes a bag with the tool, 2 Li-Ion batteries and universal charger.
(3) ISO28927 - 3-axis measurement: vibration level/measurement uncertainty.



BC1110-EU Charger

BL1203

L1110

**Performance
Reliability
Durability**



Pneumatic Bolting & Drilling

- 16 | Selection Chart
- 17 | Bolting Torques
- 18 | Air Impactools
- 24 | ATEX Certified Air Impactools
- 26 | Large Drills up to 76 mm capacity
- 27 | Impactools Accessories

Productivity has come a long way since Ingersoll Rand introduced the first Impactool™ in 1934. What has not changed is our reputation for world-class tools that set the industry standard for power, durability, and reliability. Every Impactool bearing the Ingersoll Rand name reflects our commitment to delivering cutting-edge tool designs that work as hard as you do and provide maximum comfort, safety, efficiency, and serviceability. Throughout this catalog, you will find Ingersoll Rand Impactools offering several different impact technologies to best suit your wide range of applications.

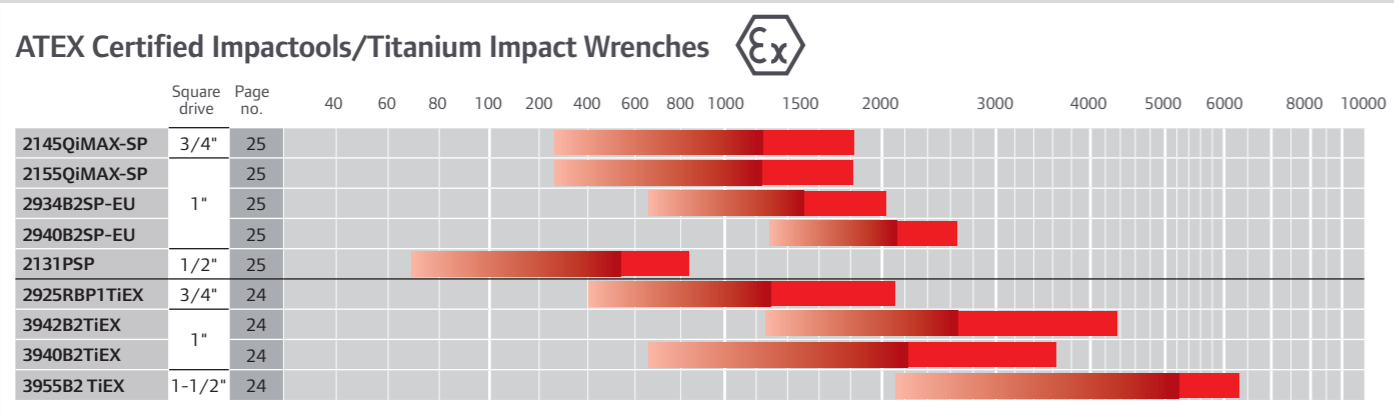
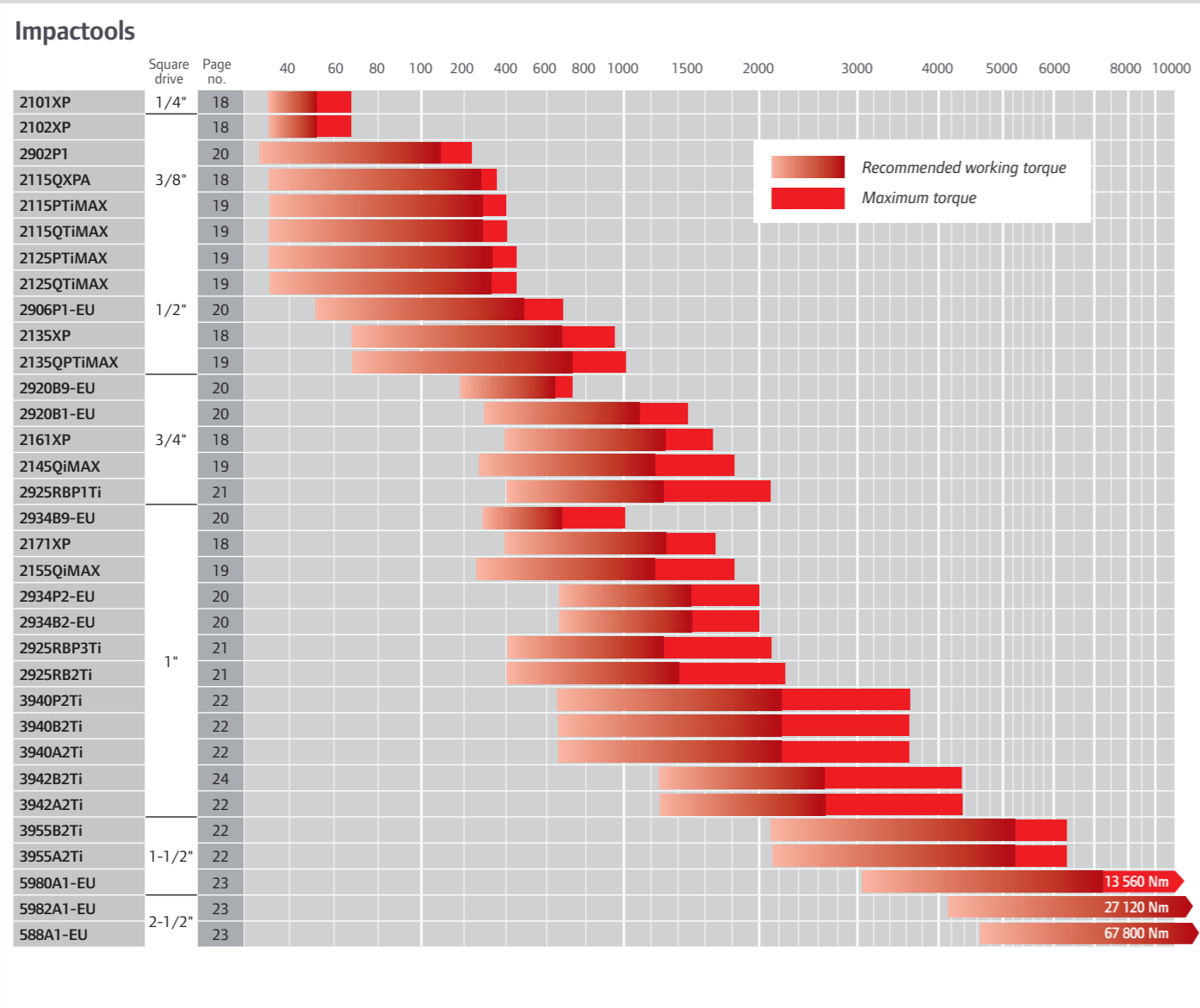

DIN267 Bolt Grade: bolt grade consists of two figures which refer to the following characteristics of the bolt:
1st digit = 10% of breaking load in kg/mm² — **2nd digit** = 10% of ratio between minimum elastic limit and minimum breaking load.

Bolt grade DIN267 →		3.6	4.6	4.8	5.6	5.8	6.8	8.8	10.9	12.9
mm	mm	Maximum torque in Nm								
M4	7	0.85	1.1	1.5	1.4	1.9	2.3	2.9	4.1	4.9
M5	9	1.7	2.2	3.0	2.8	3.7	4.5	6.0	8.5	10
M6	10	2.9	3.8	5.1	4.8	6.4	7.7	10	14	17
M8	13	7.0	9.3	12	12	16	19	25	35	41
M10	17	14	19	25	23	31	37	49	69	83
M12	19	24	32	43	40	54	65	86	120	145
M14	22	39	51	68	64	86	105	135	190	230
M16	24	59	79	105	98	130	155	210	295	355
M18	27	81	110	145	135	180	215	290	405	485
M20	30	115	155	205	190	255	305	410	580	690
M22	32	155	205	275	260	345	415	550	780	930
M24	36	200	265	350	330	440	530	710	1000	1200
M27	41	295	390	520	490	650	780	1050	1500	1800
M30	46	395	530	710	660	880	1050	1450	2000	2400
M33	50	540	720	960	900	1200	1450	1900	2700	3250
M36	55	690	920	1250	1150	1550	1850	2450	3450	4150
M39	60	920	1200	1600	1500	2000	2400	3200	4500	5400
M42	65	1100	1500	1950	1850	2450	2950	3950	5550	6650
M45	70	1400	1850	2450	2300	3100	3700	4950	6950	8350
M48	75	1700	2250	3000	2800	3750	4450	5950	8400	10100
M52	80	2150	2900	3850	3600	4800	5750	7650	10800	12900
M56	85	2700	3600	4800	4500	5950	7150	9550	13400	16100
M60	90	3350	4450	5950	5550	7400	8900	11900	16700	20000
M64	95	4000	5350	7150	6700	8950	10700	14300	20100	24100
M68	100	4850	6500	8650	8100	10800	13000	17300	24300	29100

Impact Mechanisms

Ingersoll Rand Impactools and Wrenches are available in a choice of configurations with straight or pistol grip handles and inside or outside triggers – Square drives from 3/8" to 2-1/2" are offered. They use the most advanced materials and design to provide unequalled power to weight ratios – some tools are specially designed for use in hazardous industrial areas.

Three powerful impact mechanism designs available

Twin Hammer, delivers more power per pound and is less sensitive to air pressure fluctuations than any other design – Smooth, balanced blow – High power-to-weight ratio – Suitable for hard or soft-draw applications. This Ingersoll Rand technology has become the industry standard. An automatic pressure feed grease system supplies grease to the impact mechanism.

Jumbo Hammer, performs similarly to the Twin Hammer but contains only three working parts. An automatic pressure feed grease system supplies grease to the impact mechanism.

Ball & Cam mechanisms are ideal for soft draw applications and are commonly used in larger impacttools.

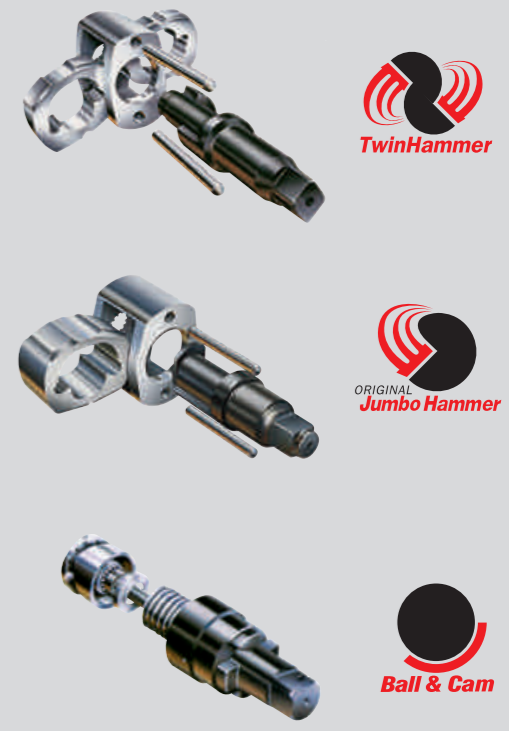

2100XP-Series

Perfect for any maintenance and repair application, the 2100XP Series tools deliver maximum power and control, along with unmatched reliability that comes from more than a century of proven engineering and innovation.

Performance: Ingersoll Rand Twin Hammer impact mechanism is the strongest, most durable and longest life mechanism in the industry.

Control: one-hand forward/reverse switch for easy operation and power regulator.

Comfort: ergonomic handle design and textured finish provide a secure and comfortable grip.



2135XP

Air Impacttools



Technical Specifications at 6.2 bar (90 psi) dynamic pressure at inlet

Model No.	CPN	in	Recom. Nm	Max. Nm	1 min rpm	1 min bpm	kg	L mm	in (NPT)	mm	Max. I/s	dB(A)	m/s ² /K ⁽¹⁾
Air Impacttools/Simple Hammer Mechanism													
2101XPA	47520745001	1/4" Square	34-54	75	14,500	3,650	0.70	175	1/4"	10	4.7	84.8	3.0/1.0
2102XPA	47520747001	3/8" ring type	34-54	75	14,500	3,650	0.70	175	1/4"	10	4.7	84.8	3.0/1.0
Air Impacttools/Twin Hammer Mechanism													
2115QXPA	45632130	3/8" ring type	34-285	370	15,000	1,500	1.13	151	1/4"	10	8.0	94.0	7.5/1.8
2135QXPA	47517913001	1/2" ring type	68-680	1,057	9,800	1,250	1.80	187	1/4"	10	NA	90.7	13.3/4.6
2135QXPA	47518811001	1/2" Pin Anvil	949	1,057	11,000	1,250	1.80	189	1/4"	10	NA	90.7	13.3/4.6
2161XP	01372085	3/4" ring type	407-1,356	1,695	6,000	1,025	5.35	216	3/8"	13	21.5	94.7	9.8/1.8
2171XP	01378165	1" ring type	407-1,356	1,695	6,000	1,025	5.47	226	3/8"	13	21.5	94.7	10.3/1.3

(1) ISO28927 - 3-axis measurement: vibration level/measurement uncertainty.

2100XP-Series Accessories

Model No.	CPN	Description	Compatibility
2115M-BOOT	45602174	Protective tool boot in vinyl material	2115QXPA
2130-BOOT	45505369	Protective tool boot in vinyl material	2130XP
2135M-BOOT	45545977	Protective tool boot in vinyl material	2135QXPA
2161-BOOT	45505401	Protective tool boot in vinyl material	2161XP, 2171XP

2100MAX-Series

The 2100MAX Series are premium quality tools for the most demanding applications. Engineered with special features for maximum power, control and reliability. Their new design includes enhanced controls for even greater comfort and convenience.

Performance: Ingersoll Rand Twin Hammer impact mechanism is the strongest, most durable and longest life mechanism in the industry.

Control: feather-touch trigger, wider range of power regulator settings in forward, always maximum power in reverse.

Comfort: ergonomic composite housing is lightweight, protects from cold air and offers great operator comfort. Patented Quiet Tool technology - reduces sound levels caused by air pulsating through the impact motor.



2235QiMAX



2100MAX-Series power and reverse controls

Technical Specifications at 6.2 bar (90 psi) dynamic pressure at inlet

Model No.	CPN	in	Recom. Nm	Max. Nm	1 min rpm	1 min bpm	kg	L mm	in (NPT)	mm	Max. I/s	dB(A)	m/s ² /K ⁽¹⁾
Air Impacttools/Twin Hammer Mechanism													
2115PTiMAX	45587540	3/8" pin type	34-312	407	15,000	1,500	1.13	151	1/4"	10	8.0	93.2	7.5/1.8
2115QTiMAX	45587326	3/8" ring type	34-312	407	15,000	1,500	1.13	151	1/4"	10	8.0	93.2	7.5/1.8
2125PTiMAX	45587565	1/2" pin type	34-340	450	15,000	1,500	1.14	155	1/4"	10	8.0	93.2	7.5/1.8
2125QTiMAX	45587524	1/2" ring type	34-340	450	15,000	1,500	1.14	155	1/4"	10	8.0	93.2	7.5/1.8
2135QTiMAX	45535572	1/2" pin type	68-746	1,057	9,800	1,250	1.84	187	1/4"	10	11.3	94.2	13.3/4.6
2235QTiMAX	47517574001	1/2" ring type	90-1180	1,220	8,500	1,220	2.10	193	1/4"	10	11.3	91.9	9.0/2.8
2145QiMAX	45624327	3/4" ring type	271-1220	1,830	1,150	1,150	3.35	217	3/8"	13	15.1	96.3	8.7/2.7
2155QiMAX	47123450	1" ring type	271-1220	1,830	1,150	1,150	3.40	225	3/8"	13	15.1	96.3	8.7/2.7

(1) ISO28927 - 3-axis measurement: vibration level/measurement uncertainty.

2100MAX-Series Accessories

Model No.	CPN	Description	Compatibility
2115M-BOOT	45602174	Protective tool boot in vinyl material	2115PTiMAX, 2115QTiMAX, 2125PTiMAX, 2125QTiMAX
2235M-BOOT	47520153001	Protective tool boot in vinyl material	2235QTiMAX, 2235QTiMAX
2145M-BOOT	48385033	Protective tool boot in vinyl material	2145QiMAX, 2155QiMAX

2235M-BOOT



2900-Series

The 2900 Series is designed with durability in mind, from the vanes turning the motor to the hammer frames and anvil for intensive and heavy-duty industrial maintenance and production applications.

Control: 5-position power regulator helps adjusting the power to the application on 2902P1 and 2906P1. 90° angle drive available on 2920 and 2934 impacttools.

Reliability: Ingersoll Rand Twin Hammer impact mechanism (except 2902P1). Pressure-fed mechanism lubrication.

Comfort: integral muffler reducing operator's fatigue. Ergonomic auxiliary handle provides excellent maneuverability.

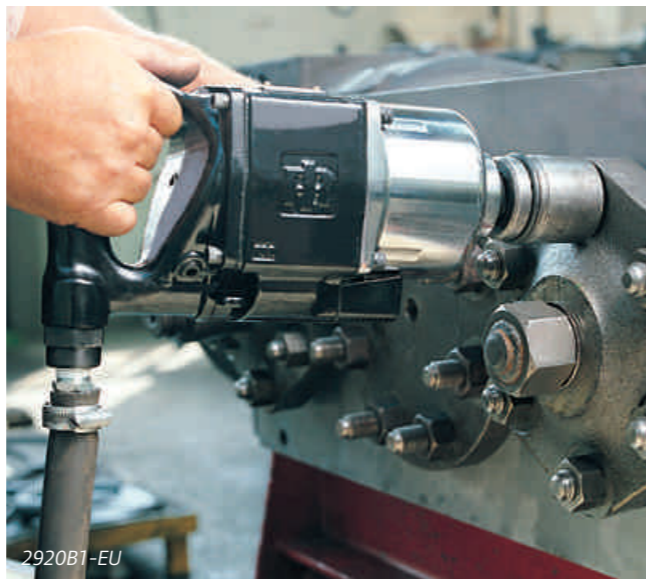

2920B1-EU



Technical Specifications at 6.2 bar (90 psi) dynamic pressure at inlet

Model No.	CPN	Profile	in(1)	Recom. Nm	Max. Nm	1 min rpm	1 min bpm	kg	L mm	in (NPT)	mm	Max. l/s	dB(A)	m/s ² /K(2)
Air Impactool/Jumbo Hammer Mechanism														
2902P1	01198498	P	3/8" pin type	27-163	244	10,000	1,500	1.25	140	1/4"	10	7.0	79.7	7.6/1.8
Air Impactool/Twin Hammer Mechanism														
2906P1-EU	01337609	P	1/2" pin type	54-475	678	5,000	1,200	2.72	175	1/4"	10	10.8	83.7	7.2/0.8
2934P2-EU	01337989	P	1" hole type	678-1,490	2,034	5,300	825	9.07	219	1/2"	19	22.1	92.4	18.3/5.3
2920B1-EU	01338045	B	3/4" hole type	339-1,085	1,492	5,000	950	5.98	318	3/8"	13	17.0	87.9	19.9/6.6
2934B2-EU	01337591	B	1" hole type	678-1,490	2,034	6,600	750	8.39	286	1/2"	19	22.1	97.9	18.8/3.7
2920B9-EU	01338896	B9	3/4" hole type	203-678	746	5,000	950	10.75	445	3/8"	13	17.0	91.8	19.9/6.6
2934B9-EU	01338227	B9	1" hole type	339-678	1,017	5,300	780	16.2	473	1/2"	19	22.1	96.2	30.8/10.2

(1) Hole-type square drives for use with socket retaining rings (see description page 28).

(2) ISO28927 - 3-axis measurement: vibration level/measurement uncertainty.

2900-Series Accessories

Model No.	CPN	Description	Compatibility
212-BOOT	45505344	Protective tool boot in vinyl material	2902P1

2925-Series

The 2925 Series comes with an unbeatable feature list which meets the most demanding requirements for enhanced performance and unbeatable durability in super heavy industrial applications.

Performance: Ingersoll Rand Twin Hammer impact mechanism.

Durability: Titanium hammer case is lightweight with unparalleled durability. Corrode-X™-corrosion resistant treatment on internal parts guards against contaminants in the air system.

Adaptability: the motor can be easily converted to provide maximum torque in forward direction for fastening applications.

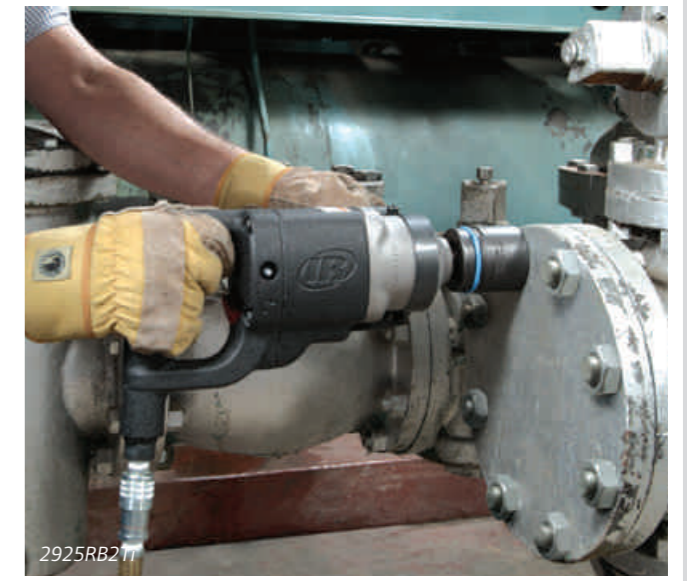

2925RB2Ti

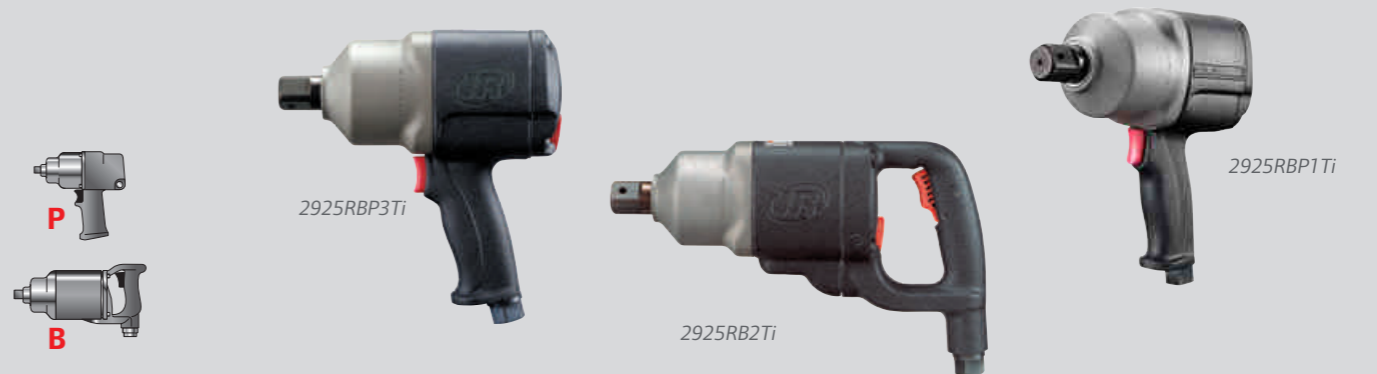

Technical Specifications at 6.2 bar (90 psi) dynamic pressure at inlet

Model No.	CPN	Profile	in(1)	Recom. Nm	Max. Nm	1 min rpm	1 min bpm	kg	L mm	in (NPT)	mm	Max. l/s	dB(A)	m/s ² /K(2)
Air Impactool/Twin Hammer Mechanism														
2925RBP1Ti	80147036	P	3/4" hole type	1,763	2,169	5,200	1,050	5.44	226	3/8"	13	28.3	95.9	10.5
2925RBP3Ti	80147044	P	1" hole type	407-1,288	2,169	5,200	1,050	5.54	230	3/8"	13	28.0	98.0	10.5/1.0
2925RB2Ti	80147051	B	1" hole type	407-1,356	2,304	6,500	900	6.89	334	3/8"	13	28.0	100.2	9.8/1.3

(1) Hole-type square drives for use with socket retaining rings (see description page 28).

(2) ISO28927 - 3-axis measurement: vibration level/measurement uncertainty.



See our impact sockets and impact socket sets on pages 27-29

3900-Series

The revolutionary design of the 3900 Series gives more power and greater durability than any competitive model. From the inside out, the comprehensive list of features and benefits makes it the only choice for professionals in the oil and gas, power generation and other demanding industries.

Performance: 6,780 Nm (5,000 ft-lb) of maximum torque in reverse. Twin Hammer impact mechanism. High-performance motor package includes 7-vane rotor and bronze end-plates – can be easily converted to provide maximum torque in forward direction for fastening applications.

Durability: lightweight titanium hammer case with unparalleled durability. Corrosion- and wear-resistant bronze end-plates.



5000-Series

The 5000 Series is designed with durability in mind, from the vanes turning the motor to the hammer frames and anvils. Proprietary hardening and treatment processes and excellence in manufacturing all add up to the longest lasting, hardest hitting impact tools in the business.

Performance: for fast removal and tightening of large fasteners. 588A1-EU model is the most powerful Impactool in the world.

Convenience: portable, easy to handle or suspend with vertical and horizontal hangers.

Durability: built-in lubricator and high resistance hammer case.

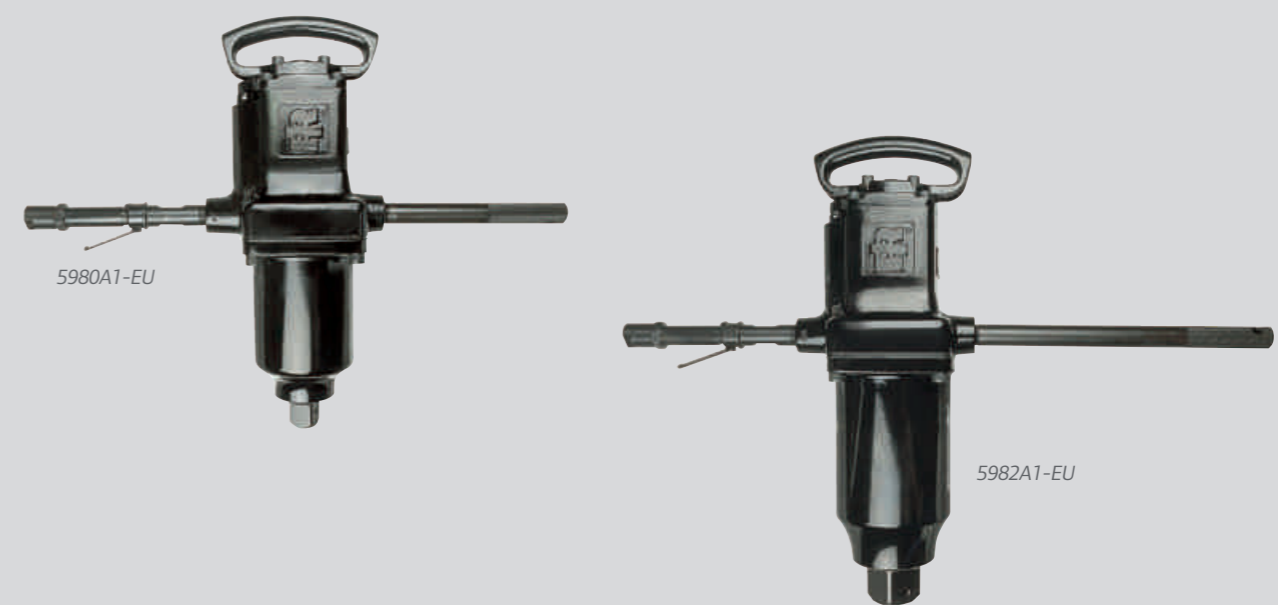

Technical Specifications at 6.2 bar (90 psi) dynamic pressure at inlet

Model No.	CPN	Profile	in(1)	Recom. Nm	Max. Nm	1 min rpm	1 min bpm	kg	L mm	in (NPT)	mm	Max. l/s	dB(A)	m/s ² /K(2)
Air Impactool/Twin Hammer Mechanism														
3940P2Ti	80162597	P	1" hole type	678-2,237	3,729	5,300	800	9.3	256	1/2"	19	35	97.8	14.2/2.0
3940A2Ti	80150402	A	1" hole type	678-2,237	3,729	6,000	800	9.6	341	1/2"	19	35	106.6	13.1/1.6
3942A2Ti	80152960	A	1" hole type	1,356-2,644	4,407	5,000	850	10.5	361	1/2"	19	44	103.4	16.9/4.6
3955A2Ti	80153562	A	1-1/2" hole type	2,170-5,290	6,780	2,750	700	15.7	423	1/2"	19	37	102.0	20.8/8.5
3940B2Ti	10568301	B	1" hole type	678-2,237	3,729	6,000	800	9.6	341	1/2"	19	35	100.6	13.1/1.6
3942B2Ti	80152978	B	1" hole type	1,356-2,644	4,407	5,000	850	10.5	361	1/2"	19	44	102.0	16.9/4.6
3955B2Ti	80151103	B	1-1/2" hole type	2,170-5,290	6,780	2,750	700	15.7	423	1/2"	19	37	102.0	20.8/8.5

(1) Hole-type square drives for use with socket retaining rings (See description page 28).

(2) ISO28927 – 3-axis measurement: vibration level/measurement uncertainty.

Technical Specifications at 6.2 bar (90 psi) dynamic pressure at inlet

Model No.	CPN	in(1)	Recom. Nm	Max. Nm	1 min rpm	1 min bpm	kg	L mm	in (NPT)	mm	Max. l/s	dB(A)
Air Impactool/Ball & Cam Impact Mechanism												
5980A1-EU	01337799	1-1/2" hole type	3,119-7,460	13,560	830	1,000	39.9	584	3/4"	25	65	106.1
5982A1-EU	01338516	2-1/2" hole type	5,424-13,560	27,120	830	850	54.5	645	3/4"	25	61	105.1
588A1-EU	01337880	2-1/2" hole type	16,270-33,900	67,800	355	550	97.5	646	1"	25	73	113.0

(1) Hole-type square drives for use with socket retaining rings (See description page 28).

ATEX Tools

When it comes to getting the toughest jobs done, professionals around the world choose Ingersoll Rand. With tools specifically designed to meet ATEX Zone 1 or Zone 2 requirements, we meet the most demanding safety regulations for working in dangerous atmospheres. From petrochemical refineries to plastic manufacturers, Ingersoll Rand offers safe and productive solutions to meet the demands of our customers.

3940/3942 Series Tools- Ex h IIA T4 Gb X
All other Tools- Ex h IIA T6 Gb X

Performance: Torque is what counts: the performance of our ATEX tools gives you the power you need to deal with challenging jobs, especially off-shore or in other adverse environments.

Reliability: Minimizing downtime: thanks to pressure fed-lubrication technology and the outstanding quality of Ingersoll Rand tools, our extended maintenance intervals give you more time to get the job done.



Durability: It doesn't get tougher than saltwater: in order to ensure corrosion resistance and improve overall durability, Ingersoll Rand selects only the finest materials and uses ultimately robust titanium parts.

Applications: From exploration and production to refining and processing of crude oil and gas products, Ingersoll Rand offers safe and productive solutions that meet the demands for zone 1 ATEX certified tools.

ATEX Tools

Ingersoll Rand has always offered products to be used in hazardous atmospheres. As well as the standard classic Impactools with housings in a special spark resistant alloy, investment in low static spark composite technology has made possible a new range of lightweight impacttools which are fully certified to classifications under the new European Directives 94/9/EC and 1999/92/EC – commonly known as the ATEX Directives.

These are the tool of choice for specialized applications within the petrochemical and mining industries, and in any production or processing areas where hazardous atmospheres can occur.

Safety: ATEX certification EX I M2 c IIB 95°C X and EX II 2 GD c IIB 95°C X allows these tools to be used in potentially explosive atmosphere in compliance with European Community Directives 94/9/EC and 1999/92/EC



Reliability: Ingersoll Rand Twin Hammer impact mechanism. Pressure-fed mechanism lubrication.

Control: feather-touch trigger allows precise delivery of power and speed.



Technical Specifications at 6.2 bar (90 psi) dynamic pressure at inlet

Model No.	Profile	in(1)	Recom. Nm	Max. Nm	1 min rpm	1 min bpm	kg	L mm	in (NPT)	mm	Max. I/s	dB(A)	m/s ² /K(2)
Air Drills													
7803RAKCEX	P	1/2" hole type	-	-	500	-	3.67	200	1/4"	10	27.0	94.0	> 2.5
7802RAKCEX	B	1/2" hole type	-	-	2,000	-	2.99	175	3/8"	10	26.0	94.0	2.8
Impact Wrench													
2131PEX	P	1/2" hole type	68-542	813	9,500	1,250	2.00	190	1/4"	10	11.0	93.7	8.3/1.1
Titanium Impact Wrench													
2925RBP1TiEX	P	3/4" hole type	407-1,288	2,169	5,200	1,050	5.44	225	3/8"	13	28.0	98.0	10.5/1.0
3940B2TiEX	B	1" hole type	678-2,237	3,729	6,000	800	9.6	341	1/2"	19	35	106.6	13.1/1.6
3942B2TiEX	B	1" hole type	1,356-2,644	4,407	5,000	850	10.5	361	1/2"	19	44	103.4	16.9/4.6
3955B2TiEX	B	1-1/2" hole type	2,170-5,290	6,780	2,750	700	15.7	423	1/2"	19	37	102.0	20.8/8.5

(1) Hole-type square drives for use with socket retaining rings (see description page 28).
(2) ISO28927 – 3-axis measurement: vibration level/measurement uncertainty.

Technical Specifications at 6.2 bar (90 psi) dynamic pressure at inlet

Model No.	CPN	Profile	in(1)	Recom. Nm	Max. Nm	1 min rpm	1 min bpm	kg	L mm	in (NPT)	mm	Max. I/s	dB(A)	m/s ² /K(2)
Air Impactool/Twin Hammer Mechanism														
2131PSP	45471687	P	1/2" hole type	68-542	813	9,500	1,250	2.00	190	1/4"	10	11.0	93.7	8.3/1.1
2145QiMAX-SP	47122585	P	3/4" hole type	271-1,220	1,830	6,300	1,150	3.35	217	3/8"	13	15.1	96.3	8.7/2.7
2155QiMAX-SP	47122619	P	1" hole type	271-1,220	1,830	6,300	1,150	3.36	225	3/8"	13	15.1	96.3	8.7/2.7
2934B2SP-EU	01337682	B	1" hole type	678-1,490	2,034	6,600	750	10.0	286	1/2"	19	22.0	97.9	18.8/3.7
2940B2SP-EU	01337583	B	1" hole type	1,360-2,170	2,710	5,000	850	8.40	311	1/2"	19	27.0	97.8	17.8/3.4

(1) Hole-type square drives for use with socket retaining rings (see description page 28).
(2) ISO28927 – 3-axis measurement: vibration level/measurement uncertainty.

Large Drills

These heavy duty drills are ideal for opening and closing large valves, or drilling large diameter holes between 14 mm – 76 mm.

22 Series:

- Ball bearing support for long life and efficient operation.
- Durable spur gearing.
- Governed motor regulates air to the motor to keep drill working at the peak of its power curve.
- Selection of speeds to match all applications.

33, 44 and 551 Series:

- Graduated roll throttle for excellent speed control.
- Ball bearing support for long life and efficient operation.
- Strong, lightweight heat-treated aluminum housing for strength without weight.



33SKA-EU

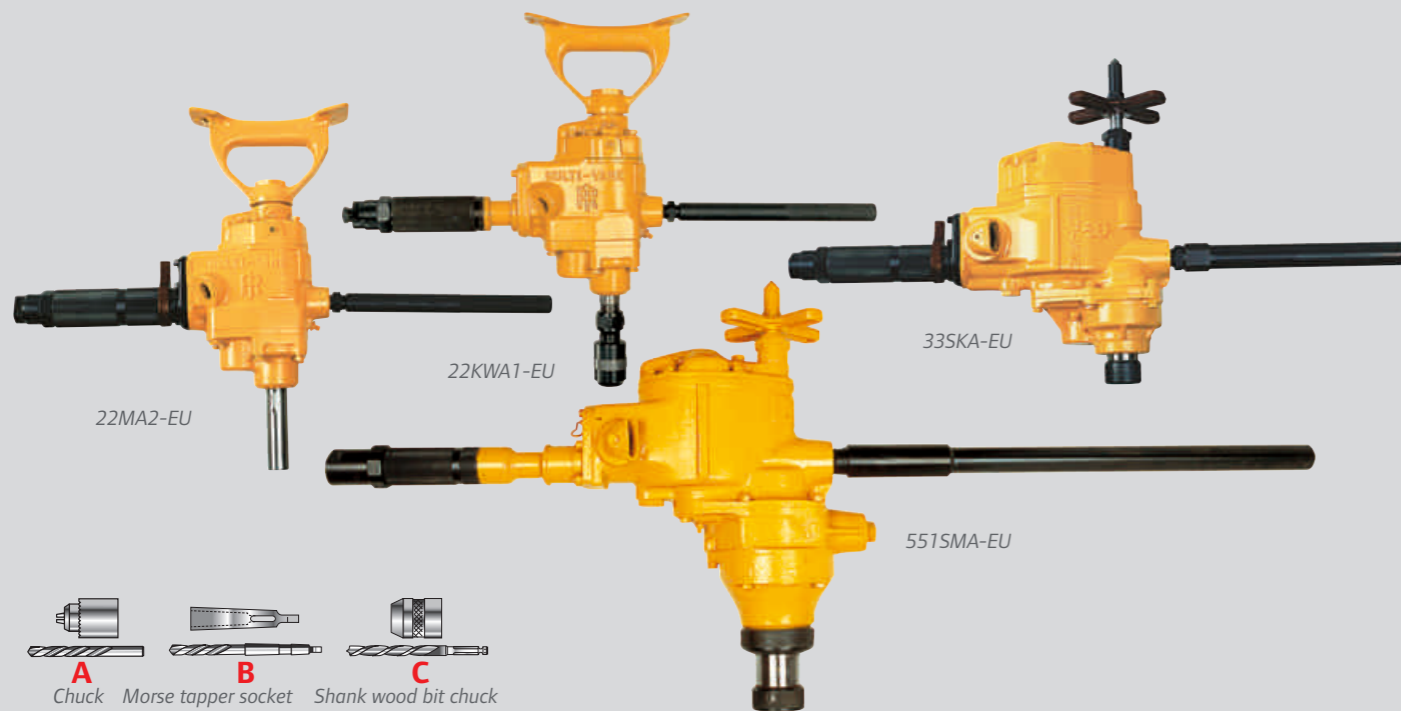

Technical Specifications at 6.2 bar (90 psi) dynamic pressure at inlet

Model No.	CPN	kWatt kWatt	1 min rpm	mm	mm	mm	kg	H mm	mm	in (BSP)	l/s	m/s ² /K ⁽¹⁾	
Large Drills													
22KA1-EU	01341809	1.30	725	A	0-1/2"	14	11	11	7.0	448	3/8"	13	26
22KWA1-EU	01340108	1.30	725	C	1/2" (2)	14	-	-	6.5	438	3/8"	13	26
22MA2-EU	01338292	1.30	350	B	No. 2	22	16	16	6.5	473	3/8"	13	26
33SKA-EU	01338623	2.20	300	B	No. 3	32	25	28	11.7	355	1/2"	19	40
33SMA-EU	01339449	2.20	185	B	No. 3	32	32	41	14.1	427	1/2"	19	40
44SMA-EU	01338953	2.68	155	B	No. 4	51	51	51	19.8	463	1/2"	19	48
551SMA-EU	01340959	4.66	120	B	No. 5	76	64	64	31.3	556	1"	25	75

(1) ISO28927 – 3-axis measurement: vibration level/measurement uncertainty.
(2) 1/2" stub taper, threaded.

Metric Impact Socket Sets

- Impact-grade toughness – designed for high-torque applications.
- Forged chrome-molybdenum steel for high strength durability.
- Electro-phosphate finish on 1/4 to 1" drive sizes – projects a sleek look and high visibility.
- Laser-etched socket size labelling for easy size identification.

Sockets sold individually. See next page



Model no.	Square drive and CPN	Description
Model no. SK2M12 	1/4" CPN: 81287336	Contains 6, 7, 8, 9, 10, 11, 12, 13 and 14 mm sockets, 50 and 100 mm extensions bars, 3/8"F to 1/4"M adapter.
Model no. SK3M10 	3/8" CPN: 81287344	Contains 9, 10, 11, 12, 13, 14, 15, 16, 17 and 19 mm sockets.
Model no. SK4M5L 	1/2" CPN: 81287369	Contains 5 deep sockets (17, 19, 21, 22 and 24 mm).
Model no. SK4M14 	1/2" CPN: 81287351	Contains 14 sockets (10, 11, 12, 13, 14, 15, 16, 17, 18, 19, 21, 22, 23 and 24 mm).
Model no. SK4M18 	1/2" CPN: 81287385	Contains 9 standard sockets (10, 11, 13, 14, 17, 19, 21, 22 and 24 mm), 4 deep sockets (13, 14, 21 and 24 mm), 3 deep/thin wall sockets (17, 19 and 21 mm), 125 mm extension bar and 1/2" square drive power joint.
Model no. SK4M7U 	1/2" CPN: 80171093	Contains 7 sockets, pre-fitted on power joints to facilitate works with very limited accessibility (13, 14, 15, 17, 19, 21 and 22 mm)
Model no. SK6M6L 	3/4" CPN: 81287401	Contains 6 extended sockets (24, 27, 30, 32, 33 and 36 mm).
Model no. SK8M4L 	1" CPN: 81287419	Contains 4 extended sockets (27, 30, 32 and 33 mm).

Retaining Rings

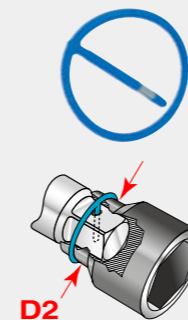

Part no.	CPN	Qty.	Internal Ø	Material
RR10001	49825524	10	15.0 mm	Plastic
RR10002	49825532	10	17.0 mm	Plastic
RR10003	49825540	10	19.0 mm	Plastic
RR10004	49825557	10	20.0 mm	Plastic
RR10005	49825565	10	22.0 mm	Plastic
RR10006	49825573	10	24.0 mm	Plastic
RR10007	49825581	10	24.0 mm	Plastic
RR10008	49825599	10	29.0 mm	Plastic
RR10005S	03816055	1	32.0 mm	Plastic + Steel insert
RR10009	49825607	10	33.0 mm	Plastic
RR10032S	03809258	1	36.5 mm	Plastic + Steel insert

Part no.	CPN	Qty.	Internal Ø	Material
RR10010	80206477	10	37.0 mm	Plastic
RR10034S	03809266	1	41.5 mm	Plastic + Steel insert
RR10008S	03809274	1	44.5 mm	Plastic + Steel insert
RR10010S	03809282	1	49.0 mm	Plastic + Steel insert
RR10015S	03809290	1	54-57 mm	Plastic + Steel insert
RR10017S	03816063	1	63.5 mm	Plastic + Steel insert
RR10019S	03809308IRI	1	67.0 mm	Plastic + Steel insert
RR10020S	03809316	1	76.0 mm	Plastic + Steel insert
RR10025S	03809324	1	86.0 mm	Plastic + Steel insert
RR10030S	03809332	1	98.5 mm	Plastic + Steel insert
RR10035S	03809340	1	111.0 mm	Plastic + Steel insert

Because of the elasticity of the material, the diameter at the female square drive of the socket (D2) can be slightly larger than the ring.
Note: The retainer rings must have a tight fit on the socket.

Surface Preparation Tools.

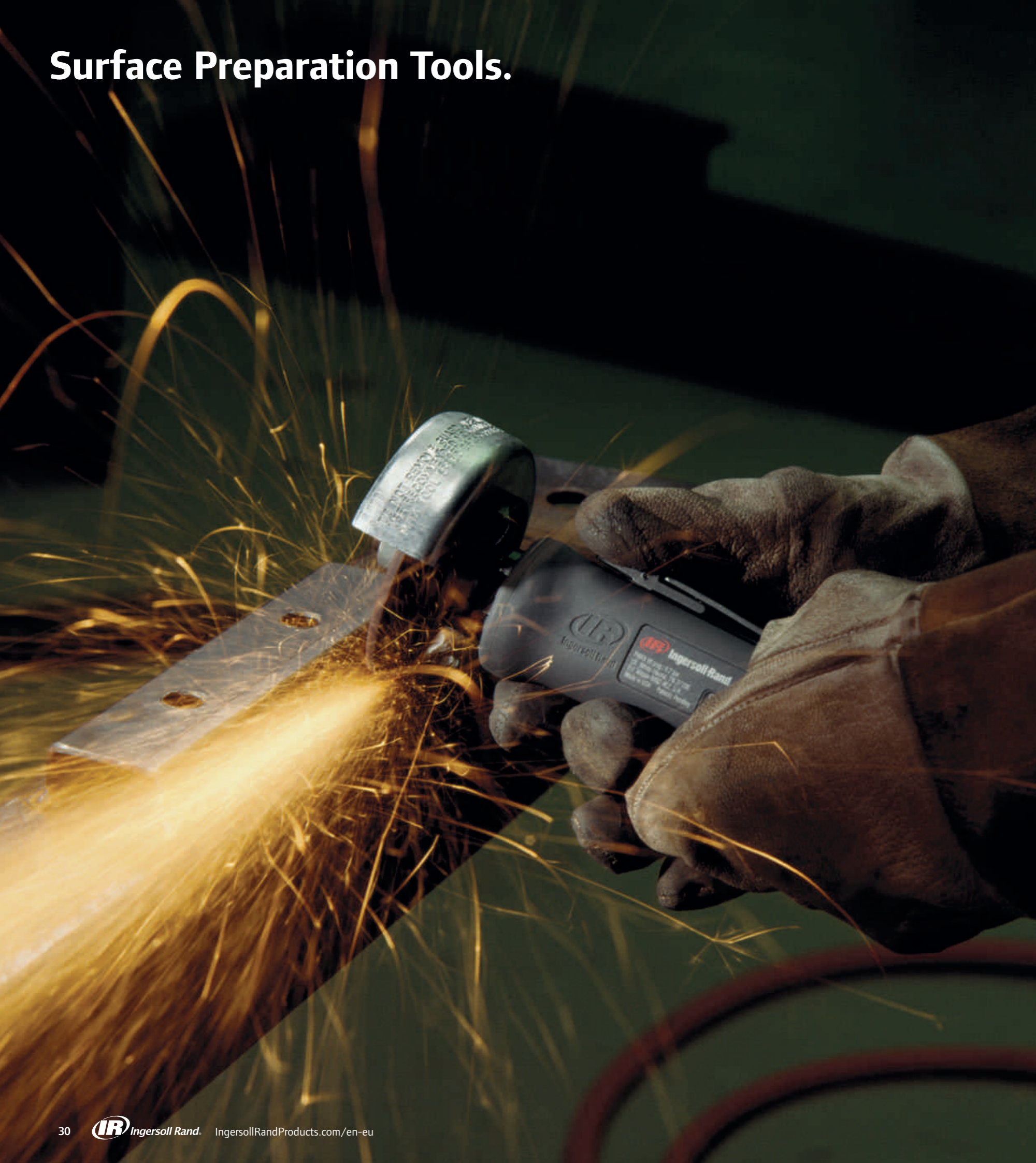

Pneumatic Grinding & Finishing

- 32 | Selection Chart
- 33 | Air Grinders and Sanders
- 42 | Special Air Grinders/Sanders
- 44 | Air Random Orbital Sanders
- 45 | Accessories

Advancements in manufacturing and production continue to transform the nature of industrial finishing. In many segments, increases in precision and reductions in waste are changing overall demands. New materials require different tool speeds and attachments; parts and components must match surrounding surfaces with greater accuracy. For more than 100 years, Ingersoll Rand has helped transform the way the industry works. Our designs reflect emerging trends in finishing tool use, changing technology, and new materials. Whatever the application, Ingersoll Rand finishing tools bring out the best in your operators' skills, and contribute to the ultimate quality of your products and processes.

Wheel Types and Collets

Straight Grinders



Type 1 wheels

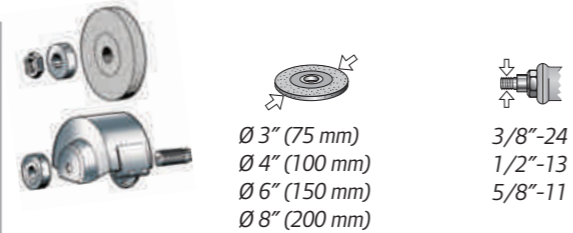
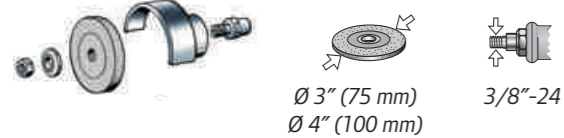

Angle Grinders



Type 27 and 28 depressed centre flat wheels

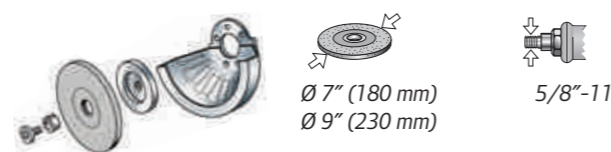
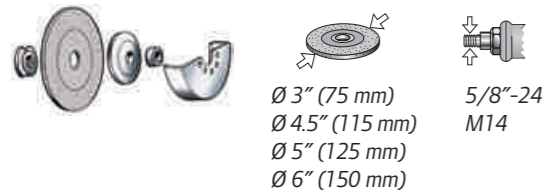

Cone and Plug Wheel Grinders



Type 16, 17, 18, 18R, and 19 cone and plug wheels

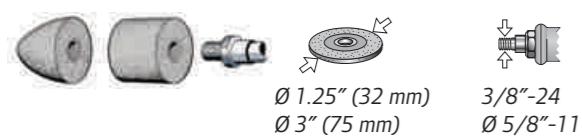

Collet Type Grinders



Mounted wheels and high speed steel or carbide burrs

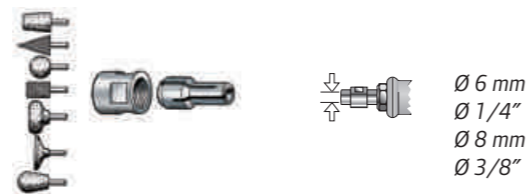

Angle Grinders



Type 16, 17, 18, 18R, and 19 cone and plug wheels



Mounted wheels and high speed steel or carbide burrs

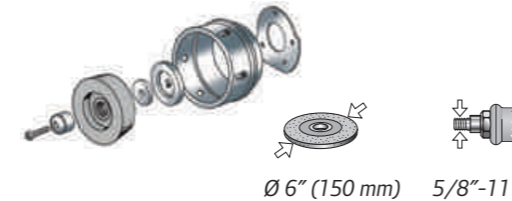

MAX-Series Grinders

Our MAX-series air die grinders and air angle grinders are economical, long-life tools. They are compact, lightweight, easy to handle and include all bearing construction for increased reliability.

- 0.3 kW motor – Lube-free design eliminates contamination of the work environment.
- Enhanced grip design and low-profile throttle lever provide for extended run time without fatigue.
- Piped away exhaust kit included.

Accessories:

- 301-700 (CPN 04552600): 1/4" collet.
- 301-700B (CPN 80128952): 6 mm collet.
- 301-700C (CPN 80102346): 1/8" collet.

- 0.88 hp and 12 000 rpm motor.
- Internal governor maximizes speed under load, increasing your rate of material removal.
- Low weight and enhanced grip design enables extended usage without fatigue.



★★★ Super-duty tools
★★ Heavy-duty tools
★ Maintenance-duty tools

Technical Specifications at 6.2 bar (90 psi) dynamic pressure at inlet

Model No.	CPN	kWatt	1 min rpm	mm	mm	kg	mm	in	mm	Max. l/s	dB(A)	m/s ² /K ⁽¹⁾	
Die Grinders													
5102MAX	48488357	0.30	20,000	6 mm + 1/4"	-	0.64	180	1/4" NPT	10	11.8	84.1	3.3/1.1	
5108MAX	48488340	0.30	25,000	6 mm + 1/4"	-	0.46	172	1/4" NPT	10	11.8	83.3	1.8/0.8	
Angle Grinders													
3445MAX-M	45664240	0.66	12,000	-	115	M14	1.53	245	1/4" NPT	10	19.3	79.6	6.4/2.0
345MAX-M	45664257	0.66	12,000	-	125	M14	1.56	245	1/4" NPT	10	19.3	79.6	7.9/0.7

(1) ISO28927 – 3-axis measurement: vibration level/measurement uncertainty.

VT 26 & VT 45 Turbine Grinders

Whether in shipyards, foundries or forges: Ingersoll Rand's brand new family of turbine grinders takes the edge off that daily grind. Its sheer power and extreme durability let you get more work done in less time — even under heavy-duty conditions. And with oil change and disc replacement being a snap, you can depend on the VT26 and VT45 turbine grinders to be ready when you are.



★★★★ Super-duty tools
★★★ Heavy-duty tools
★★ Maintenance-duty tools

Technical Specifications at 6.2 bar (90 psi) dynamic pressure at inlet

Model No.	kWatt	1 min rpm	mm	mm	kg	mm	in	mm	Max. l/s	dB(A)	m/s ² /K ⁽¹⁾	
Turbine Grinders												
VT26A120SP955	2.60	12,000	-	125	M14	2.20	299	G 1/2"	13	37.5	86	3.7
VT26A085SP98	2.60	8,500	-	180	M14	2.80	313	G 1/2"	13	37.5	86	4.0
VT45A085SP98	4.50	8,500	-	180	M14	4.00	324	G 1/2"	19	55.0	87	<2.5
VT45A066SP995	4.50	6,600	-	230	M14	4.30	324	G 1/2"	19	55.0	84	<2.5

(1) ISO28927 – 3-axis measurement: vibration level/measurement uncertainty.

G Series Die Grinders

From the compact 0.3 kW (0.4 hp) G1 Series to the powerful 1.0 kW (1.35 hp) G3 Series, these grinders are made for any grinding, cutting, and material removal needs.

G1 Series:

For light material removal, cleaning rough castings and welds, deburring parts.

- 0.3 kW (0.4 hp) motor.
- Easily interchangeable front/rear exhaust.
- Piped-away exhaust as standard.

G3 Series:

For heavy material removal with burrs, grinding wheels, and coated abrasives. Internal contamination-free air controller helps maintain tool speed regardless of the load.

- High torque 1 kW (1.35 hp) air motor.
- Internal motor governor maximizes speed under load, increasing your rate of material removal.
- Auto balancing system and anti-vibration dead handle on G3 "AV" models significantly reduces vibrations and increases life of grinding wheels.
- Piped-away exhaust as standard.



Auto balancing system on G3 Series

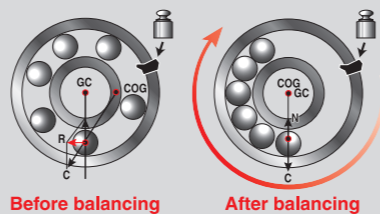

Technical Specifications at 6.2 bar (90 psi) dynamic pressure at inlet

Model No.	CPN	kWatt kWatt	1 min rpm	mm	kg	L mm	in (NPT)	mm	Max. l/s	dB(A) (1)	m/s ² /K ⁽²⁾
Straight Die Grinders											
G1H200PG4M	80155245	0.30	20,000	6mm	0.41	156	1/4"	8	9.0	78.5	2.9/1.7
G1H250PG4M	80155286		25,000	6mm	0.41	156	1/4"	8	9.4	79.2	2.5/1.4
G1H350PG4M	80155310		35,000	6mm	0.41	156	1/4"	8	11.8	81.1	< 2.5
G3H150PG4M	80224231	1.00	15,000	6mm	1.05	230	3/8"	13	15.6	83.5	3.7/2.6
G3H180PG4M	80223787		18,000	6mm	1.05	230	3/8"	13	26.0	83.5	< 2.5
Straight Extended Die Grinders											
G1X200PG4M	80155336	0.30	20,000	6 mm	0.59	232	1/4"	8	11.8	77.9	< 2.5
G1X250PG4M	80155351		25,000	6 mm	0.59	232	1/4"	8	11.8	80.0	< 2.5
G1X350PG4M	80155377		35,000	6 mm	0.59	232	1/4"	8	11.8	81.9	< 2.5
G3X150PG4M	80155765	1.00	15,000	6 mm	1.70	359	3/8"	13	15.6	87.9	3.6/0.8
G3X180PG4M	50155732		18,000	6 mm	1.70	359	3/8"	13	26.0	86.4	< 2.5

(1) Sound pressure without pipe away exhaust (up to 6 dB(A) less with piped away exhaust).

(2) ISO28927 – 3-axis measurement: vibration level/measurement uncertainty.

Technical Specifications at 6.2 bar (90 psi) dynamic pressure at inlet

Model No.	CPN	kWatt kWatt	1 min rpm	mm	kg	L mm	in (NPT)	mm	Max. l/s	dB(A) (1)	m/s ² /K ⁽²⁾
Angle Die Grinders											
G1A200PG4M	80155211	0.30	20,000	6 mm	0.50	152	1/4"	8	11.8	80.6	5.6/1.1
G3A120PG4M	80177462	1.00	12,000	6 mm	1.90	241	3/8"	13	26.0	84.7	5.5/0.9
G1A120PG4M	80155187	0.30	12,000	6 mm	0.50	152	1/4"	10	8.96	79.6	3.4/0.9

(1) Sound pressure without pipe away exhaust (up to 6 dB(A) less with piped away exhaust).

(2) ISO28927 – 3-axis measurement: vibration level/measurement uncertainty.

M Series Die Grinders

Super Duty Grinder Suited for heavier-duty grinding, cutting, cleaning, and polishing applications.

Engineered and built with Ingersoll Rand reliability and durability, the M Series has the features operators want most.

M2 Series:

For heavier-duty applications in grinding, cutting, cleaning, and polishing.

- Powerful 0.75 kW (1 hp) lube-free air motor.
- Internal motor governor maintains grinder speed and manages air flow for efficient energy use.

- Spindle lock on angle models, allows faster, easier accessory changes.
- Piped-away exhaust as standard.



Technical Specifications at 6.2 bar (90 psi) dynamic pressure at inlet

Model No.	CPN	kWatt kWatt	1 min rpm	mm	kg	L mm	in (NPT)	mm	Max. l/s	dB(A) (1)	m/s ² /K ⁽²⁾
Straight Die Grinders											
M2H180RG4	48421580	0.75	18,000	6 mm + 1/4"	0.77	213	3/8"	10	19.8	84.7	4.2/1.6
M2H200RG4	48421572		20,000	6 mm + 1/4"	0.77	213	3/8"	10	19.8	84.9	4.4/1.1
M2H250RG4	48393003		25,000	6 mm + 1/4"	0.77	213	3/8"	10	19.8	88.2	< 2.5
Straight Extended Die Grinders											
M2X075RG4	48405294	0.75	7,500	6 mm + 1/4"	1.35	304	3/8"	10	19.8	88.0	< 2.5
M2X180RG4	48418396		18,000	6 mm + 1/4"	1.22	332	3/8"	10	19.8	88.8	2.8/0.9
M2X200RG4	48421655		20,000	6 mm + 1/4"	1.22	332	3/8"	10	19.8	84.9	< 2.5
M2X250RG4	48421663		25,000	6 mm + 1/4"	1.22	332	3/8"	10	19.8	88.2	< 2.5

(1) Sound pressure without pipe away exhaust (up to 6 dB(A) less with piped away exhaust).

(2) ISO28927 – 3-axis measurement: vibration level/measurement uncertainty.

Technical Specifications at 6.2 bar (90 psi) dynamic pressure at inlet

Model No.	CPN	kWatt kWatt	1 min rpm	mm	kg	L mm	in (NPT)	mm	Max. l/s	dB(A) (1)	m/s ² /K ⁽²⁾
Angle Die Grinders											
M2A120RG4	48421648	0.75	12,000	6 mm + 1/4"	1.62	227	3/8"	10	19.8	87.1	< 2.5
M2A180RG4	48421697		18,000	6 mm + 1/4"	1.62	227	3/8"	10	19.8	88.8	3.1/1.0

(1) Sound pressure without pipe away exhaust (up to 6 dB(A) less with piped away exhaust).

(2) ISO28927 – 3-axis measurement: vibration level/measurement uncertainty.

Erickson Collets for G1 Series

Model No.	CPN	Size
DG110-700-G2	03641743	3.2 mm
DG110-700-6MM	04261053	6 mm
DG110-700-G4	03641602	6.35 mm

Erickson Collets for M2 and G3 Series

Model No.	CPN	Size
G160HD-700-6MM	04261061	6 mm
G160HD-700-1/4	03493962	6.35 mm
DG121HD-700-M8	03641321	8 mm
DG120HD-700-G6	03641313	9.52 mm

G and M Series Grinders



Technical Specifications at 6.2 bar (90 psi) dynamic pressure at inlet

Model No.	CPN	kWatt	1 min rpm	mm	mm	kg	mm	in (NPT)	mm	Max. l/s	dB(A) (1)	m/s ² /K(2)
Angle Grinders												
G1A200PP63	80155419	0.30	20,000	75	3/8"-24	0.59	152	1/4"	8	11.8	79.9	16.8/6.2
M2A090RP95	48421622	0.75	9,000	125	M14	1.62	236	3/8"	10	19.8	87.7	4.6/1.6
M2A120RP945	48391981		12,000	115	M14	1.71	236	3/8"	10	19.8	87.0	5.1/1.5
M2A120RP95	48421606	1.0	12,000	125	M14	1.77	236	3/8"	10	19.8	87.0	5.0/1.6
G3L086PP95 (3)	80232408		8,600	125	M14	2.32	330	3/8"	13	26.0	84.0	5.0/1.6
G3A100PP96AV	80217052	1.0	10,000	150	M14	2.32	245	3/8"	13	26.0	86.1	4.8/1.9
G3A120PP945AV	80217037		12,000	115	M14	2.18	245	3/8"	13	15.6	88.7	4.8/1.5
G3A120PP95AV	80217045	12,000	125	M14	2.09	245	3/8"	13	26.0	88.7	5.0/1.9	
Straight Grinders												
G1H250PH63	80155443	0.30	25,000	75	3/8"-24	0.57	156	1/4"	8	9.4	81.1	10.7/3.3
M2X180RH63	48421580	0.75	18,000	75	3/8"-24	1.48	339	3/8"	10	19.8	85.3	< 2.5
G3X150PH64	80155799	1.0	15,000	100	3/8"-24	2.04	359	3/8"	13	15.6	84.5	2.5/0.8
G3X180PH63	80155781		18,000	75	3/8"-24	2.04	359	3/8"	13	26.0	88.8	2.8/0.9

(1) Sound pressure without pipe away exhaust (up to 6 dB(A) less with piped away exhaust).
(2) ISO28927 - 3-axis measurement: vibration level/measurement uncertainty.
(3) Extended angle grinder.

G and M Series Sanders



Sanding Pads for G and M Series

Model No	CPN	Description	Size
02A-MEDPD	80199177	For G1 Series	Ø 50 mm (2")
03A-MEDPD	80198963		Ø 75 mm (3")
77A-AM825-5	03675477	For M2 and G3 Series (medium)	Ø 125 mm (5")
77A-AM825-7	03675469		Ø 180 mm (7")
77A-AM825-9	03675451	For M2 and G3 Series (firm)	Ø 230 mm (9")

Technical Specifications at 6.2 bar (90 psi) dynamic pressure at inlet

Model No.	CPN	kWatt	1 min rpm	mm	kg	mm	in (NPT)	mm	Max. l/s	dB(A) (1)	m/s ² /K(2)			
Sanders														
G1A120PS4	80155468	0.30	12,000	Option (see the table above)	1/4"-20	0.50	152	1/4"	8	9.0	80.6	3.0/1.0		
G1A200PS4	80155534		20,000										11.8	82.4
M2L025RS9	48421788	0.75	2,500	M14	1.90	318	3/8"	10	19.8	87.0	4.0/1.4			
M2L040RS9	48421796		4,000									19.8	88.8	2.8/1.8
M2L055RS9	48421812		5,500									19.8	88.8	3.7/1.1
G3L086PS10	80223803	1.0	8,600	M14	1.90	318	3/8"	10	19.8	88.8	3.7/1.1			
					5/8"-11	1.93	330	3/8"	13	15.6	82.0	< 2.5		

(1) Sound pressure without pipe away exhaust (up to 6 dB(A) less with piped away exhaust).
(2) ISO28927 - 3-axis measurement: vibration level/measurement uncertainty.

G Series Belt Sanders

Technical Specifications at 6.2 bar (90 psi) dynamic pressure at inlet

Model No.	CPN	kWatt	1 min rpm	mm	kg	mm	in (NPT)	mm	Max. l/s	dB(A) (1)	m/s ² /K(2)
Belt Sanders											
G1A120PS418	80155484	0.30	12,000	457 x 6.35	0.54	356	1/4"	8	9.0	82.4	< 2.5
G1A120PS812	80155500		12,000	305 x 12.7	0.54	273	1/4"	8	9.0	82.4	< 2.5
G1A200PS812	80155559		20,000	305 x 12.7	0.54	273	1/4"	8	11.8	83.6	2.6/0.7

(1) Sound pressure without pipe away exhaust (up to 6 dB(A) less with piped away exhaust).
(2) ISO28927 - 3-axis measurement: vibration level/measurement uncertainty.

Sanding Belts 3/8"-24 female thread

Model No.	CPN	Dimensions	Grit
LG1-SB812-60-10	04025649	12.7 x 305 mm (1/2" x 12")	60
LG1-SB812-80-10	04025656		80
LG1-SB812-100-10	04025664		100
LG1-SB418-60-10	04279832	6.35 x 457 mm (1/4" x 18")	60
LG1-SB418-80-10	04279840		80
LG1-SB418-100-10	04279857		100



See also our PBA416 high precision belt sander page 42

Pro Series Grinders/Sanders

Pro Series grinders incorporate a patented motor controller which is designed to increase productivity while enhancing operator safety. Adjustable side handles, an ergonomic main handle, and self-locking throttle all help to reduce operator fatigue.

Reliability:

- Solid steel motor and arbor housing provide maximum durability.
- Built-in mist lubricator automatically oils motor when throttle is activated.

Efficiency:

- Heavy-duty, double-row ball bearings assure long life and smooth operation.
- Auto balancing system on angle and vertical models – reduces vibration and increases abrasives lifetime.



Auto balancing system on Pro-Series angle and vertical models

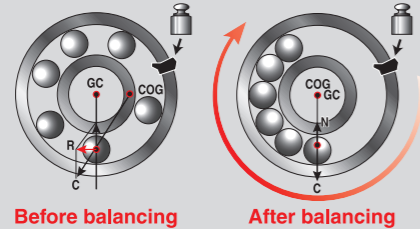

Pro-Series motor controller prevents over-speeding and manages air flow for efficient energy use



Pro-Series Straight Grinders/Collet

Erickson Collet



Technical Specifications at 6.2 bar (90 psi) dynamic pressure at inlet

Model No.	CPN	kWatt kWatt	1 min rpm	mm	kg	L mm	in (NPT)	mm	Max. l/s	dB(A)	m/s ² /K ⁽¹⁾
Straight Grinders - Erickson Collet											
61H150G4-EU	01339316	1.00	15,000	6 mm	1.9	394	3/8"	13	18.9	89.8	< 2.5
61H120G4-EU	01338391	0.93	12,000	6 mm	1.9	394	3/8"	13	17.5	86.6	< 2.5

(1) ISO28927 – 3-axis measurement: vibration level/measurement uncertainty.

Erickson Collets for 61H Series



Model No.	CPN	Size
G160HD-700-6MM	04261061	6 mm
G160HD-700-1/4	03493962	1/4"
DG121HD-700-M8	03641321	8 mm
DG120HD-700-G6	03641313	3/8"

Pro-Series Angle Grinders

Type 27 and 28 wheels



Technical Specifications at 6.2 bar (90 psi) dynamic pressure at inlet

Model No.	CPN	kWatt kWatt	1 min rpm	mm	kg	L mm	in (NPT)	mm	Max. l/s	dB(A)	m/s ² /K ⁽¹⁾
Angle Grinders											
77A60P107M-EU	01338300	1.12	6,000	180	4.1	447	3/8"	13	18.4	85.9	< 2.5
77A75P107M-EU	01338771	1.12	7,500	180	4.2	447	3/8"	13	18.4	85.9	2.6/0.8
77A60P109M-EU	01338201	1.12	6,000	230	4.2	447	3/8"	13	18.4	104.7	2.4/0.8

(1) ISO28927 – 3-axis measurement: vibration level/measurement uncertainty.

Pro-Series Straight Grinders

Type 1 wheel

Type 16, 17, 18, 18R and 19 wheels



Technical Specifications at 6.2 bar (90 psi) dynamic pressure at inlet

Model No.	CPN	kWatt kWatt	1 min rpm	mm	kg	L mm	in (NPT)	mm	Max. l/s	dB(A)	m/s ² /K ⁽¹⁾
Straight Grinders – Type 1 Wheels											
61H120H63-EU	01339290	0.93	12,000	75	2.16	400	3/8"	13	18.9	86.6	< 2.5
61H150H63	01238567	1.00	15,000	75	2.16	400	3/8"	13	17.5	86.4	< 2.5
77H120H84-EU	01339308	1.12	12,000	100	2.95	438	3/8"	13	18.4	85.4	2.8/1.2
88HL60H106-EU	01339407	1.50	6,000	150	5.14	508	1/2"	19	28.8	79.4	< 2.5
99HL60H106-EU	01339373	2.25	6,000	150	6.14	521	1/2"	19	39.7	85.8	< 2.5
Straight Grinders – Type 16, 17, 18, 18R and 19 Wheels											
61H120L6-EU	01340454	0.93	12,000	—	1.93	375	3/8"	13	17.5	86.6	< 2.5
61H150L6-EU	01340561	1.00	15,000	—	1.93	375	3/8"	13	18.9	89.8	< 2.5
77H90L10-EU	01339118	1.12	9,000	—	2.73	418	3/8"	13	17.5	80.9	< 2.5
77H120L10-EU	01340280	1.12	12,000	—	2.73	418	3/8"	13	18.4	85.4	4.2/3.5

(1) ISO28927 – 3-axis measurement: vibration level/measurement uncertainty.

Pro-Series Vertical Grinders



Technical Specifications at 6.2 bar (90 psi) dynamic pressure at inlet

Model No.	CPN	kWatt	1 min rpm	mm	kg	L mm	in (NPT)	mm	Max. l/s	dB(A)	m/s ² /K ⁽¹⁾	
Vertical Grinders – Type 27 and 28 Wheels												
88V60P107M-EU	01337948	1.56	6,000	180	5/8"-11	4.0	154	1/2"	19	28.8	89.2	3.1/0.9
88V85P107M-EU	01337658	1.64	8,500	180	5/8"-11	4.0	154	1/2"	19	31.2	86.9	4.1/1.3
99V60P107M-EU	01338425	2.25	6,000	180	5/8"-11	5.1	174	1/2"	19	39.7	84.4	2.8/0.9
88V60P109M-EU	01337716	1.56	6,000	230	5/8"-11	4.2	154	1/2"	19	28.8	89.2	3.6/1.1
99V60P109M-EU	01337575	2.25	6,000	230	5/8"-11	5.1	174	1/2"	19	39.7	85.5	3.4/1.1
Vertical Grinders – Type 6 and 11 Cup Wheels												
88V60S106M-EU	01340058	1.56	6,000	150	5/8"-11	3.8	154	1/2"	19	28.8	89.2	<2.5
99V60S106M-EU	01339068	2.25	6,000	150	5/8"-11	4.8	174	1/2"	19	39.7	85.4	<2.5

(1) ISO28927 – 3-axis measurement: vibration level/measurement uncertainty.



Accessories

Model No.	CPN	Description
88V60-K184	03643962	Piped-away exhaust system for 88V models
99V60-K184	03625589	Piped-away exhaust system for 99V models

Pro-Series Sanders and Polishers



Technical Specifications at 6.2 bar (90 psi) dynamic pressure at inlet

Model No.	CPN	kWatt	1 min rpm	mm	kg	L mm	H mm	in (NPT)	mm	Max. l/s	dB(A)	m/s ² /K ⁽¹⁾	
Straight Sanders													
77H30B106-EU	01339670	1.12	3,000	150	5/8"-11	3.32	449	—	3/8"	13	17.5	85.2	5.9/2.1
77H50B106-EU	01340397	1.12	5,000	150	5/8"-11	3.32	449	—	3/8"	13	18.4	94.4	7.8/2.7
Angle Sanders													
77A25F107-EU	01340835	1.12	2,500	180	5/8"-11	3.81	446	—	3/8"	13	17.5	89.2	<2.5
77A60W107-EU	01340165	1.12	6,000	180	5/8"-11	3.55	446	—	3/8"	13	18.4	85.9	<2.5
77A45W109-EU	01339720	1.12	4,500	230	5/8"-11	3.55	446	—	3/8"	13	17.5	83.3	<2.5
Vertical Sanders													
7P24L-EU	01339712	0.6	2,400	180	5/8"-11	1.47	—	162	1/4"	10	10.4	82.7	<2.5
7S48L-EU	01340348	0.6	4,800	180	5/8"-11	1.47	—	162	1/4"	10	10.4	81.4	<2.5
7S60L-EU	01338318	0.6	6,000	180	5/8"-11	1.47	—	162	1/4"	10	10.4	82.0	<2.5
88S60W107-EU	01338037	1.50	6,000	180	5/8"-11	3.24	—	152	1/2"	19	28.8	80.2	<2.5
88S45W109-EU	01339126	1.35	4,500	230	5/8"-11	3.24	—	152	1/2"	19	23.6	77.6	<2.5

(1) ISO28927 – 3-axis measurement: vibration level/measurement uncertainty.

Sanding Pads

Model No.	CPN	Description	Size
77A-AM825-5	03675477	Medium sanding pad (for all models)	Ø 125 mm (5")
77A-AM825-7	03675469	Medium sanding pad (for all models)	Ø 180 mm (7")
77A-AM825-9	03675451	Firm sanding pad (for all models)	Ø 230 mm (9")
P500-850	03379542	Wool polishing bonnet (for 7 and 77 models)	Ø 180 mm (7")



Pencil Grinders

- ★★★ Super-duty tools
- ★★ Heavy-duty tools
- ★ Maintenance-duty tools



Excellent for intricate grinding applications, including mold finishing.

- Comfortable design enables precise control.
- Delivered with 1/8" collet insert, 6 mm air hose (length 1.80 m) and 0.45 m rear exhaust over-hose.
- DG600G2K-EU kit includes six additional carbide burrs in a moulded carrying case.

Accessories

Model No	CPN	Description
47568-2	04136164	Collet Ø 3 mm
47568-3	04136172	Collet Ø 3/32"

Engraving Pen

- ★★★ Super-duty tools
- ★★ Heavy-duty tools
- ★ Maintenance-duty tools



Ingersoll Rand engraving pen is designed to meet your industrial engraving needs. Variable zoom throttle permits a wide range of engraving possibilities from hard alloys to brittle ceramics.

- Moulded carrying case with EP50 engraving pen, air hose and 3 assorted styli (fine, medium and coarse point).
- Knurled zoom throttle – Variable speed.

Accessories

Model No.	CPN	Description
EP50-514	03800760	Stylus grinding collet
EP50-515	03800778	Fine point stylus (black)
EP50-516	03800786	Medium point stylus (grey)
EP50-517	03800794	Coarse point stylus (green)



Multi-tools

- ★★★ Super-duty tools
- ★★ Heavy-duty tools
- ★ Maintenance-duty tools

Compact and versatile tools for high precision work.

- Usable with carbide burr, grinding disc or sanding belt.
- 360° rotative head on PBA model.
- POLA15000 delivered with collet (without pad).



Rubber pad for self-adhesive discs

Model No.	CPN	Description
117155	04373478	Ø 20 mm
116920	04373486	Rubber pad for self-adhesive discs, Ø 30 mm
116930	04373494	Ø 46 mm
116940	04371464	Ø 76 mm
002300	04373031	Grit 36
002301	04373049	Grit 40
002302	04373056	Grit 50
002303	04373064	Grit 60
002304	04373072	Grit 80
002305	04373080	Grit 100
122629	04363503	6 mm collet

Technical Specifications at 6.2 bar (90 psi) dynamic pressure at inlet

Model No.	CPN	kWatt	1 min rpm	1 min bpm	mm	kg	mm	in	mm	Max. l/s	dB(A)	m/s ² /K ⁽¹⁾
EP50K-EU	01339506	—	—	18,750	—	0.14	137	1/8" NPT	6	—	75.5	—
POLA15000	04368379	0.22	15,000	—	6 mm	0.65	—	1/4" BSP	10	6.5	NA	NA
PBA416	04368387	0.22	14,800	—	475 x 15	1.05	—	1/4" BSP	10	6.6	NA	NA

(1) ISO28927 – 3-axis measurement: vibration level/measurement uncertainty.

- ★★★ Super-duty tools
- ★★ Heavy-duty tools
- ★ Maintenance-duty tools

Revolution Series Die Grinders

With an ergonomic body and straight, angled and extended configurations, the Revolution Series Die Grinders are built to be powerful, versatile and comfortable to use.

ACCESS:

The Revolution Series come in straight, angled and extended configurations for use in a variety of jobs so you can reach even the toughest of places.

COMFORT:

The Revolution Series Die Grinder has composite housing that is lightweight, contoured for comfort, and protects operators from temperature fluctuations.



Technical Specifications

MODEL	kWatt	1 min rpm	in	kg	mm	Max. l/min	in (NPT)	mm	m/s ² /K ⁽¹⁾
312AC4A	0.3	12000	Collet- 1/4 in.	0.55	170	908	1/4	10	3.4/1.0
314AC4A	0.25	14000	Collet- 1/4 in.	0.55	170	851	1/4	10	3.2/0.7
320AC4A	0.3	20000	Collet- 1/4 in.	0.55	170	908	1/4	10	2.5/1.1
325SC4A	0.3	25000	Collet- 1/4 in.	0.43	166	908	1/4	10	2.6/1.1
325XC4A	0.3	25000	Collet- 1/4 in.	0.62	244	936	1/4	10	< 2.5
330SC4A	0.25	30000	Collet- 1/4 in.	0.43	166	851	1/4	10	3.6/1.9
330XC4A	0.25	30000	Collet- 1/4 in.	0.62	244	851	1/4	10	< 2.5
335SC4A	0.28	35000	Collet- 1/4 in.	0.43	166	851	1/4	10	3.0/0.8

Pro Series Grinders/Orbital Sanders

The 41-Series vacuum-ready sanders have established new standards for ergonomic design, power and speed in sanding applications.

All models deliver unsurpassed reliability, with moisture-resistant composite rotors, fully machined counterweights and large counterweight bearings.

Performance: powerful 0.15 kW motor produces the best speed under load for a swirl-free finish. Fully machined counterweight significantly reduces vibration.

Comfort: lightweight composite housing makes this sander the lightest tool in its class. Three sizes of interchangeable rubber grip rings available to fit all hand sizes.



Technical Specifications at 6.2 bar (90 psi) dynamic pressure at inlet

Model No.	CPN	mm	mm	mm	kWatt	1 min rpm	kg	H mm	in (NPT)	mm	Max l/s	dB(A)	m/s ² /K ⁽¹⁾
Vacuum-Ready Sanders													
4151-HL	01371624	150 ⁽¹⁾	5.0	5/16"-24	0.15	12,000	0.86	109	1/4"	8	7.5	81.6	7.5/1.6
4151-HL-2	22041198	150 ⁽¹⁾	5.0	5/16"-24	0.15	12,000	1.12	109	1/4"	8	7.5	81.6	6.2/1.0
4152-HL	80134356	150 ⁽¹⁾	2.5	5/16"-24	0.15	12,000	0.86	109	1/4"	8	7.5	81.6	8.2/1.7
4152-HL-SR	16674301	75 ⁽¹⁾	2.5	5/16"-24	0.15	12,000	0.84	109	1/4"	8	7.5	81.6	4.7/1.3

(1) Hook and loop backing pad.

(2) ISO28927 – 3-axis measurement: vibration level/measurement uncertainty.



Rubber grips rings – Replacement sanding pads

Model No.	CPN	Description
49801	04248571	Rubber grip, small hand size (not for 4151HI-2)
49798	04248555	Rubber grip, medium hand size (not for 4151HI-2)
49799	04248563	Rubber grip, large hand size (not for 4151HI-2)
49840	04252938	Rubber grips (3 pieces: small, medium & large)
010056	15969223	Hook & loop pad, Ø 75 mm
49693	04214797	Hook & loop pad, Ø 125 mm
49835	04250171	Hook & loop pad, Ø 150 mm
49096-1	04320578	Vinyl, grooved pad, Ø 125 mm
VPAD-6	80126683	Vinyl, grooved pad, Ø 150 mm

Self generating vacuum system for 41-Series Sanders

Model No.	CPN	Description
4151JV	04662896	Vacuum system conversion kit
49988	04324455	Dust collection bags (20 pieces)
49987	04324448	Dust collection bags (250 pieces)

Technical Specifications

Model Number	Configuration	Type	Tool Weight (kg)	Tool Length (mm)	Height over Spindle (mm)
G Series Grinder					
G1A120PG4M	Angle	Collet	0.5	152	76
G1A200PG4M	Angle	Collet	0.5	152	76
G1H250PG4M	Straight	Collet	0.41	156	-
G1H350PG4M	Straight	Collet	0.41	156	-
G1X250PG4M	Straight Extended	Collet	0.59	232	-
G3A100PP96A	Angle	Wheel Type 27	2.2	245	92
G3A100PP96AV	Angle Piped Exhaust	Wheel Type 27	2.2	245	92
G3A120PP945A	Angle	Wheel Type 27	2.1	245	92
G3A120PP945AV	Angle Piped Exhaust	Wheel Type 27	2.1	245	92
G3A120PP95A	Angle	Wheel Type 27	2.1	245	92
G3A120PP95AV	Angle Piped Exhaust	Wheel Type 27	2.1	245	92
G3H150PG4M	Straight	Collet	1.36	230	-
G3H180PG4M	Straight	Collet	1.36	230	-
G3X150PG4M	Straight Extended	Collet	1.7	359	-
G3X180PG4M	Straight Extended	Collet	1.7	359	-
M Series Grinder					
M2A090RP95	Angle	Wheel Type 27	1.62	236	86.2
M2A120RG4	Angle	Collet	1.62	227	83.3
M2A120RP945	Angle	Wheel Type 27	1.71	236	86.2
M2A120RP95	Angle	Wheel Type 27	1.77	236	86.2
M2A180RG4	Angle	Collet	1.62	227	83.3
M2H180RG4	Straight	Collet	0.77	213	-
M2H200RG4	Straight	Collet	0.77	213	-
M2H250RG4	Straight	Collet	0.77	213	-
M2L025RS9	Angle	Sander (M14)	1.9	318	91
M2L040RS9	Angle	Sander (M14)	1.9	318	91
M2L055RS9	Angle	Sander (M14)	1.9	318	91
M2X075RG4	Extended Straight	Collet	1.35	304	-
M2X180RG4	Extended Straight	Collet	2.1	332	-
M2X180RH63	Horizontal Grinder	Wheel Type 1	1.48	339	-
M2X200RG4	Extended Straight	Collet	1.22	332	-
M2X250RG4	Extended Straight	Collet	2.68	332	-



Pneumatic Percussive Tools

- 48 | Air Impact Riveters
- 49 | Air Hammers and Reciprocating Saws
- 50 | Air Scalers and Needle Scalers
- 51 | Air Chippers

Ingersoll Rand offers a host of percussive tools to accomplish a variety of surface preparation tasks, whether heavy-duty or intricate in nature. We provide a wide line of riveters, cutting tools, scalers, needle scalers, chippers and accessories.

AVC-Series Impact Riveters

Ingersoll Rand lightweight riveters are time-tested performers for industrial riveting, hammering and cutting applications.

- Accurate and easily controlled tease throttle.
- Standard beehive retainer – allows use of wide variety of accessories.
- Built-in power regulators on A1 and B1 Models – the operator can change power on the job with no downtime.
- Available in straight, pistol, and gooseneck handles.



Technical Specifications at 6.2 bar (90 psi) dynamic pressure at inlet

Model No.	CPN	bpm	mm	mm	Aluminum mm	Dural & soft iron (mm)	kg	L mm	in (NPT)	mm	Max. l/s	dB(A)	m/s ² /K ⁽¹⁾
Straight Handle													
AVC10C1-EU	01341858	3,200	10.2	48	3	3	0.94	172	1/4"	8	5.7	92.0	13.3/1.9
Pistol Grip Handle													
AVC10A1-EU	01338995	3,200	10.2	48	3	3	1.28	152	1/4"	8	5.7	92.0	13.3/1.9
AVC12A1-EU	01338722	2,100	10.2	76	5	5	1.53	197	1/4"	8	6.0	91.1	8.0/1.8
AVC13A1-EU	01338078	1,725	10.2	101	6	6	1.67	222	1/4"	8	6.0	94.2	8.0/1.8
AVC26A1-EU	01339142	1,120	12.7	152	10	8	2.30	287	1/4"	13	6.6	92.6	8.0/1.8
Gooseneck handle													
AVC26B1-EU	01340926	1,120	12.7	152	10	8	3.20	354	1/4"	13	6.6	92.6	8.0/1.8

(1) ISO28927 – 3-axis measurement: vibration level/measurement uncertainty.

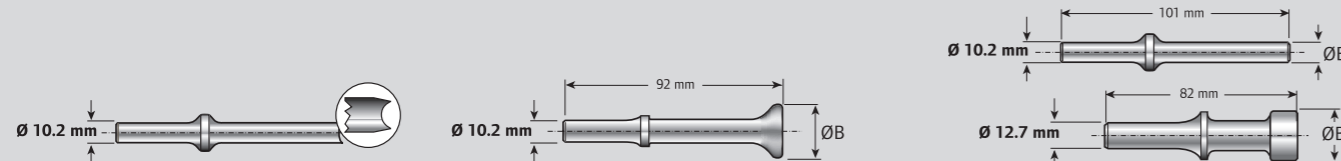

Brazier head jacket

Model No.	CPN	mm
AV1-22C-4	91136622	3 mm
AV1-22C-5	91136630	4 mm
AV1-22C-6	91136648	5 mm
AV1-22C-8	91136655	6 mm
AV1-22C-10	91136663	8 mm

Flush head jacket

Model No.	CPN	Ø B (mm)
AV1-126D	03218534	25

Beehive (safety) spring retainers

Model No.	CPN	Compatible tools
AVC1-83	03010659	All except AVC26
AVC24-283	03012010	AVC26

Jackset blank

Model No.	CPN	Shank Ø (mm)	Ø B (mm)
AV1-22S-16	03218062	10.2	13
AV1-22S-20	03218070	10.2	16
AV1-22S-24	03218088	10.2	19
AV1-22S-28	03218096	10.2	22
AV24-222S-26	03218724	12.7	21
AV24-222S-38	03218732	12.7	30

MAX-Series Hammers

Ingersoll Rand hammer will deliver the punch you need to get the job done fast and comfortably!

MAX Comfort: anti-vibration feature reduces tool vibration by over 30% when compared to standard air hammers in its class, plus, an ergonomic grip that provides comfort for extended use.

MAX Productivity: quick-change retainer allows for faster chisel changeovers, so you can get the job done.



Saws

Get a bigger bite and better cuts with Ingersoll Rand saws.

- Fast, quiet operation – Anti-vibration handle.
- Robust tools for heavy duty applications.



Technical Specifications at 6.2 bar (90 psi) dynamic pressure at inlet

Model No.	CPN Tool only	CPN Kit	bpm	mm ⁽¹⁾	mm	kg	L mm	in (NPT)	mm	Max. l/s	dB(A)	m/s ² /K ⁽²⁾
Air Hammers												
118MAX	47124490	47125877	2,500	10.2	89	2.10	314	1/4"	10	1.4	92.6	4.0/1.4
122MAX	47124482	47125869	3,500	10.2	67	1.80	218	1/4"	10	1.4	94.2	5.5/1.8
118MAXH	46816732	46816765	2,500	10.2	89	2.10	314	1/4"	10	1.4	92.6	4.0/1.4
122MAXH	46816740	46816757	3,500	10.2	67	1.80	218	1/4"	10	1.4	94.2	5.5/1.8
Saws												
4429	01371822	–	5,750	–	10	0.74	235	1/4"	6	3.6	66.2 ⁽³⁾	9.5/2.4
529	47125885	–	9,500	–	10	0.70	246	1/4"	6	0.5	84.3	3.1/1.0

(1) ○ = Round shank – □ = Hexagonal shank.

(2) ISO28927 – 3-axis measurement: vibration level/measurement uncertainty.

(3) Piped-away exhaust system.

Saw blades

Model No.	CPN	Description
P4FS-6	45525474	12 teeth/cm – Quantity 6
P4CS-6	45525508	10 teeth/cm – Quantity 6

Hammer accessories

Model No.	CPN	Description
9510	80167752	Replacement quick-change retainer
9500	80117427	Chisels, round shank (5 pieces)
116H-K5	92536093	Chisels, hexagonal shank (5 pieces)

172/182-Series Scalars

These scalars provide you with the means to aggressively prepare a surface for the next steps in an industrial surface preparation application. Whether its paint removal from the deck of a ship to rust removal from bridge girders, these tools get the job done quickly and efficiently.

- Proven designs and materials to ensure the toughest tools.
- Long nozzle sections extend retainer life and strengthened head blocks stand up to the hardest use.



Technical Specifications at 6.2 bar (90 psi) dynamic pressure at inlet

Model No.	CPN	bpm	mm	mm	kg	mm	in (NPT)	mm	Max. I/s	dB(A)	m/s ² /K ⁽²⁾
Chisel and Needle Scalars											
172L-EU	01337823	5,500	14	24	1.69	194	1/4"	8	5.7	107.5	11.6/2.6
172LNA1-EU	01337724	5,500	14	24	2.38	349	1/4"	8	5.7	107.5	12.5/1.8
182L-EU	01337625	4,000	27	24	1.84	229	1/4"	8	6.1	107.2	12.7/2.0
182G-EU	01339605	4,000	27	24	2.41	325	1/4"	8	6.1	107.2	8.5/1.2
182LNA1-EU	01337617	4,000	27	24	2.61	381	1/4"	8	6.1	107.2	10.1/1.7
182K1-EU	01337955	4,000	27	24	1.84/2.61	229/381	1/4"	8	6.1	107.2	12.7/2.0

(1) ISO28927 – 3-axis measurement: vibration level/measurement uncertainty.

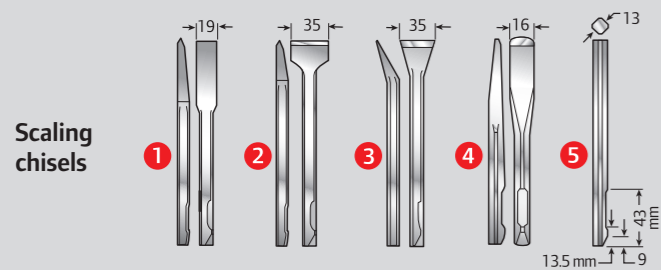

	Model No.	CPN	Length (mm)
1	WF-14F-7	03223948	178
1	WF-14F-12	92745629	305
2	WF-14B6 1/8	91136259	156
2	WF-14B-11 1/2	03223914	292
3	WF-14A-6 1/8	91136283	156
4	WF-14G-6	03223955	152
5	WF-14-7 1/8	03223872	181

Replacement needles (sets of 19 needles)

Model No.	CPN	Material	Needle length (mm)
NS11-22-19	03676335	Steel	127
NS11-B22-19	03676350	Beryllium copper	127
NS11-S22-19	03676343	Stainless steel	127
NS11-122-19	03676368	Steel	178

Attachment for conversion of models 172L and 182L

Model No.	CPN	Opening type	Needle length (mm)
NS11A	03468360	Round	127
NS11A7	03468394	Round	178
NS11B7	03468436	Rectangular	178

WA and SA Series Chippers

Renowned for its valve life and handle durability, this classic tool is widely used throughout industry. It is ideal for light demolition work, metal removal, form stripping, and many other applications.

- Swan neck handle with outside trigger.
- Time tested valve durability.
- Replaceable piston.
- Long nozzle for extra life.
- Grooved barrel, lock spring retainer on SA Series. Threaded barrel and rubber buffered retainer for increased steel and retainer life on WA-Series.



SA Series

Plain arrow retainer



WA Series

Rubber buffered retainer



Technical Specifications at 6.2 bar (90 psi) dynamic pressure at inlet

Model No.	CPN	bpm	mm (1)	mm	mm	kg	mm	in (NPT)	mm	Max. I/s	dB(A)	m/s ² /K ⁽²⁾
SA series/Plain Arrow Retainer												
1A2SA-EU	01341015	2,500	17	25	29	6.70	394	3/8"	13	13.2	109.9	18.1/5.4
2A2SA-EU	01339860	2,300	17	51	29	6.88	406	3/8"	13	13.2	109.8	18.0/5.4
3A2SA-EU	01342914	1,725	17	76	29	7.56	454	3/8"	13	13.7	112.2	17.7/5.3
4A2SA-EU	01341882	1,480	17	102	29	7.95	480	3/8"	13	13.7	112.9	18.9/6.2
1A1SA-EU	01340447	2,500	15	25	29	6.70	394	3/8"	13	13.2	109.9	18.1/5.4
2A1SA-EU	01339951	2,300	15	51	29	6.88	406	3/8"	13	13.2	109.8	18.0/5.4
3A1SA-EU	01340884	1,725	15	76	29	7.56	454	3/8"	13	13.7	112.2	17.7/5.3
4A1SA-EU	01340488	1,480	15	102	29	7.95	480	3/8"	13	13.7	112.9	18.9/6.2
WA Series/Rubber Buffered Retainer												
W1A2-EU	01341643	2,500	17	25	29	6.70	403	3/8"	13	13.2	109.9	17.5/5.8
W2A2-EU	01340207	2,300	17	51	29	6.88	416	3/8"	13	13.2	109.8	17.3/5.7
W3A2-EU	01340827	1,725	17	76	29	7.56	464	3/8"	13	13.7	112.2	13.7/4.5
W4A2-EU	01341106	1,480	17	102	29	7.95	489	3/8"	13	13.7	112.9	18.5/5.9
W1A1-EU	01339399	2,500	15	25	29	6.70	403	3/8"	13	13.2	109.9	17.5/5.8
W2A1-EU	01338649	2,300	15	51	29	6.88	416	3/8"	13	13.2	109.8	17.3/5.7
W3A1-EU	01340389	1,725	15	76	29	7.56	464	3/8"	13	13.7	112.2	13.7/4.5
W4A1-EU	01340215	1,480	15	102	29	7.95	489	3/8"	13	13.7	112.9	18.5/5.9

(1) ○ = Round shank — ◻ = Hexagonal shank.

(2) ISO28927 – 3-axis measurement: vibration level/measurement uncertainty.

Chisels for W and SA Series chippers

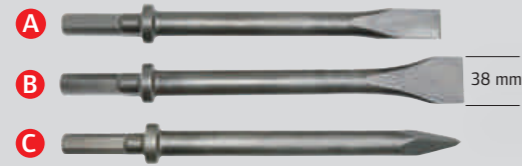

Round collar for rubber buffered retainer (for W Series)

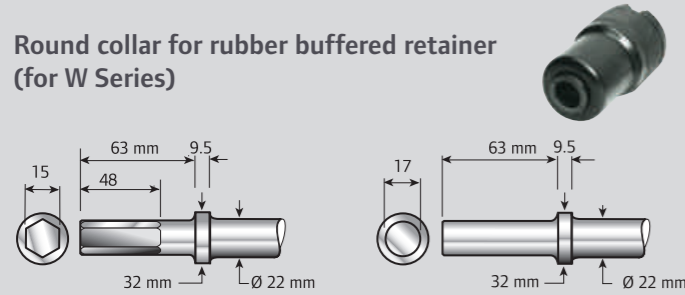

Oval collar for plain arrow retainer (for SA Series)

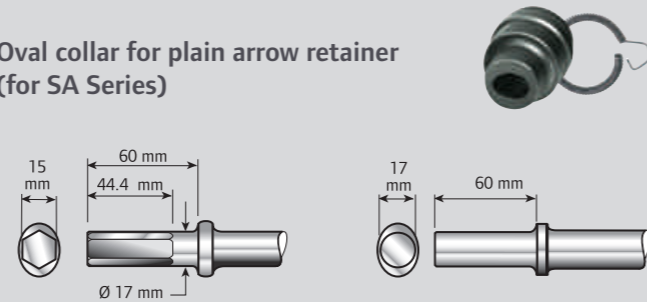

Model No.	CPN	Length (mm)	Weight (kg)
Round Shank			
A H3R-215F-12	03225661	305	0.8
A H3R-215F-18	03225687	455	1.1
A H3R-215F-24	03225703	610	1.3
A H3R-215F-36	03225729	915	2.4
B H3R-215B-12	03225745	305	0.8
C H3R-215M-12	03225596	305	0.8
C H3R-215M-18	92731769	455	1.1
C H3R-215M-24	56748650	610	1.3
Hexagonal Shank			
A H3R-214F-12	03225133	305	0.8
A H3R-214F-18	03225158	455	1.1
A H3R-214F-24	03225174	610	1.3
A H3R-214F-36	03225190	915	2.4
B H3R-214B-12	03225364	305	0.8
C H3R-214M-12	03225059	305	0.8
C H3R-214M-18	03225083	455	1.1
C H3R-214M-24	03225109	610	1.3
C H3R-214M-36	03225125	915	2.4

Model No.	CPN	Length (mm)	Weight (kg)
Round Shank			
A HH1-215F-12	03487923	305	0.8
A HH1-215F-18	03487931	455	1.1
A HH1-215F-24	03487949	610	1.3
A HH1-215F-36	03487956	915	2.4
B HH1-215B-12	91137075	305	0.8
C HH1-215M-12	91137034	305	0.8
C HH1-215M-18	03487972	455	1.1
C HH1-215M-24	03487980	610	1.3
Hexagonal Shank			
A HH1-214F-12	03221983	305	0.8
A HH1-214F-18	03487477	455	1.1
A HH1-214F-24	03487485	610	1.3
A HH1-214F-36	03487493	915	2.4
B HH1-214B-12	91137281	305	0.8
C HH1-214M-12	03222064	305	0.8
C HH1-214M-18	03487501	455	1.1
C HH1-214M-24	03487519	610	1.3
C HH1-214M-36	03487527	915	2.4

Notes

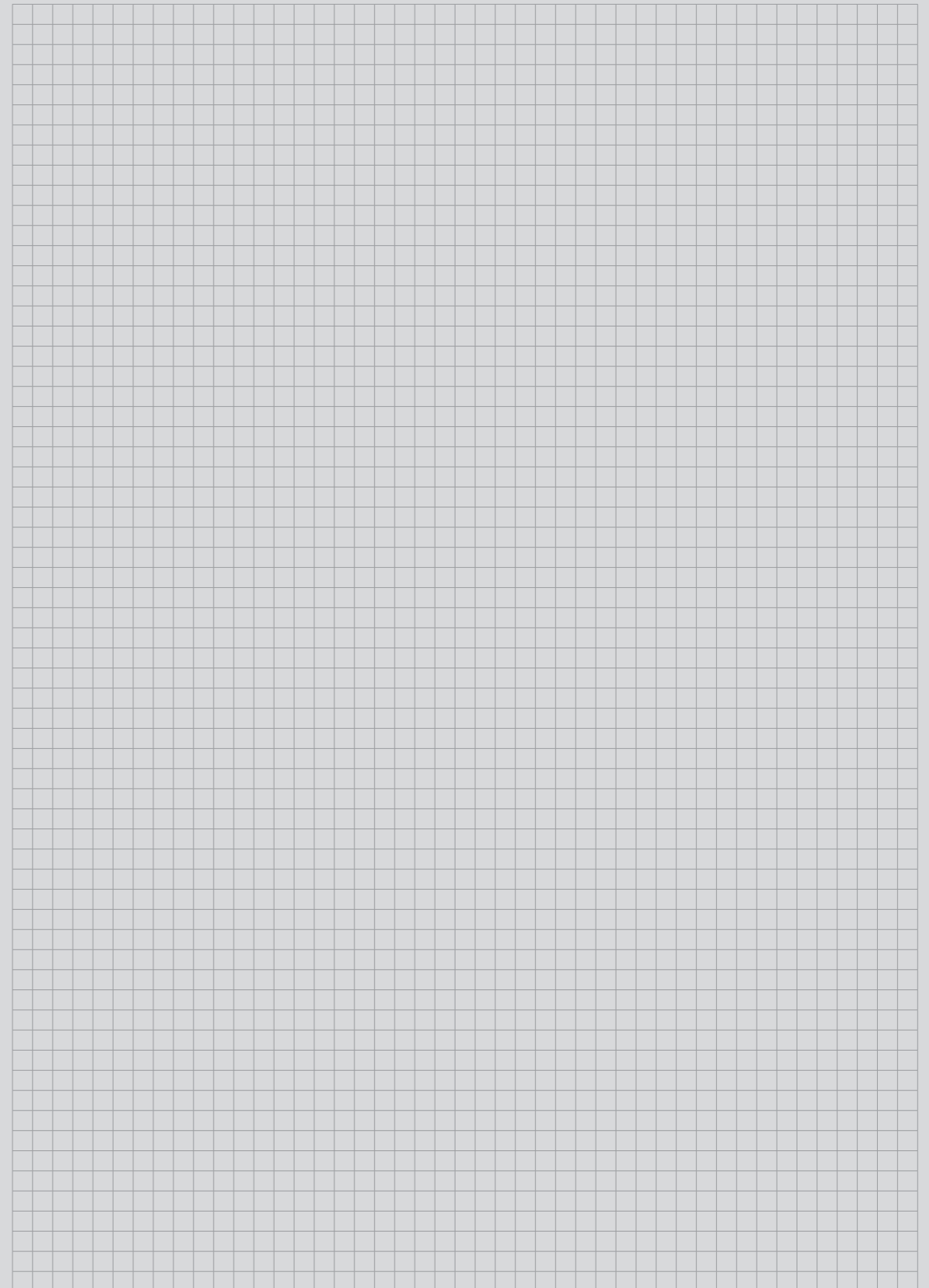



Airline & Additional Accessories

- 56 | Air Filters, Regulators and Lubricators
- 57 | Quick Release Couplings, Nipples and Hoses
- 59 | Spring Balancers – Tools Lubricants

Get the most out of your tools! Ingersoll Rand takes a systematic approach to providing a complete solution to maximize your productivity as efficiently and safely as possible. To that end, we have supplemented our line of tools with air line accessories, ergonomic accessories and tools lubricants.

Table with columns: Product, Page. Multiple columns listing various products and their corresponding page numbers.

Table with columns: Product, Page. Multiple columns listing various products and their corresponding page numbers.

Notes

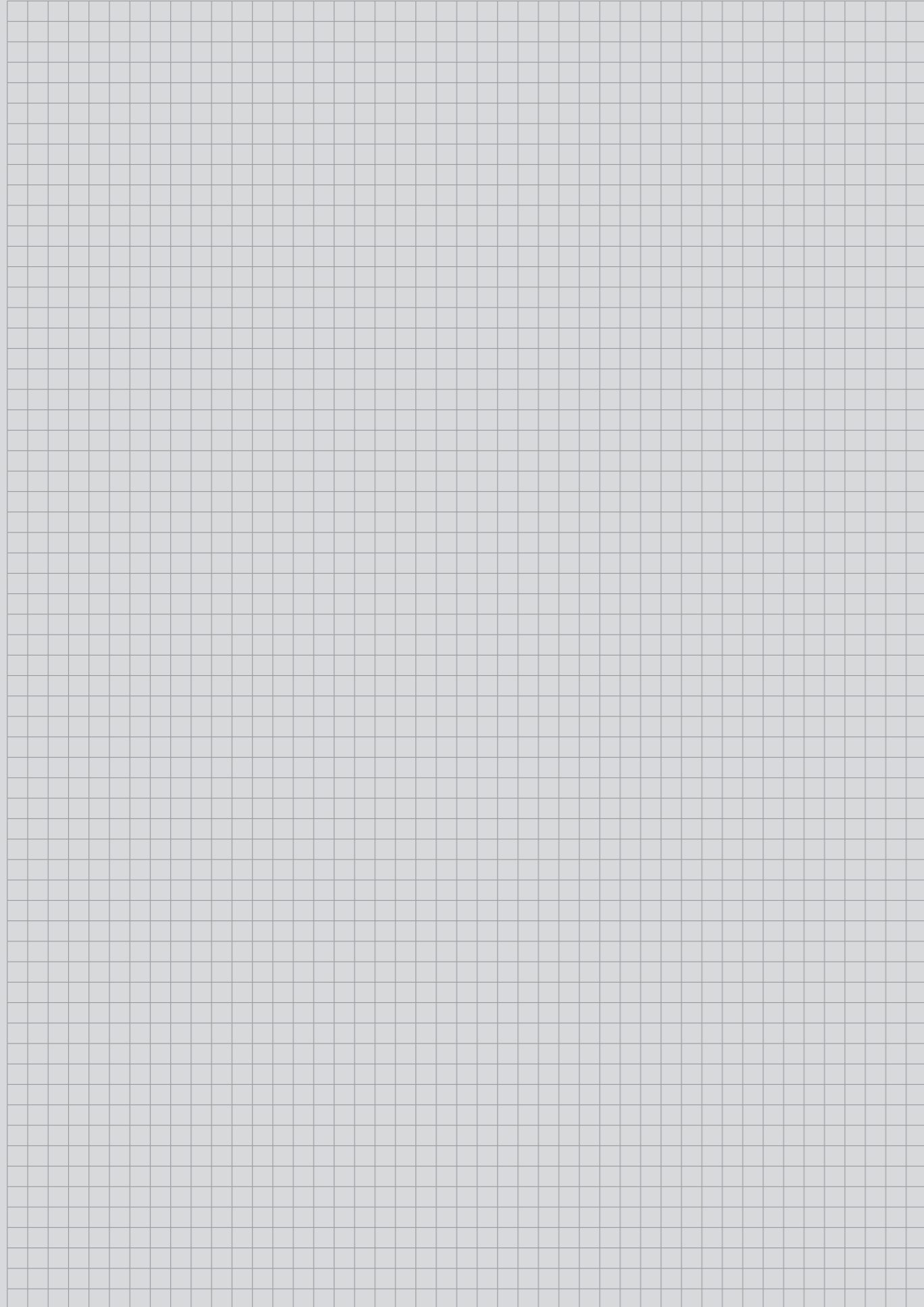

Notes

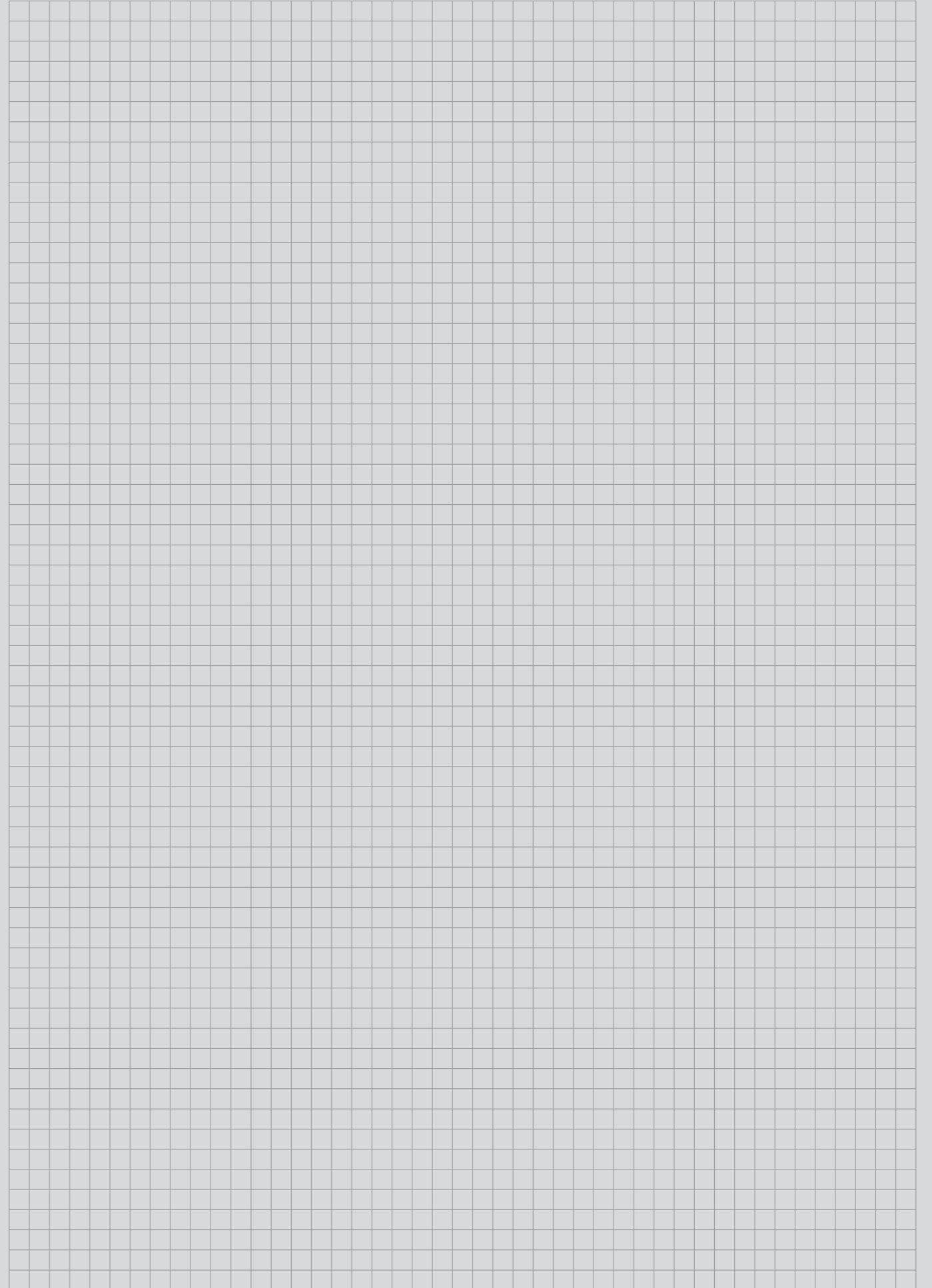



Ingersoll Rand (NYSE:IR) advances the quality of life by creating comfortable, sustainable and efficient environments. Our people and our family of brands — including Club Car®, Ingersoll Rand®, Thermo King® and Trane® — work together to enhance the quality and comfort of air in homes and buildings; transport and protect food and perishables; and increase industrial productivity and efficiency. We are a global business committed to a world of sustainable progress and enduring results.



[ingersollrandproducts.com](https://www.ingersollrandproducts.com)

We are committed to using environmentally conscious print practices.

Nothing contained on these pages is intended to extend any warranty or representation, expressed or implied, regarding the product described herein. Any such warranties or other terms and conditions of sale of product shall be in accordance with Ingersoll Rand's standard terms and conditions of sale for such products, which are available upon request. Product improvement is a continuing goal at Ingersoll Rand. Designs and specifications are subject to change without notice or obligation.